Project Management Institute

A GUIDE TO THE PROJECT MANAGEMENT BODY OF KNOWLEDGE

(PMBOK® Guide) – Fifth Edition

Library of Congress Cataloging-in-Publication Data

A guide to the project management body of knowledge (*PMBOK® guide*). -- Fifth edition.

pages cm

Includes bibliographical references and index.

ISBN 978-1-935589-67-9 (pbk. : alk. paper)

1. Project management. I. Project Management Institute. II. Title: PMBOK guide.

HD69.P75G845 2013

658.4'04--dc23

2012046112

ISBN: 978-1-935589-67-9

Published by:

Project Management Institute, Inc.

14 Campus Boulevard

Newtown Square, Pennsylvania 19073-3299 USA

Phone: +610-356-4600

Fax: +610-356-4647

Email: customercare@pmi.org

Internet: www.PMI.org

©2013 Project Management Institute, Inc. All rights reserved.

“PMI”, the PMI logo, “PMP”, the PMP logo, “PMBOK”, “PgMP”, “Project Management Journal”, “PM Network”, and the PMI Today logo are registered marks of Project Management Institute, Inc. The Quarter Globe Design is a trademark of the Project Management Institute, Inc. For a comprehensive list of PMI marks, contact the PMI Legal Department.

PMI Publications welcomes corrections and comments on its books. Please feel free to send comments on typographical, formatting, or other errors. Simply make a copy of the relevant page of the book, mark the error, and send it to: Book Editor, PMI Publications, 14 Campus Boulevard, Newtown Square, PA 19073-3299 USA.

To inquire about discounts for resale or educational purposes, please contact the PMI Book Service Center.

PMI Book Service Center

P.O. Box 932683, Atlanta, GA 31193-2683 USA

Phone: 1-866-276-4764 (within the U.S. or Canada) or +1-770-280-4129 (globally)

Fax: +1-770-280-4113

Email: info@bookorders.pmi.org

Printed in the United States of America. No part of this work may be reproduced or transmitted in any form or by any means, electronic, manual, photocopying, recording, or by any information storage and retrieval system, without prior written permission of the publisher.

The paper used in this book complies with the Permanent Paper Standard issued by the National Information Standards Organization (Z39.48—1984).

10 9 8 7 6 5 4 3 2 1

NOTICE

The Project Management Institute, Inc. (PMI) standards and guideline publications, of which the document contained herein is one, are developed through a voluntary consensus standards development process. This process brings together volunteers and/or seeks out the views of persons who have an interest in the topic covered by this publication. While PMI administers the process and establishes rules to promote fairness in the development of consensus, it does not write the document and it does not independently test, evaluate, or verify the accuracy or completeness of any information or the soundness of any judgments contained in its standards and guideline publications.

PMI disclaims liability for any personal injury, property or other damages of any nature whatsoever, whether special, indirect, consequential or compensatory, directly or indirectly resulting from the publication, use of application, or reliance on this document. PMI disclaims and makes no guaranty or warranty, expressed or implied, as to the accuracy or completeness of any information published herein, and disclaims and makes no warranty that the information in this document will fulfill any of your particular purposes or needs. PMI does not undertake to guarantee the performance of any individual manufacturer or seller's products or services by virtue of this standard or guide.

In publishing and making this document available, PMI is not undertaking to render professional or other services for or on behalf of any person or entity, nor is PMI undertaking to perform any duty owed by any person or entity to someone else. Anyone using this document should rely on his or her own independent judgment or, as appropriate, seek the advice of a competent professional in determining the exercise of reasonable care in any given circumstances. Information and other standards on the topic covered by this publication may be available from other sources, which the user may wish to consult for additional views or information not covered by this publication.

PMI has no power, nor does it undertake to police or enforce compliance with the contents of this document. PMI does not certify, test, or inspect products, designs, or installations for safety or health purposes. Any certification or other statement of compliance with any health or safety-related information in this document shall not be attributable to PMI and is solely the responsibility of the certifier or maker of the statement.

TABLE OF CONTENTS

1. INTRODUCTION	1
1.1 Purpose of the <i>PMBOK® Guide</i>	2
1.2 What is a Project?	3
1.2.1. The Relationships Among Portfolios, Programs, and Projects	4
1.3 What is Project Management?	5
1.4 Relationships Among Portfolio Management, Program Management, Project Management, and Organizational Project Management	7
1.4.1 Program Management	9
1.4.2 Portfolio Management	9
1.4.3 Projects and Strategic Planning	10
1.4.4 Project Management Office	10
1.5 Relationship Between Project Management, Operations Management, and Organizational Strategy	12
1.5.1 Operations and Project Management	12
1.5.2 Organizations and Project Management	14
1.6 Business Value	15
1.7 Role of the Project Manager	16
1.7.1 Responsibilities and Competencies of the Project Manager	17
1.7.2 Interpersonal Skills of a Project Manager	17
1.8 Project Management Body of Knowledge	18
2. ORGANIZATIONAL INFLUENCES AND PROJECT LIFE CYCLE	19
2.1 Organizational Influences on Project Management	20
2.1.1 Organizational Cultures and Styles	20
2.1.2 Organizational Communications	21
2.1.3 Organizational Structures	21
2.1.4 Organizational Process Assets	27
2.1.5 Enterprise Environmental Factors	29

2.2 Project Stakeholders and Governance	30
2.2.1 Project Stakeholders.....	30
2.2.2 Project Governance.....	34
2.2.3 Project Success.....	35
2.3 Project Team	35
2.3.1 Composition of Project Teams.....	37
2.4 Project Life Cycle.....	38
2.4.1 Characteristics of the Project Life Cycle.....	38
2.4.2 Project Phases.....	41
3. PROJECT MANAGEMENT PROCESSES	47
3.1 Common Project Management Process Interactions.....	50
3.2 Project Management Process Groups	52
3.3 Initiating Process Group.....	54
3.4 Planning Process Group.....	55
3.5 Executing Process Group	56
3.6 Monitoring and Controlling Process Group	57
3.7 Closing Process Group	57
3.8 Project Information.....	58
3.9 Role of the Knowledge Areas	60
4. PROJECT INTEGRATION MANAGEMENT	63
4.1 Develop Project Charter	66
4.1.1 Develop Project Charter: Inputs.....	68
4.1.2 Develop Project Charter: Tools and Techniques.....	71
4.1.3 Develop Project Charter: Outputs	71
4.2 Develop Project Management Plan.....	72
4.2.1 Develop Project Management Plan: Inputs	74
4.2.2 Develop Project Management Plan: Tools and Techniques	76
4.2.3 Develop Project Management Plan: Outputs.....	76

4.3 Direct and Manage Project Work	79
4.3.1 Direct and Manage Project Work: Inputs	82
4.3.2 Direct and Manage Project Work: Tools and Techniques	83
4.3.3 Direct and Manage Project Work: Outputs	84
4.4 Monitor and Control Project Work	86
4.4.1 Monitor and Control Project Work: Inputs.....	88
4.4.2 Monitor and Control Project Work: Tools and Techniques.....	91
4.4.3 Monitor and Control Project Work: Outputs	92
4.5 Perform Integrated Change Control	94
4.5.1 Perform Integrated Change Control: Inputs	97
4.5.2 Perform Integrated Change Control: Tools and Techniques	98
4.5.3 Perform Integrated Change Control: Outputs.....	99
4.6 Close Project or Phase	100
4.6.1 Close Project or Phase: Inputs.....	102
4.6.2 Close Project or Phase: Tools and Techniques.....	102
4.6.3 Close Project or Phase: Outputs	103
5. PROJECT SCOPE MANAGEMENT	105
5.1 Plan Scope Management.....	107
5.1.1 Plan Scope Management: Inputs.....	108
5.1.2 Plan Scope Management: Tools and Techniques.....	109
5.1.3 Plan Scope Management: Outputs	109
5.2 Collect Requirements	110
5.2.1 Collect Requirements: Inputs	113
5.2.2 Collect Requirements: Tools and Techniques	114
5.2.3 Collect Requirements: Outputs.....	117
5.3 Define Scope.....	120
5.3.1 Define Scope: Inputs	121
5.3.2 Define Scope: Tools and Techniques	122
5.3.3 Define Scope: Outputs.....	123

5.4 Create WBS	125
5.4.1 Create WBS: Inputs	127
5.4.2 Create WBS: Tools and Techniques	128
5.4.3 Create WBS: Outputs	131
5.5 Validate Scope	133
5.5.1 Validate Scope: Inputs	134
5.5.2 Validate Scope: Tools and Techniques	135
5.5.3 Validate Scope: Outputs	135
5.6 Control Scope	136
5.6.1 Control Scope: Inputs	138
5.6.2 Control Scope: Tools and Techniques	139
5.6.3 Control Scope: Outputs	139
6. PROJECT TIME MANAGEMENT	141
6.1 Plan Schedule Management	145
6.1.1 Plan Schedule Management: Inputs	146
6.1.2 Plan Schedule Management: Tools and Techniques	147
6.1.3 Plan Schedule Management: Outputs	148
6.2 Define Activities	149
6.2.1 Define Activities: Inputs	150
6.2.2 Define Activities: Tools and Techniques	151
6.2.3 Define Activities: Outputs	152
6.3 Sequence Activities	153
6.3.1 Sequence Activities: Inputs	154
6.3.2 Sequence Activities: Tools and Techniques	156
6.3.3 Sequence Activities: Outputs	159
6.4 Estimate Activity Resources	160
6.4.1 Estimate Activity Resources: Inputs	162
6.4.2 Estimate Activity Resources: Tools and Techniques	164
6.4.3 Estimate Activity Resources: Outputs	165

6.5 Estimate Activity Durations	165
6.5.1 Estimate Activity Durations: Inputs	167
6.5.2 Estimate Activity Durations: Tools and Techniques	169
6.5.3 Estimate Activity Durations: Outputs	172
6.6 Develop Schedule	172
6.6.1 Develop Schedule: Inputs	174
6.6.2 Develop Schedule: Tools and Techniques	176
6.6.3 Develop Schedule: Outputs	181
6.7 Control Schedule	185
6.7.1 Control Schedule: Inputs	187
6.7.2 Control Schedule: Tools and Techniques	188
6.7.3 Control Schedule: Outputs	190
7. PROJECT COST MANAGEMENT	193
7.1 Plan Cost Management	195
7.1.1 Plan Cost Management: Inputs	196
7.1.2 Plan Cost Management: Tools and Techniques	198
7.1.3 Plan Cost Management: Outputs	198
7.2 Estimate Costs	200
7.2.1 Estimate Costs: Inputs	202
7.2.2 Estimate Costs: Tools and Techniques	204
7.2.3 Estimate Costs: Outputs	207
7.3 Determine Budget	208
7.3.1 Determine Budget: Inputs	209
7.3.2 Determine Budget: Tools and Techniques	211
7.3.3 Determine Budget: Outputs	212
7.4 Control Costs	215
7.4.1 Control Costs: Inputs	216
7.4.2 Control Costs: Tools and Techniques	217
7.4.3 Control Costs: Outputs	225

8. PROJECT QUALITY MANAGEMENT	227
8.1 Plan Quality Management	231
8.1.1 Plan Quality Management: Inputs	233
8.1.2 Plan Quality Management: Tools and Techniques	235
8.1.3 Plan Quality Management: Outputs	241
8.2 Perform Quality Assurance	242
8.2.1 Perform Quality Assurance: Inputs.....	244
8.2.2 Perform Quality Assurance: Tools and Techniques.....	245
8.2.3 Perform Quality Assurance: Outputs	247
8.3 Control Quality	248
8.3.1 Control Quality: Inputs	250
8.3.2 Control Quality: Tools and Techniques	252
8.3.3 Control Quality: Outputs.....	252
9. PROJECT HUMAN RESOURCE MANAGEMENT	255
9.1 Plan Human Resource Management	258
9.1.1 Plan Human Resource Management: Inputs.....	259
9.1.2 Plan Human Resource Management: Tools and Techniques.....	261
9.1.3 Plan Human Resource Management: Outputs	264
9.2 Acquire Project Team	267
9.2.1 Acquire Project Team: Inputs.....	269
9.2.2 Acquire Project Team: Tools and Techniques.....	270
9.2.3 Acquire Project Team: Outputs	272
9.3 Develop Project Team	273
9.3.1 Develop Project Team: Inputs	274
9.3.2 Develop Project Team: Tools and Techniques	275
9.3.3 Develop Project Team: Outputs.....	278
9.4 Manage Project Team	279
9.4.1 Manage Project Team: Inputs	281
9.4.2 Manage Project Team: Tools and Techniques	282
9.4.3 Manage Project Team: Outputs.....	284

10. PROJECT COMMUNICATIONS MANAGEMENT	287
10.1 Plan Communications Management.....	289
10.1.1 Plan Communications Management: Inputs	290
10.1.2 Plan Communications Management: Tools and Techniques	291
10.1.3 Plan Communications Management: Outputs.....	296
10.2 Manage Communications	297
10.2.1 Manage Communications: Inputs.....	299
10.2.2 Manage Communications: Tools and Techniques.....	300
10.2.3 Manage Communications: Outputs	301
10.3 Control Communications.....	303
10.3.1 Control Communications: Inputs	304
10.3.2 Control Communications: Tools and Techniques	306
10.3.3 Control Communications: Outputs.....	307
11. PROJECT RISK MANAGEMENT	309
11.1 Plan Risk Management	313
11.1.1 Plan Risk Management: Inputs.....	314
11.1.2 Plan Risk Management: Tools and Techniques.....	315
11.1.3 Plan Risk Management: Outputs	316
11.2 Identify Risks.....	319
11.2.1 Identify Risks: Inputs	321
11.2.2 Identify Risks: Tools and Techniques	324
11.2.3 Identify Risks: Outputs.....	327
11.3 Perform Qualitative Risk Analysis	328
11.3.1 Perform Qualitative Risk Analysis: Inputs.....	329
11.3.2 Perform Qualitative Risk Analysis: Tools and Techniques.....	330
11.3.3 Perform Qualitative Risk Analysis: Outputs	333
11.4 Perform Quantitative Risk Analysis	333
11.4.1 Perform Quantitative Risk Analysis: Inputs	335
11.4.2 Perform Quantitative Risk Analysis: Tools and Techniques	336
11.4.3 Perform Quantitative Risk Analysis: Outputs	341

11.5 Plan Risk Responses	342
11.5.1 Plan Risk Responses: Inputs	343
11.5.2 Plan Risk Responses: Tools and Techniques	343
11.5.3 Plan Risk Responses: Outputs	346
11.6 Control Risks	349
11.6.1 Control Risks: Inputs	350
11.6.2 Control Risks: Tools and Techniques	351
11.6.3 Control Risks: Outputs	353
12. PROJECT PROCUREMENT MANAGEMENT	355
12.1 Plan Procurement Management	358
12.1.1 Plan Procurement Management: Inputs	360
12.1.2 Plan Procurement Management: Tools and Techniques	365
12.1.3 Plan Procurement Management: Outputs	366
12.2 Conduct Procurements	371
12.2.1 Conduct Procurements: Inputs	373
12.2.2 Conduct Procurements: Tools and Techniques	375
12.2.3 Conduct Procurements: Outputs	377
12.3 Control Procurements	379
12.3.1 Control Procurements: Inputs	381
12.3.2 Control Procurements: Tools and Techniques	383
12.3.3 Control Procurements: Outputs	384
12.4 Close Procurements	386
12.4.1 Close Procurements: Inputs	388
12.4.2 Close Procurements: Tools and Techniques	388
12.4.3 Close Procurements: Outputs	389
13. PROJECT STAKEHOLDER MANAGEMENT	391
13.1 Identify Stakeholders	393
13.1.1 Identify Stakeholders: Inputs	394
13.1.2 Identify Stakeholders: Tools and Techniques	395
13.1.3 Identify Stakeholders: Outputs	398

13.2 Plan Stakeholder Management.....	399
13.2.1 Plan Stakeholder Management: Inputs	400
13.2.2 Plan Stakeholder Management: Tools and Techniques	401
13.2.3 Plan Stakeholder Management: Outputs.....	403
13.3 Manage Stakeholder Engagement.....	404
13.3.1 Manage Stakeholder Engagement: Inputs	406
13.3.2 Manage Stakeholder Engagement: Tools and Techniques	407
13.3.3 Manage Stakeholder Engagement: Outputs.....	408
13.4 Control Stakeholder Engagement	409
13.4.1 Control Stakeholder Engagement: Inputs	411
13.4.2 Control Stakeholder Engagement: Tools and Techniques	412
13.4.3 Control Stakeholder Engagement: Outputs.....	413
ANNEX A1 THE STANDARD FOR PROJECT MANAGEMENT OF A PROJECT.....	417
APPENDIX X1 FIFTH EDITION CHANGES	463
APPENDIX X2 CONTRIBUTORS AND REVIEWERS OF THE <i>PMBOK® GUIDE –</i>	
FIFTH EDITION	483
APPENDIX X3 INTERPERSONAL SKILLS.....	513
REFERENCES	521
GLOSSARY.....	523
INDEX	569

LIST OF TABLES AND FIGURES

Figure 1-1.	Portfolio, Program, and Project Management Interactions.....	5
Figure 2-1.	Functional Organization	22
Figure 2-2.	Weak Matrix Organization	23
Figure 2-3.	Balanced Matrix Organization.....	24
Figure 2-4.	Strong Matrix Organization	24
Figure 2-5.	Projectized Organization	25
Figure 2-6.	Composite Organization	26
Figure 2-7.	The Relationship Between Stakeholders and the Project.....	31
Figure 2-8.	Typical Cost and Staffing Levels Across a Generic Project Life Cycle Structure	39
Figure 2-9.	Impact of Variable Based on Project Time	40
Figure 2-10.	Example of a Single-Phase Project.....	42
Figure 2-11.	Example of a Three-Phase Project.....	43
Figure 2-12.	Example of a Project with Overlapping Phases.....	43
Figure 2-13.	Example of Predictive Life Cycle.....	44
Figure 3-1.	Project Management Process Groups.....	50
Figure 3-2.	Process Groups Interact in a Phase or Project.....	51
Figure 3-3.	Project Management Process Interactions	53
Figure 3-4.	Project Boundaries	54
Figure 3-5.	Project Data, Information and Report Flow	59
Figure 3-6.	Data Flow Diagram Legend	60
Figure 4-1.	Project Integration Management Overview	65

Figure 4-2.	Develop Project Charter: Inputs, Tools and Techniques, and Outputs	66
Figure 4-3.	Develop Project Charter Data Flow Diagram	67
Figure 4-3.	Develop Project Charter Data Flow Diagram	72
Figure 4-5.	Develop Project Management Plan Data Flow Diagram	73
Figure 4-6.	Direct and Manage Project Work: Inputs, Tools and Techniques, and Outputs.....	79
Figure 4-7.	Direct and Manage Project Work: Data Flow Diagram.....	80
Figure 4-8.	Monitor and Control Project Work: Inputs, Tools & Techniques, and Outputs.....	86
Figure 4-9.	Monitor and Control Project Work Data Flow Diagram	87
Figure 4-10.	Perform Integrated Change Control: Inputs, Tools & Techniques, and Outputs	94
Figure 4-11.	Perform Integrated Change Control Data Flow Diagram.....	95
Figure 4-12.	Close Project or Phase: Inputs, Tools & Techniques, and Outputs.....	100
Figure 4-13.	Close Project or Phase Data Flow Diagram	101
Figure 5-1.	Project Scope Management Overview	106
Figure 5-2.	Plan Scope Management: Inputs, Tools & Techniques, and Outputs.....	107
Figure 5-3.	Plan Scope Management Data Flow Diagram	107
Figure 5-4.	Collect Requirements: Inputs, Tools & Techniques, and Outputs	111
Figure 5-5.	Collect Requirements Data Flow Diagram.....	111
Figure 5-6.	Example of a Requirements Traceability Matrix.....	119
Figure 5-7.	Define Scope: Inputs, Tools & Techniques, and Outputs	120
Figure 5-8.	Define Scope Data Flow Diagram	120
Figure 5-9.	Create WBS: Inputs, Tools & Techniques, and Outputs	125
Figure 5-10.	Create WBS Data Flow Diagram.....	126

Figure 5-11.	Sample WBS Decomposed Down Through Work Packages.....	129
Figure 5-12.	Sample WBS Organized by Phase	130
Figure 5-13.	Sample WBS with Major Deliverables.....	130
Figure 5-14.	Validate Scope: Inputs, Tools & Techniques, and Outputs	133
Figure 5-15.	Validate Scope Data Flow Diagram.....	133
Figure 5-16.	Control Scope: Inputs, Tools & Techniques, and Outputs.....	136
Figure 5-17.	Control Scope Data Flow Diagram	137
Figure 6-1.	Project Time Management Overview	143
Figure 6-2.	Scheduling Overview	144
Figure 6-3.	Plan Schedule Management: Inputs, Tools & Techniques, and Outputs.....	145
Figure 6-4.	Plan Schedule Management Data Flow Diagram	145
Figure 6-5.	Define Activities: Inputs, Tools & Techniques, and Outputs	149
Figure 6-6.	Define Activities Data Flow Diagram	150
Figure 6-7.	Sequence Activities: Inputs, Tools & Techniques, and Outputs	153
Figure 6-8.	Sequence Activities Data Flow Diagram.....	154
Figure 6-9.	Precedence Diagramming Method (PDM) Relationship Types	157
Figure 6-10.	Examples of Lead and Lag	158
Figure 6-11.	Project Schedule Network Diagram.....	160
Figure 6-12.	Estimate Activity Resources: Inputs, Tools & Techniques, and Outputs.....	161
Figure 6-13.	Estimate Activity Resources Data Flow Diagram.....	161
Figure 6-14.	Estimate Activity Durations: Inputs, Tools & Techniques, and Outputs.....	166
Figure 6-15.	Estimate Activity Durations Data Flow Diagram	166

Figure 6-16	Develop Schedule: Inputs, Tools & Techniques, and Outputs	173
Figure 6-17.	Develop Schedule Data Flow Diagram.....	173
Figure 6-18.	Example of Critical Path Method.....	177
Figure 6-19.	Example of Critical Chain Method.....	178
Figure 6-20.	Resource Leveling	179
Figure 6-21.	Project Schedule Presentations —Examples	183
Figure 6-22.	Control Schedule: Inputs, Tools & Techniques, and Outputs.....	185
Figure 6-23.	Control Schedule Data Flow Diagram	186
Figure 7-1.	Project Cost Management Overview.....	194
Figure 7-2.	Plan Cost Management: Inputs, Tools & Techniques, and Outputs.....	195
Figure 7-3.	Plan Cost Management: Data Flow Diagram	196
Figure 7-4.	Estimate Costs: Inputs, Tools & Techniques, and Outputs	200
Figure 7-5.	Estimate Costs Data Flow Diagram.....	201
Figure 7-6.	Determine Budget: Inputs, Tools & Techniques, and Outputs.....	208
Figure 7-7.	Determine Budget Data Flow Diagram	209
Figure 7-8.	Project Budget Components.....	213
Figure 7-9.	Cost Baseline, Expenditures, and Funding Requirements	214
Figure 7-10.	Control Costs: Inputs, Tools & Techniques, and Outputs.....	215
Figure 7-11.	Control Costs Data Flow Diagram	215
Figure 7-12.	Earned Value, Planned Value, and Actual Costs	219
Figure 7-13.	To-Complete Performance Index (TCPI).....	222

Figure 8-1.	Project Quality Management Overview.....	230
Figure 8-2.	Fundamental Relationships of Quality Assurance and Control Quality to the IPECC, PDCA, Cost of Quality Models and Project Management Process Groups.....	231
Figure 8-3.	Plan Quality Management Inputs, Tools & Techniques, and Outputs	232
Figure 8-4.	Plan Quality Management Data Flow Diagram.....	232
Figure 8-5.	Cost of Quality.....	235
Figure 8-6.	The SIPOC Model.....	237
Figure 8-7.	Storyboard Illustrating a Conceptual Example of Each of the Seven Basic Quality Tools	239
Figure 8-8.	Perform Quality Assurance: Inputs, Tools & Techniques, and Outputs.....	243
Figure 8-9.	Perform Quality Assurance Data Flow Diagram	243
Figure 8-10.	Storyboard Illustrating the Seven Quality Management and Control Tools	246
Figure 8-11.	Control Quality: Inputs, Tools & Techniques, and Outputs	249
Figure 8-12.	Control Quality Data Flow Diagram.....	249
Figure 9-1.	Project Human Resource Management Overview	257
Figure 9-2.	Plan Human Resource Management: Inputs, Tools & Techniques, and Outputs.....	258
Figure 9-3.	Plan Human Resource Management Data Flow Diagram	258
Figure 9-4.	Roles and Responsibility Definition Formats.....	261
Figure 9-5.	RACI Matrix	262
Figure 9-6.	Illustrative Resource Histogram.....	266
Figure 9-7.	Acquire Project Team: Inputs, Tools & Techniques, and Outputs.....	267
Figure 9-8.	Acquire Project Team Data Flow Diagram.....	268

Figure 9-9.	Develop Project Team: Inputs, Tools & Techniques, and Outputs	273
Figure 9-10.	Develop Project Team Data Flow Diagram	273
Figure 9-11.	Manage Project Team: Inputs, Tools & Techniques, and Outputs	279
Figure 9-12.	Manage Project Team Data Flow Diagram	280
Figure 10-1.	Project Communications Management Overview	288
Figure 10-2.	Plan Communications Management: Inputs, Tools & Techniques, and Outputs	289
Figure 10-3.	Plan Communications Management Data Flow Diagram	289
Figure 10-4.	Basic Communication Model	294
Figure 10-5.	Manage Communications: Inputs, Tools & Techniques, and Outputs.....	297
Figure 10-6.	Manage Communications Data Flow Diagram	298
Figure 10-7.	Control Communications: Inputs, Tools & Techniques, and Outputs	303
Figure 10-8.	Control Communications Data Flow Diagram	304
Figure 11-1.	Project Risk Management Overview	312
Figure 11-2.	Plan Risk Management: Inputs, Tools & Techniques, and Outputs.....	313
Figure 11-3.	Plan Risk Management Data Flow Diagram	313
Figure 11-4.	Example of a Risk Breakdown Structure (RBS).....	317
Figure 11-5.	Identify Risks: Inputs, Tools & Techniques, and Outputs	319
Figure 11-6.	Identify Risks Data Flow Diagram.....	320
Figure 11-7.	Influence Diagram	326
Figure 11-8.	Perform Qualitative Risk Analysis: Inputs, Tools & Techniques, and Outputs.....	328
Figure 11-9.	Perform Qualitative Risk Analysis Data Flow Diagram	328
Figure 11-10.	Probability and Impact Matrix.....	331

Figure 11-11. Perform Quantitative Risk Analysis: Inputs, Tools & Techniques, and Outputs	334
Figure 11-12. Perform Quantitative Risk Analysis Data Flow Diagram.....	334
Figure 11-13. Range of Project Cost Estimates Collected During the Risk Interview	336
Figure 11-14. Examples of Commonly Used Probability Distributions.....	337
Figure 11-15. Example of Tornado Diagram	338
Figure 11-16. Decision Tree Diagram	339
Figure 11-17. Cost Risk Simulation Results	340
Figure 11-18. Plan Risk Responses: Inputs, Tools & Techniques, and Outputs	342
Figure 11-19. Plan Risk Responses Data Flow Diagram.....	342
Figure 11-20. Control Risks: Inputs, Tools & Techniques, and Outputs.....	349
Figure 11-21. Control Risks Data Flow Diagram	349
Figure 12-1. Project Procurement Management Overview.....	356
Figure 12-2. Plan Procurements: Inputs, Tools & Techniques, and Outputs	358
Figure 12-3. Plan Procurement Management Data Flow Diagram.....	359
Figure 12-4. Conduct Procurements: Inputs, Tools & Techniques, and Outputs	371
Figure 12-5. Conduct Procurements Data Flow Diagram	372
Figure 12-6. Control Procurements: Inputs, Tools & Techniques, and Outputs.....	379
Figure 12-7. Control Procurements Data Flow Diagram	380
Figure 12-8. Close Procurements: Inputs, Tools & Techniques, and Outputs.....	386
Figure 12-9. Close Procurements Data Flow Diagram.....	387
Figure 13-1. Project Stakeholder Management Overview	392
Figure 13-2. Identify Stakeholders: Inputs, Tools & Techniques, and Outputs.....	393

Figure 13-3. Identify Stakeholders Data Flow Diagram	393
Figure 13-4. Example Power/Interest Grid with Stakeholders	397
Figure 13-5. Plan Stakeholder Management: Inputs, Tools & Techniques, and Outputs	399
Figure 13-6. Plan Stakeholder Management Data Flow Diagram	399
Figure 13-7. Stakeholders Engagement Assessment Matrix	403
Figure 13-8. Manage Stakeholder Engagement: Inputs, Tools & Techniques, and Outputs	404
Figure 13-9. Manage Stakeholder Engagement Data Flow Diagram	405
Figure 13-10. Control Stakeholder Engagement: Inputs, Tools & Techniques, and Outputs	410
Figure 13-11. Control Stakeholder Engagement: Data Flow Diagram	410
Figure A1-1. Process Group Interactions in a Project	419
Figure A1-2. Project Management Process Interactions	421
Figure A1-3. Project Boundaries	425
Figure A1-4. Initiating Process Group	425
Figure A1-5. Develop Project Charter: Inputs and Outputs	426
Figure A1-6. Identify Stakeholders: Inputs and Outputs	426
Figure A1-7. Planning Process Group	428
Figure A1-8. Develop Project Management Plan: Inputs and Outputs	429
Figure A1-9. Plan Scope Management: Inputs and Outputs	429
Figure A1-10. Collect Requirements: Inputs and Outputs	430
Figure A1-11. Define Scope: Inputs and Outputs	430
Figure A1-12. Create WBS: Inputs and Outputs	431
Figure A1-13. Plan Schedule Management: Inputs and Outputs	431

Figure A1-14. Define Activities: Inputs and Outputs	432
Figure A1-15. Sequence Activities: Inputs and Outputs.....	432
Figure A1-16. Estimate Activity Resources: Inputs and Outputs	433
Figure A1-17. Estimate Activity Durations: Inputs and Outputs	434
Figure A1-18. Develop Schedule: Inputs and Outputs.....	435
Figure A1-19. Plan Cost Management: Inputs and Outputs	436
Figure A1-20. Estimate Costs: Inputs and Outputs.....	436
Figure A1-21. Determine Budget: Inputs and Outputs	437
Figure A1-22. Plan Quality Management: Inputs and Outputs.....	438
Figure A1-23. Plan Human Resource Management: Inputs and Outputs	438
Figure A1-24. Plan Communications Management: Inputs and Outputs	439
Figure A1-25. Plan Risk Management: Inputs and Outputs	439
Figure A1-26. Identify Risks: Inputs and Outputs.....	440
Figure A1-27. Perform Qualitative Risk Analysis: Inputs and Outputs	441
Figure A1-28. Perform Quantitative Risk Analysis: Inputs and Outputs.....	441
Figure A1-29. Plan Risk Responses: Inputs and Outputs.....	442
Figure A1-30. Plan Procurement Management: Inputs and Outputs	443
Figure A1-31. Plan Stakeholder Management: Inputs and Outputs	443
Figure A1-32. Executing Process Group	445
Figure A1-33. Direct and Manage Project Work: Inputs and Outputs.....	446
Figure A1-34. Perform Quality Assurance: Inputs and Outputs	446
Figure A1-35. Acquire Project Team: Inputs and Outputs	447

Figure A1-36. Develop Project Team: Inputs and Outputs.....	447
Figure A1-37. Manage Project Team: Inputs and Outputs.....	448
Figure A1-38. Manage Communications: Inputs and Outputs	448
Figure A1-39. Conduct Procurements: Inputs and Outputs	449
Figure A1-40. Manage Stakeholder Engagement: Inputs and Outputs	450
Figure A1-41. Monitoring and Controlling Process Group	451
Figure A1-42. Monitor and Control Project Work: Inputs and Outputs.....	452
Figure A1-43. Perform Integrated Change Control: Inputs and Outputs.....	453
Figure A1-44. Validate Scope: Inputs and Outputs.....	453
Figure A1-45. Control Scope: Inputs and Outputs	454
Figure A1-46. Control Schedule: Inputs and Outputs.....	455
Figure A1-47. Control Costs: Inputs and Outputs.....	455
Figure A1-48. Control Quality: Inputs and Outputs.....	456
Figure A1-49. Control Communications: Inputs and Outputs	457
Figure A1-50. Control Risks: Inputs and Outputs.....	457
Figure A1-51. Control Procurements: Inputs and Outputs	458
Figure A1-52. Control Stakeholder Engagement: Inputs and Outputs.....	459
Figure A1-53. Closing Process Group	460
Figure A1-54. Close Project or Phase: Inputs and Outputs	461
Figure A1-55. Close Procurements: Inputs and Outputs.....	461

Figure X1-1.	Refined Data Model	467
Table 1-1.	Comparative Overview of Project, Program, and Portfolio Management	8
Table 2-1.	Influence of Organizational Structures on Projects	22
Table 3-1.	Project Management Process Group and Knowledge Area Mapping	61
Table 4-1	Differentiation Between the Project Management Plan and Project Documents	78
Table 5-1.	Elements of the Project Charter and Project Scope Statement	124
Table 7-1.	Earned Value Calculations Summary Table	224
Table 11-1.	Definition of Impact Scales for Four Project Objectives	318
Table A1-1.	Project Management Process Group and Knowledge Area Mapping	423
Table X1-1.	Section 4 Changes	472
Table X1-2.	Section 5 Changes	473
Table X1-3.	Section 6 Changes	474
Table X1-4.	Section 7 Changes	475
Table X1-5.	Section 8 Changes	476
Table X1-6.	Section 9 Changes	477
Table X1-7.	Section 10 Changes	478
Table X1-8.	Section 11 Changes	479
Table X1-9.	Section 12 Changes	480
Table X1-10.	Section 13 Changes	481

INTRODUCTION

A Guide to the Project Management Body of Knowledge (PMBOK® Guide) – Fifth Edition provides guidelines for managing individual projects and defines project management related concepts. It also describes the project management life cycle and its related processes, as well as the project life cycle.

The *PMBOK® Guide* contains the globally recognized standard and guide for the project management profession (found in Annex A1). A standard is a formal document that describes established norms, methods, processes, and practices. As with other professions, the knowledge contained in this standard has evolved from the recognized good practices of project management practitioners who have contributed to the development of this standard.

The first two sections of the *PMBOK® Guide* provide an introduction to key concepts in the project management field. Section 3 summarizes the Process Groups and provides an overview of process interactions among the ten Knowledge Areas and five Process Groups. Sections 4 through 13 are the guide to the project management body of knowledge. These sections expand on the information in the standard by describing the inputs and outputs, as well as tools and techniques used in managing projects. Annex A1 is the standard for project management and presents the processes, inputs, and outputs that are considered to be good practice on most projects most of the time.

This section defines several key terms and the relationship among portfolio management, program management, project management and organizational project management. An overview of the *PMBOK® Guide* is found within the following sections:

1.1 Purpose of the *PMBOK® Guide*

1.2 What is a Project?

1.3 What is Project Management?

1.4 Relationships Among Portfolio Management, Program Management, Project Management, and Organizational Project Management

1.5 Relationship Between Project Management, Operations Management, and Organizational Strategy

1.6 Business Value

1.7 Role of the Project Manager

1.8 Project Management Body of Knowledge

1.1 Purpose of the *PMBOK® Guide*

The acceptance of project management as a profession indicates that the application of knowledge, processes, skills, tools, and techniques can have a significant impact on project success. The *PMBOK® Guide* identifies that subset of the project management body of knowledge that is generally recognized as good practice. “Generally recognized” means the knowledge and practices described are applicable to most projects most of the time, and there is consensus about their value and usefulness. “Good practice” means there is general agreement that the application of the knowledge, skills, tools, and techniques can enhance the chances of success over many projects. “Good practice” does not mean that the knowledge described should always be applied uniformly to all projects; the organization and/or project management team is responsible for determining what is appropriate for any given project.

The *PMBOK® Guide* also provides and promotes a common vocabulary within the project management profession for using and applying project management concepts. A common vocabulary is an essential element of a professional discipline. The *PMI Lexicon of Project Management Terms* [1]¹ provides the foundational professional vocabulary that can be consistently used by project, program, and portfolio managers and other stakeholders.

Annex A1 is a foundational reference for PMI’s project management professional development programs. Annex A1 continues to evolve along with the profession, and is therefore not all-inclusive; this standard is a guide rather than a specific methodology. One can use different methodologies and tools (e.g., agile, waterfall, PRINCE2) to implement the project management framework.

In addition to the standards that establish guidelines for project management processes, the *Project Management Institute Code of Ethics and Professional Conduct* [2] guides practitioners of the profession and describes the expectations that practitioners should hold for themselves and others. The *Project Management Institute Code of Ethics and Professional Conduct* is specific about the basic obligation of responsibility, respect, fairness, and honesty. It requires that practitioners demonstrate a commitment to ethical and professional conduct. It carries the obligation to comply with laws, regulations, and organizational and professional policies. Practitioners come from diverse backgrounds and cultures, and the *Project Management Institute Code of Ethics and Professional Conduct* applies globally. When interacting with any stakeholder, practitioners should be committed to honest, responsible, fair practices and respectful dealings. Acceptance of the code is essential for project managers, and is a requirement for the following PMI® exams:

- Certified Associate in Project Management (CAPM)®
- Project Management Professional (PMP)®
- Program Management Professional (PgMP)®
- PMI Agile Certified Practitioner (PMI-ACP)SM
- PMI Risk Management Professional (PMI-RMP)®
- PMI Scheduling Professional (PMI-SP)®

¹The numbers in brackets refer to the list of references at the end of this standard.

1.2 What is a Project?

A project is a temporary endeavor undertaken to create a unique product, service, or result. The temporary nature of projects indicates that a project has a definite beginning and end. The end is reached when the project's objectives have been achieved or when the project is terminated because its objectives will not or cannot be met, or when the need for the project no longer exists. A project may also be terminated if the client (customer, sponsor, or champion) wishes to terminate the project. Temporary does not necessarily mean the duration of the project is short. It refers to the project's engagement and its longevity. Temporary does not typically apply to the product, service, or result created by the project; most projects are undertaken to create a lasting outcome. For example, a project to build a national monument will create a result expected to last for centuries. Projects can also have social, economic, and environmental impacts that far outlive the projects themselves.

Every project creates a unique product, service, or result. The outcome of the project may be tangible or intangible. Although repetitive elements may be present in some project deliverables and activities, this repetition does not change the fundamental, unique characteristics of the project work. For example, office buildings can be constructed with the same or similar materials and by the same or different teams. However, each building project remains unique with a different location, different design, different circumstances and situations, different stakeholders, and so on.

An ongoing work effort is generally a repetitive process that follows an organization's existing procedures. In contrast, because of the unique nature of projects, there may be uncertainties or differences in the products, services, or results that the project creates. Project activities can be new to members of a project team, which may necessitate more dedicated planning than other routine work. In addition, projects are undertaken at all organizational levels. A project can involve a single individual or multiple individuals, a single organizational unit, or multiple organizational units from multiple organizations.

A project can create:

- A product that can be either a component of another item, an enhancement of an item, or an end item in itself;
- A service or a capability to perform a service (e.g., a business function that supports production or distribution);
- An improvement in the existing product or service lines (e.g., A Six Sigma project undertaken to reduce defects); or
- A result, such as an outcome or document (e.g., a research project that develops knowledge that can be used to determine whether a trend exists or a new process will benefit society).

Examples of projects include, but are not limited to:

- Developing a new product, service, or result;
- Effecting a change in the structure, processes, staffing, or style of an organization;
- Developing or acquiring a new or modified information system (hardware or software);
- Conducting a research effort whose outcome will be aptly recorded;
- Constructing a building, industrial plant, or infrastructure; or
- Implementing, improving, or enhancing existing business processes and procedures.

1.2.1. The Relationships Among Portfolios, Programs, and Projects

The relationship among portfolios, programs, and projects is such that a portfolio refers to a collection of projects, programs, subportfolios, and operations managed as a group to achieve strategic objectives. Programs are grouped within a portfolio and are comprised of subprograms, projects, or other work that are managed in a coordinated fashion in support of the portfolio. Individual projects that are either within or outside of a program are still considered part of a portfolio. Although the projects or programs within the portfolio may not necessarily be interdependent or directly related, they are linked to the organization's strategic plan by means of the organization's portfolio.

As Figure 1-1 illustrates, organizational strategies and priorities are linked and have relationships between portfolios and programs, and between programs and individual projects. Organizational planning impacts the projects by means of project prioritization based on risk, funding, and other considerations relevant to the organization's strategic plan. Organizational planning can direct the management of resources, and support for the component projects on the basis of risk categories, specific lines of business, or general types of projects, such as infrastructure and process improvement.

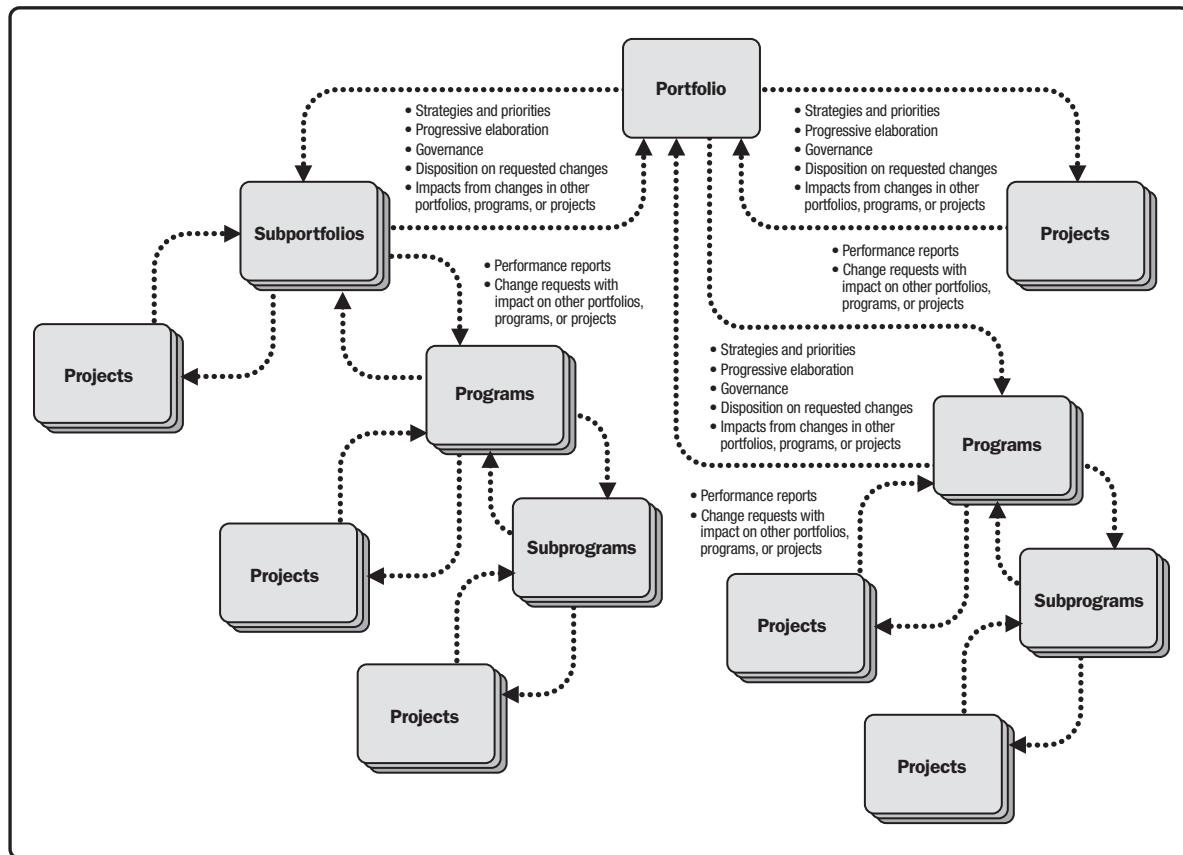

Figure 1-1. Portfolio, Program, and Project Management Interactions

1.3 What is Project Management?

Project management is the application of knowledge, skills, tools, and techniques to project activities to meet the project requirements. Project management is accomplished through the appropriate application and integration of the 47 logically grouped project management processes, which are categorized into five Process Groups. These five Process Groups are:

- Initiating,
- Planning,
- Executing,
- Monitoring and Controlling, and
- Closing.

Managing a project typically includes, but is not limited to:

- Identifying requirements;
- Addressing the various needs, concerns, and expectations of the stakeholders in planning and executing the project;
- Setting up, maintaining, and carrying out communications among stakeholders that are active, effective, and collaborative in nature;
- Managing stakeholders towards meeting project requirements and creating project deliverables;
- Balancing the competing project constraints, which include, but are not limited to:
 - Scope,
 - Quality,
 - Schedule,
 - Budget,
 - Resources, and
 - Risks.

The specific project characteristics and circumstances can influence the constraints on which the project management team needs to focus.

The relationship among these factors is such that if any one factor changes, at least one other factor is likely to be affected. For example, if the schedule is shortened, often the budget needs to be increased to add additional resources to complete the same amount of work in less time. If a budget increase is not possible, the scope or targeted quality may be reduced to deliver the project's end result in less time within the same budget amount. Project stakeholders may have differing ideas as to which factors are the most important, creating an even greater challenge. Changing the project requirements or objectives may create additional risks. The project team needs to be able to assess the situation, balance the demands, and maintain proactive communication with stakeholders in order to deliver a successful project.

Due to the potential for change, the development of the project management plan is an iterative activity and is progressively elaborated throughout the project's life cycle. Progressive elaboration involves continuously improving and detailing a plan as more detailed and specific information and more accurate estimates become available. Progressive elaboration allows a project management team to define work and manage it to a greater level of detail as the project evolves.

1.4 Relationships Among Portfolio Management, Program Management, Project Management, and Organizational Project Management

In order to understand portfolio, program, and project management, it is important to recognize the similarities and differences among these disciplines. It is also helpful to understand how they relate to organizational project management (OPM). OPM is a strategy execution framework utilizing project, program, and portfolio management as well as organizational enabling practices to consistently and predictably deliver organizational strategy producing better performance, better results, and a sustainable competitive advantage.

Portfolio, program, and project management are aligned with or driven by organizational strategies. Conversely, portfolio, program, and project management differ in the way each contributes to the achievement of strategic goals. Portfolio management aligns with organizational strategies by selecting the right programs or projects, prioritizing the work, and providing the needed resources, whereas program management harmonizes its projects and program components and controls interdependencies in order to realize specified benefits. Project management develops and implements plans to achieve a specific scope that is driven by the objectives of the program or portfolio it is subjected to and, ultimately, to organizational strategies. OPM advances organizational capability by linking project, program, and portfolio management principles and practices with organizational enablers (e.g. structural, cultural, technological, and human resource practices) to support strategic goals. An organization measures its capabilities, then plans and implements improvements towards the systematic achievement of best practices.

Table 1-1 shows the comparison of project, program, and portfolio views across several dimensions within the organization.

Table 1-1. Comparative Overview of Project, Program, and Portfolio Management

Organizational Project Management			
	Projects	Programs	Portfolios
Scope	Projects have defined objectives. Scope is progressively elaborated throughout the project life cycle.	Programs have a larger scope and provide more significant benefits.	Portfolios have an organizational scope that changes with the strategic objectives of the organization.
Change	Project managers expect change and implement processes to keep change managed and controlled.	Program managers expect change from both inside and outside the program and are prepared to manage it.	Portfolio managers continuously monitor changes in the broader internal and external environment.
Planning	Project managers progressively elaborate high-level information into detailed plans throughout the project life cycle.	Program managers develop the overall program plan and create high-level plans to guide detailed planning at the component level.	Portfolio managers create and maintain necessary processes and communication relative to the aggregate portfolio.
Management	Project managers manage the project team to meet the project objectives.	Program managers manage the program staff and the project managers; they provide vision and overall leadership.	Portfolio managers may manage or coordinate portfolio management staff, or program and project staff that may have reporting responsibilities into the aggregate portfolio.
Success	Success is measured by product and project quality, timeliness, budget compliance, and degree of customer satisfaction.	Success is measured by the degree to which the program satisfies the needs and benefits for which it was undertaken.	Success is measured in terms of the aggregate investment performance and benefit realization of the portfolio.
Monitoring	Project managers monitor and control the work of producing the products, services, or results that the project was undertaken to produce.	Program managers monitor the progress of program components to ensure the overall goals, schedules, budget, and benefits of the program will be met.	Portfolio managers monitor strategic changes and aggregate resource allocation, performance results, and risk of the portfolio.

1.4.1 Program Management

A program is defined as a group of related projects, subprograms, and program activities managed in a coordinated way to obtain benefits not available from managing them individually. Programs may include elements of related work outside the scope of the discrete projects in the program. A project may or may not be part of a program but a program will always have projects.

Program management is the application of knowledge, skills, tools, and techniques to a program in order to meet the program requirements and to obtain benefits and control not available by managing projects individually.

Projects within a program are related through the common outcome or collective capability. If the relationship between projects is only that of a shared client, seller, technology, or resource, the effort should be managed as a portfolio of projects rather than as a program.

Program management focuses on the project interdependencies and helps to determine the optimal approach for managing them. Actions related to these interdependencies may include:

- Resolving resource constraints and/or conflicts that affect multiple projects within the program,
- Aligning organizational/strategic direction that affects project and program goals and objectives, and
- Resolving issues and change management within a shared governance structure.

An example of a program is a new communications satellite system with projects for design of the satellite and the ground stations, the construction of each, the integration of the system, and the launch of the satellite.

1.4.2 Portfolio Management

A portfolio refers to projects, programs, subportfolios, and operations managed as a group to achieve strategic objectives. The projects or programs of the portfolio may not necessarily be interdependent or directly related. For example, an infrastructure firm that has the strategic objective of “maximizing the return on its investments” may put together a portfolio that includes a mix of projects in oil and gas, power, water, roads, rail, and airports. From this mix, the firm may choose to manage related projects as one program. All of the power projects may be grouped together as a power program. Similarly, all of the water projects may be grouped together as a water program. Thus, the power program and the water program become integral components of the enterprise portfolio of the infrastructure firm.

Portfolio management refers to the centralized management of one or more portfolios to achieve strategic objectives. Portfolio management focuses on ensuring that projects and programs are reviewed to prioritize resource allocation, and that the management of the portfolio is consistent with and aligned to organizational strategies.

1.4.3 Projects and Strategic Planning

Projects are often utilized as a means of directly or indirectly achieving objectives within an organization's strategic plan. Projects are typically authorized as a result of one or more of the following strategic considerations:

- Market demand (e.g., a car company authorizing a project to build more fuel-efficient cars in response to gasoline shortages);
- Strategic opportunity/business need (e.g., a training company authorizing a project to create a new course to increase its revenues);
- Social need (e.g., a nongovernmental organization in a developing country authorizing a project to provide potable water systems, latrines, and sanitation education to communities suffering from high rates of infectious diseases);
- Environmental consideration (e.g., a public company authorizing a project to create a new service for electric car sharing to reduce pollution);
- Customer request (e.g., an electric utility authorizing a project to build a new substation to serve a new industrial park);
- Technological advance (e.g., an electronics firm authorizing a new project to develop a faster, cheaper, and smaller laptop based on advances in computer memory and electronics technology); and
- Legal requirement (e.g., a chemical manufacturer authorizing a project to establish guidelines for proper handling of a new toxic material).

1.4.4 Project Management Office

A project management office (PMO) is a management structure that standardizes the project-related governance processes and facilitates the sharing of resources, methodologies, tools, and techniques. The responsibilities of a PMO can range from providing project management support functions to actually being responsible for the direct management of one or more projects.

There are several types of PMO structures in organizations, each varying in the degree of control and influence they have on projects within the organization, such as:

- **Supportive.** Supportive PMOs provide a consultative role to projects by supplying templates, best practices, training, access to information and lessons learned from other projects. This type of PMO serves as a project repository. The degree of control provided by the PMO is low.
- **Controlling.** Controlling PMOs provide support and require compliance through various means. Compliance may involve adopting project management frameworks or methodologies, using specific templates, forms and tools, or conformance to governance. The degree of control provided by the PMO is moderate.
- **Directive.** Directive PMOs take control of the projects by directly managing the projects. The degree of control provided by the PMO is high.

The PMO integrates data and information from corporate strategic projects and evaluates how higher level strategic objectives are being fulfilled. The PMO is the natural liaison between the organization's portfolios, programs, projects, and the corporate measurement systems (e.g. balanced scorecard).

The projects supported or administered by the PMO may not be related, other than by being managed together. The specific form, function, and structure of a PMO are dependent upon the needs of the organization that it supports.

A PMO may have the authority to act as an integral stakeholder and a key decision maker throughout the life of each project, to make recommendations, or to terminate projects or take other actions, as required, to remain aligned with the business objectives. In addition, the PMO may be involved in the selection, management, and deployment of shared or dedicated project resources.

A primary function of a PMO is to support project managers in a variety of ways which may include, but are not limited to:

- Managing shared resources across all projects administered by the PMO;
- Identifying and developing project management methodology, best practices, and standards;
- Coaching, mentoring, training, and oversight;
- Monitoring compliance with project management standards, policies, procedures, and templates by means of project audits;
- Developing and managing project policies, procedures, templates, and other shared documentation (organizational process assets); and
- Coordinating communication across projects.

Project managers and PMOs pursue different objectives and, as such, are driven by different requirements. All of these efforts are aligned with the strategic needs of the organization. Differences between the role of project managers and a PMO may include the following:

- The project manager focuses on the specified project objectives, while the PMO manages major program scope changes, which may be seen as potential opportunities to better achieve business objectives.
- The project manager controls the assigned project resources to best meet project objectives, while the PMO optimizes the use of shared organizational resources across all projects.
- The project manager manages the constraints (scope, schedule, cost, quality, etc.) of the individual projects, while the PMO manages the methodologies, standards, overall risks/opportunities, metrics, and interdependencies among projects at the enterprise level.

1.5 Relationship Between Project Management, Operations Management, and Organizational Strategy

Operations management is responsible for overseeing, directing, and controlling business operations. Operations evolve to support the day-to-day business, and are necessary to achieve strategic and tactical goals of the business. Examples include: production operations, manufacturing operations, accounting operations, software support, and maintenance.

Though temporary in nature, projects can help achieve the organizational goals when they are aligned with the organization's strategy. Organizations sometimes change their operations, products, or systems by creating strategic business initiatives that are developed and implemented through projects. Projects require project management activities and skill sets, while operations require business process management, operations management activities, and skill sets.

1.5.1 Operations and Project Management

Changes in business operations may be the focus of a dedicated project—especially if there are substantial changes to business operations as a result of a new product or service delivery. Ongoing operations are outside of the scope of a project; however, there are intersecting points where the two areas cross.

Projects can intersect with operations at various points during the product life cycle, such as:

- At each closeout phase;
- When developing a new product, upgrading a product, or expanding outputs;
- While improving operations or the product development process; or
- Until the end of the product life cycle.

At each point, deliverables and knowledge are transferred between the project and operations for implementation of the delivered work. This implementation occurs through a transfer of project resources to operations toward the end of the project, or through a transfer of operational resources to the project at the start.

Operations are ongoing endeavors that produce repetitive outputs, with resources assigned to do basically the same set of tasks according to the standards institutionalized in a product life cycle. Unlike the ongoing nature of operations, projects are temporary endeavors.

1.5.1.1 Operations Management

Operations management is a subject area that is outside the scope of formal project management as described in this standard.

Operations management is an area of management concerned with ongoing production of goods and/or services. It involves ensuring that business operations continue efficiently by using the optimum resources needed and meeting customer demands. It is concerned with managing processes that transform inputs (e.g., materials, components, energy, and labor) into outputs (e.g., products, goods, and/or services).

1.5.1.2 Operational Stakeholders in Project Management

While operations management is different from project management (see 1.5.1.1), the needs of stakeholders who perform and conduct business operations are important considerations in projects that will affect their future work and endeavors. Project managers who consider and appropriately include operational stakeholders in all phases of projects, gain insight and avoid unnecessary issues that often arise when their input is overlooked.

Operational stakeholders should be engaged and their needs identified as part of the stakeholder register, and their influence (positive or negative) should be addressed as part of the risk management plan.

The following list includes examples of operational stakeholders (depending upon the business):

- Plant operators,
- Manufacturing line supervisors,
- Help desk staff,
- Production system support analysts,
- Customer service representative,
- Salespersons,
- Maintenance workers,
- Telephone sales personnel,
- Call center personnel,
- Retail workers,
- Line managers, and
- Training officers.

1.5.2 Organizations and Project Management

Organizations use governance to establish strategic direction and performance parameters. The strategic direction provides the purpose, expectations, goals, and actions necessary to guide business pursuit and is aligned with business objectives. Project management activities should be aligned with top-level business direction, and if there is a change, then project objectives need to be realigned. In a project environment, changes to project objectives affect project efficiency and success. When the business alignment for a project is constant, the chance for project success greatly increases because the project remains aligned with the strategic direction of the organization. Should something change, projects should change accordingly.

1.5.2.1 Project-Based Organizations

Project-based organizations (PBOs) refer to various organizational forms that create temporary systems for carrying out their work. PBOs can be created by different types of organizations (i.e., functional, matrix, or projectized (see 2.1.3)). The use of PBOs may diminish the hierarchy and bureaucracy inside the organizations as the success of the work is measured by the final result rather than by position or politics.

PBOs conduct the majority of their work as projects and/or provide project rather than functional approaches. PBOs can refer to either entire firms (as in telecommunications, oil and gas, construction, consultancy, and professional services) multi-firm consortia, or networks; it is also possible that some large project-based organizations have functional support areas or that the PBO is nested within subsidiaries or divisions of larger corporations.

1.5.2.2 The Link Between Project Management and Organizational Governance

Projects (and programs) are undertaken to achieve strategic business outcomes, for which many organizations now adopt formal organizational governance processes and procedures. Organizational governance criteria can impose constraints on projects—particularly if the project delivers a service which will be subject to strict organizational governance.

Because project success may be judged on the basis of how well the resultant product or service supports organizational governance, it is important for the project manager to be knowledgeable about corporate/organizational governance policies and procedures pertaining to the subject matter of the product or service (e.g., if an organization has adopted policies in support of sustainability practices and the project involves construction of a new office building, the project manager should be aware of sustainability requirements related to building construction.)

1.5.2.3 The Relationship Between Project Management and Organizational Strategy

Organizational strategy should provide guidance and direction to project management—especially when one considers that projects exist to support organizational strategies. Often it is the project sponsor or the portfolio or program manager who identifies alignment or potential conflicts between organizational strategies and project goals and then communicates these to the project manager. If the goals of a project are in conflict with an established organizational strategy, it is incumbent upon the project manager to document and identify such conflicts as early as possible in the project. At times, the development of an organizational strategy could be the goal of a project rather than a guiding principle. In such a case, it is important for the project to specifically define what constitutes an appropriate organizational strategy that will sustain the organization.

1.6 Business Value

Business value is a concept that is unique to each organization. Business value is defined as the entire value of the business; the total sum of all tangible and intangible elements. Examples of tangible elements include monetary assets, fixtures, stockholder equity, and utility. Examples of intangible elements include good will, brand recognition, public benefit, and trademarks. Depending on the organization, business value scope can be short-, medium-, or long-term. Value may be created through the effective management of ongoing operations. However, through the effective use of portfolio, program, and project management, organizations will possess the ability to employ reliable, established processes to meet strategic objectives and obtain greater business value from their project investments. While not all organizations are business driven, all organizations conduct business-related activities. Whether an organization is a government agency or a nonprofit organization, all organizations focus on attaining business value for their activities.

Successful business value realization begins with comprehensive strategic planning and management. Organizational strategy can be expressed through the organization's mission and vision, including orientation to markets, competition, and other environmental factors. Effective organizational strategy provides defined directions for development and growth, in addition to performance metrics for success. In order to bridge the gap between organizational strategy and successful business value realization, the use of portfolio, program, and project management techniques is essential.

Portfolio management aligns components (projects, programs, or operations) to the organizational strategy, organized into portfolios or subportfolios to optimize project or program objectives, dependencies, costs, timelines, benefits, resources, and risks. This allows organizations to have an overall view of how the strategic goals are reflected in the portfolio, institute appropriate governance management, and authorize human, financial, or material resources to be allocated based on expected performance and benefits.

Using program management, organizations have the ability to align multiple projects for optimized or integrated costs, schedule, effort, and benefits. Program management focuses on project interdependencies and helps to determine the optimal approach for managing and realizing the desired benefits.

With project management, organizations have the ability to apply knowledge, processes, skills, and tools and techniques that enhance the likelihood of success over a wide range of projects. Project management focuses on the successful delivery of products, services, or results. Within programs and portfolios, projects are a means of achieving organizational strategy and objectives.

Organizations can further facilitate the alignment of these portfolio, program, and project management activities by strengthening organizational enablers such as structural, cultural, technological, and human resource practices. By continuously conducting portfolio strategic alignment and optimization, performing business impact analyses, and developing robust organizational enablers, organizations can achieve successful transitions within the portfolio, program, and project domains and attain effective investment management and business value realization.

1.7 Role of the Project Manager

The project manager is the person assigned by the performing organization to lead the team that is responsible for achieving the project objectives. The role of a project manager is distinct from a functional manager or operations manager. Typically the functional manager is focused on providing management oversight for a functional or a business unit, and operations managers are responsible for ensuring that business operations are efficient.

Depending on the organizational structure, a project manager may report to a functional manager. In other cases, a project manager may be one of several project managers who report to a program or portfolio manager who is ultimately responsible for enterprise-wide projects. In this type of structure, the project manager works closely with the program or portfolio manager to achieve the project objectives and to ensure the project management plan aligns with the overarching program plan. The project manager also works closely and in collaboration with other roles, such as a business analyst, quality assurance manager, and subject matter experts.

1.7.1 Responsibilities and Competencies of the Project Manager

In general, project managers have the responsibility to satisfy the needs: task needs, team needs, and individual needs. As project management is a critical strategic discipline, the project manager becomes the link between the strategy and the team. Projects are essential to the growth and survival of organizations. Projects create value in the form of improved business processes, are indispensable in the development of new products and services, and make it easier for companies to respond to changes in the environment, competition, and the marketplace. The project manager's role therefore becomes increasingly strategic. However, understanding and applying the knowledge, tools, and techniques that are recognized as good practice are not sufficient for effective project management. In addition to any area-specific skills and general management proficiencies required for the project, effective project management requires that the project manager possess the following competencies:

- **Knowledge**—Refers to what the project manager knows about project management.
- **Performance**—Refers to what the project manager is able to do or accomplish while applying his or her project management knowledge.
- **Personal**—Refers to how the project manager behaves when performing the project or related activity. Personal effectiveness encompasses attitudes, core personality characteristics, and leadership, which provides the ability to guide the project team while achieving project objectives and balancing the project constraints.

1.7.2 Interpersonal Skills of a Project Manager

Project managers accomplish work through the project team and other stakeholders. Effective project managers require a balance of ethical, interpersonal, and conceptual skills that help them analyze situations and interact appropriately. Appendix X3 on Interpersonal Skills describes important interpersonal skills, such as:

- Leadership,
- Team building,
- Motivation,
- Communication,
- Influencing,
- Decision making,
- Political and cultural awareness,
- Negotiation,
- Trust building,
- Conflict management, and
- Coaching.

1.8 Project Management Body of Knowledge

The *PMBOK® Guide* contains the standard for managing most projects most of the time across many types of industries. The standard, included in Annex A1, describes the project management processes used to manage a project toward a more successful outcome.

This standard is unique to the project management field and has interrelationships to other project management disciplines such as program management and portfolio management.

Project management standards do not address all details of every topic. This standard is limited to individual projects and the project management processes that are generally recognized as good practice. Other standards may be consulted for additional information on the broader context in which projects are accomplished, such as:

- *The Standard for Program Management* [3] addresses the management of programs,
- *The Standard for Portfolio Management* [4] addresses the management of portfolios,
- *Organizational Project Management Maturity Model (OPM3®)* [5] examines an enterprise's project management process capabilities.

2

ORGANIZATIONAL INFLUENCES AND PROJECT LIFE CYCLE

Projects and project management take place in an environment that is broader than that of the project itself. Understanding this broader context helps ensure that work is carried out in alignment with the organization's goals and managed in accordance with the organization's established practices. This section describes how organizational influences affect the methods used for staffing, managing, and executing the project. It discusses the influence of stakeholders on the project and its governance, the project team's structure and membership, and different approaches to the phasing and relationship of activities within the project's life cycle. The following major sections are addressed:

2.1 Organizational Influences on Project Management

2.2 Project Stakeholders and Governance

2.3 Project Team

2.4 Project Life Cycle

2.1 Organizational Influences on Project Management

An organization's culture, style, and structure influence how its projects are performed. The organization's level of project management maturity and its project management systems can also influence the project. When a project involves external entities such as those that are part of a joint venture or partnering agreement, the project will be influenced by more than one organization. The following sections describe organizational characteristics, factors, and assets within an enterprise that are likely to influence the project.

2.1.1 Organizational Cultures and Styles

Organizations are systematic arrangements of entities (persons and/or departments) aimed at accomplishing a purpose, which may involve undertaking projects. An organization's culture and style affect how it conducts projects. Cultures and styles are group phenomena known as cultural norms, which develop over time. The norms include established approaches to initiating and planning projects, the means considered acceptable for getting the work done, and recognized authorities who make or influence decisions.

Organizational culture is shaped by the common experiences of members of the organization and most organizations have developed unique cultures over time by practice and common usage. Common experiences include, but are not limited to:

- Shared visions, mission, values, beliefs, and expectations;
- Regulations, policies, methods, and procedures;
- Motivation and reward systems;
- Risk tolerance;
- View of leadership, hierarchy, and authority relationships;
- Code of conduct, work ethic, and work hours; and
- Operating environments.

The organization's culture is an enterprise environmental factor, as described in Section 2.1.5. Cultures and styles are learned and shared and may have a strong influence on a project's ability to meet its objectives. A project manager should therefore understand the different organizational styles and cultures that may affect a project. The project manager needs to know which individuals in the organization are the decision makers or influencers and work with them to increase the probability of project success.

In light of globalization, understanding the impact of cultural influences is critical in projects involving diverse organizations and locations around the world. Culture becomes a critical factor in defining project success, and multi-cultural competence becomes critical for the project manager.

2.1.2 Organizational Communications

Project management success in an organization is highly dependent on an effective organizational communication style, especially in the face of globalization of the project management profession. Organizational communications capabilities have great influence on how projects are conducted. As a consequence, project managers in distant locations are able to more effectively communicate with all relevant stakeholders within the organizational structure to facilitate decision making. Stakeholders and project team members can also use electronic communications (including e-mail, texting, instant messaging, social media, video and web conferencing, and other forms of electronic media) to communicate with the project manager formally or informally.

2.1.3 Organizational Structures

Organizational structure is an enterprise environmental factor, which can affect the availability of resources and influence how projects are conducted (see also Section 2.1.5). Organizational structures range from functional to projectized, with a variety of matrix structures in between. Table 2-1 shows key project-related characteristics of the major types of organizational structures.

Table 2-1. Influence of Organizational Structures on Projects

Project Characteristics / Organization Structure	Functional	Matrix			Projectized
		Weak Matrix	Balanced Matrix	Strong Matrix	
Project Manager's Authority	Little or None	Low	Low to Moderate	Moderate to High	High to Almost Total
Resource Availability	Little or None	Low	Low to Moderate	Moderate to High	High to Almost Total
Who manages the project budget	Functional Manager	Functional Manager	Mixed	Project Manager	Project Manager
Project Manager's Role	Part-time	Part-time	Full-time	Full-time	Full-time
Project Management Administrative Staff	Part-time	Part-time	Part-time	Full-time	Full-time

The classic functional organization, shown in Figure 2-1, is a hierarchy where each employee has one clear superior. Staff members are grouped by specialty, such as production, marketing, engineering, and accounting at the top level. Specialties may be further subdivided into focused functional units, such as mechanical and electrical engineering. Each department in a functional organization will do its project work independently of other departments.

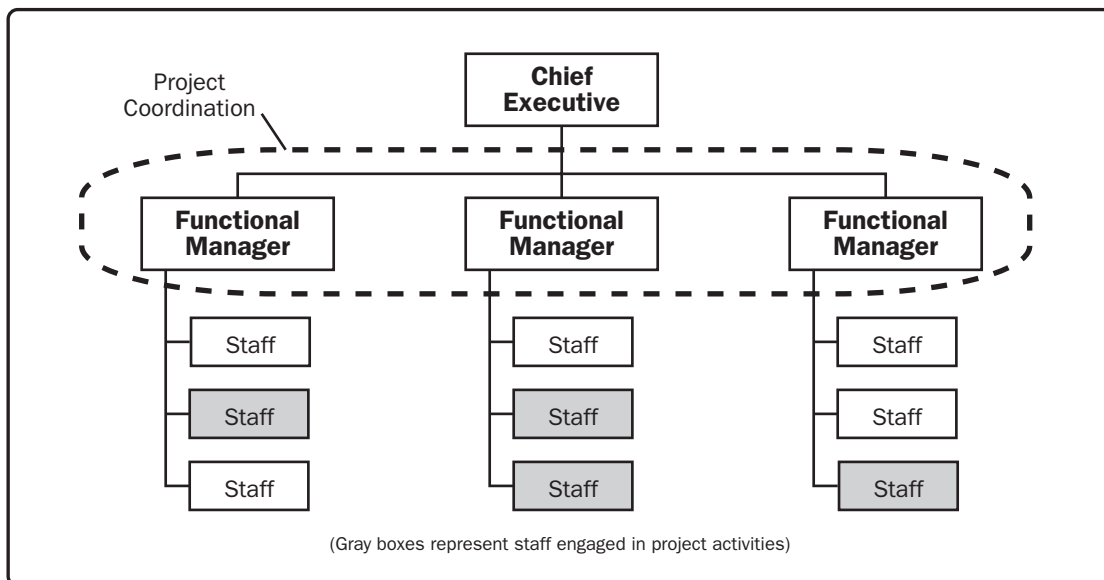

Figure 2-1. Functional Organization

Matrix organizations, as shown in Figures 2-2 through 2-4, reflect a blend of functional and projectized characteristics. Matrix organizations can be classified as weak, balanced, or strong depending on the relative level of power and influence between functional and project managers. Weak matrix organizations maintain many of the characteristics of a functional organization, and the role of the project manager is more of a coordinator or expeditor. A project expeditor works as staff assistant and communications coordinator. The expeditor cannot personally make or enforce decisions. Project coordinators have power to make some decisions, have some authority, and report to a higher-level manager. Strong matrix organizations have many of the characteristics of the projectized organization, and have full-time project managers with considerable authority and full-time project administrative staff. While the balanced matrix organization recognizes the need for a project manager, it does not provide the project manager with the full authority over the project and project funding. Table 2-1 provides additional details of the various matrix organizational structures.

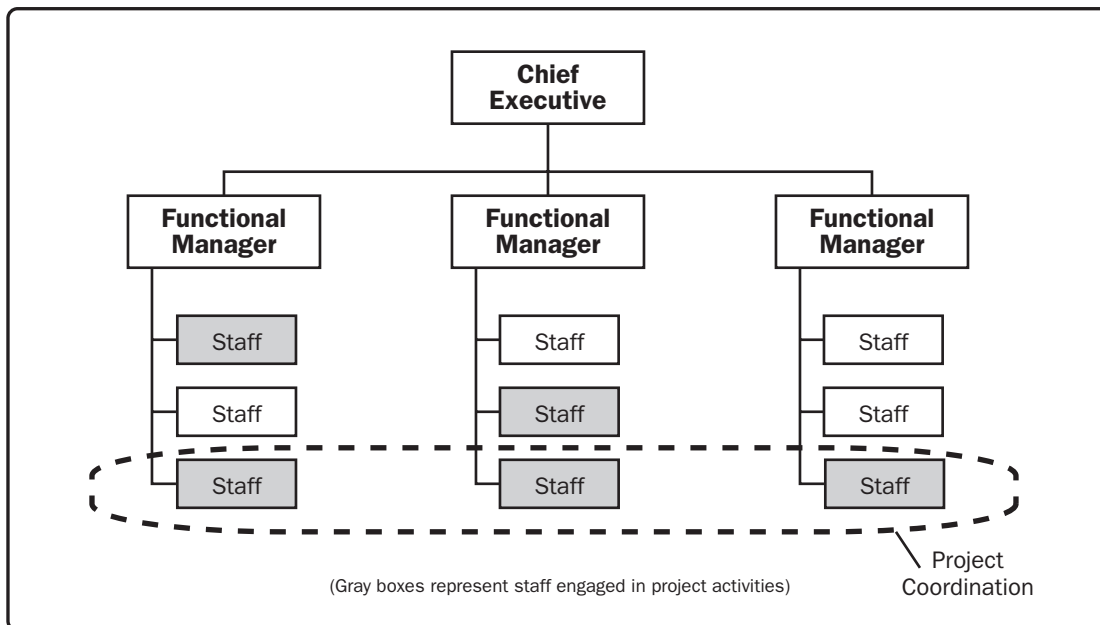

Figure 2-2. Weak Matrix Organization

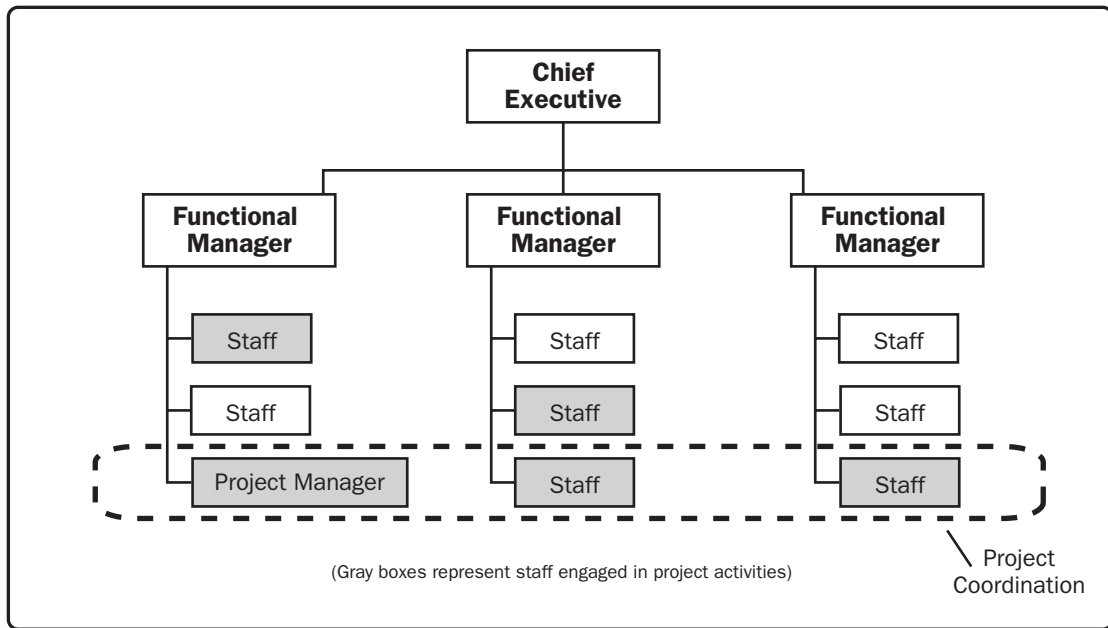

Figure 2-3. Balanced Matrix Organization

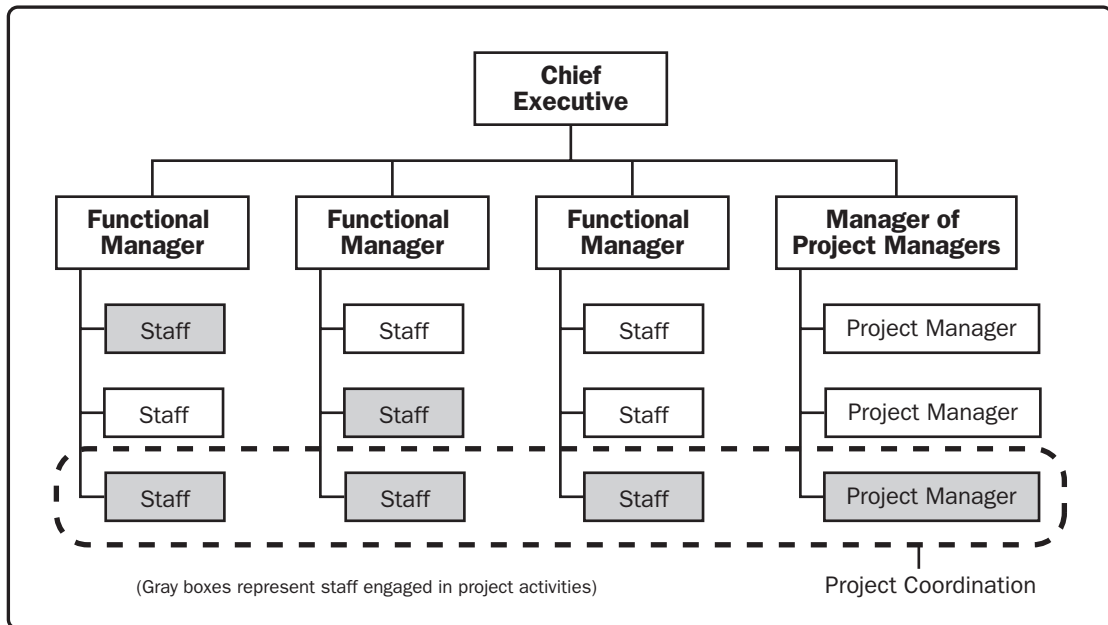

Figure 2-4. Strong Matrix Organization

At the opposite end of the spectrum to the functional organization is the projectized organization, shown in Figure 2-5. In a projectized organization, team members are often colocated. Most of the organization's resources are involved in project work, and project managers have a great deal of independence and authority. Virtual collaboration techniques are often used to accomplish the benefits of colocated teams. Projectized organizations often have organizational units called departments, but they can either report directly to the project manager or provide support services to the various projects.

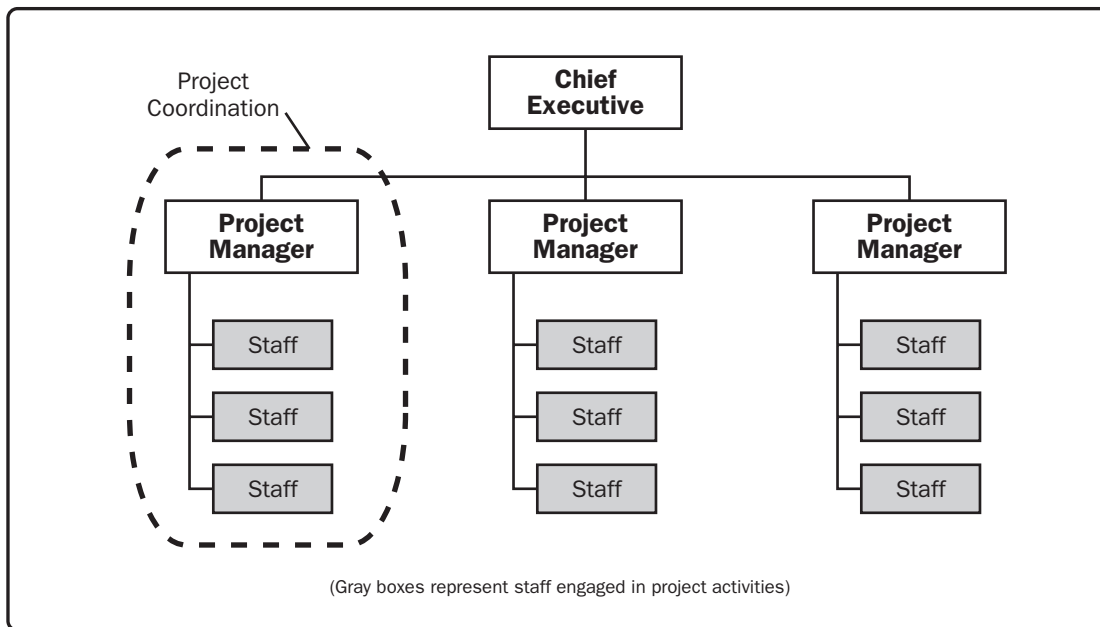

Figure 2-5. Projectized Organization

Many organizations involve all these structures at various levels, often referred to as a composite organization, as shown in Figure 2-6. For example, even a fundamentally functional organization may create a special project team to handle a critical project. Such a team may have many of the characteristics of a project team in a projectized organization. The team may include full-time staff from different functional departments, may develop its own set of operating procedures, and may even operate outside of the standard, formalized reporting structure during the project. Also, an organization may manage most of its projects in a strong matrix, but allow small projects to be managed by functional departments.

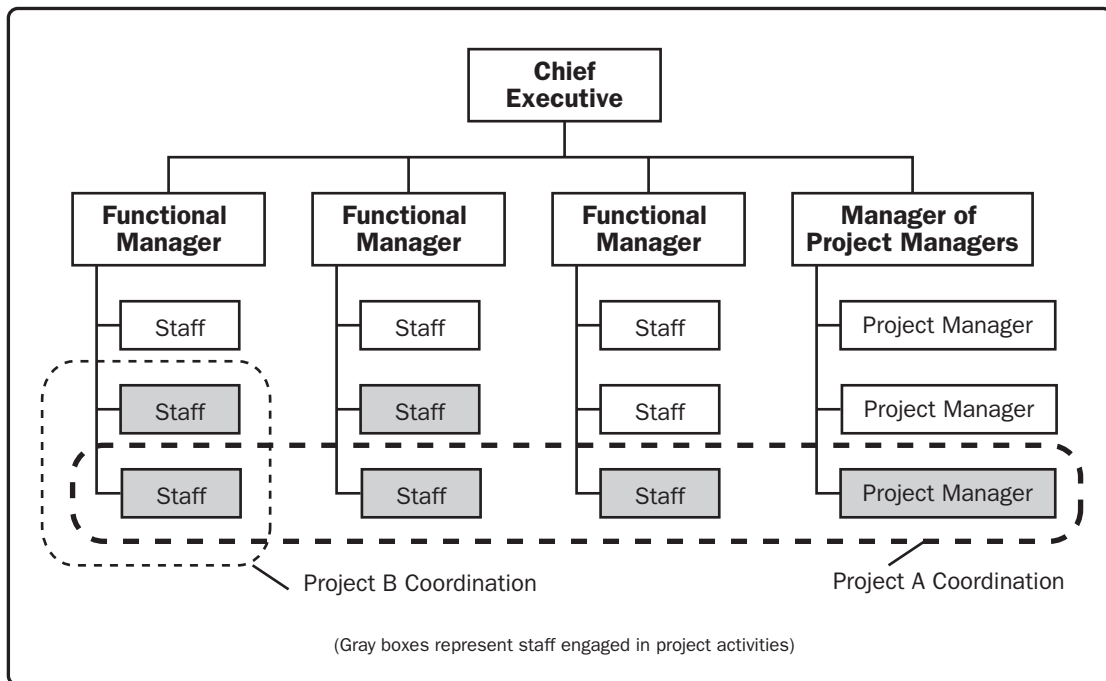

Figure 2-6. Composite Organization

Many organizational structures include strategic, middle management, and operational levels. The project manager may interact with all three levels depending on factors such as:

- Strategic importance of the project,
- Capacity of stakeholders to exert influence on the project,
- Degree of project management maturity,
- Project management systems, and
- Organizational communications.

This interaction determines project characteristics such as:

- Project manager's level of authority,
- Resource availability and management,
- Entity controlling the project budget,
- Project manager's role, and
- Project team composition.

2.1.4 Organizational Process Assets

Organizational process assets are the plans, processes, policies, procedures, and knowledge bases specific to and used by the performing organization. They include any artifact, practice, or knowledge from any or all of the organizations involved in the project that can be used to perform or govern the project. These process assets include formal and informal plans, processes, policies, procedures, and knowledge bases, specific to and used by the performing organization. The process assets also include the organization's knowledge bases such as lessons learned and historical information. Organizational process assets may include completed schedules, risk data, and earned value data. Organizational process assets are inputs to most planning processes. Throughout the project, the project team members may update and add to the organizational process assets as necessary. Organizational process assets may be grouped into two categories: (1) processes and procedures, and (2) corporate knowledge base.

2.1.4.1 Processes and Procedures

The organization's processes and procedures for conducting project work include, but are not limited to:

- *Initiating and Planning:*
 - Guidelines and criteria for tailoring the organization's set of standard processes and procedures to satisfy the specific needs of the project;
 - Specific organizational standards such as policies (e.g., human resources policies, health and safety policies, ethics policies, and project management policies), product and project life cycles, and quality policies and procedures (e.g., process audits, improvement targets, checklists, and standardized process definitions for use in the organization); and
 - Templates (e.g., risk register, work breakdown structure, project schedule network diagram, and contract templates).
- *Executing, Monitoring and Controlling:*
 - Change control procedures, including the steps by which performing organization standards, policies, plans, and procedures or any project documents will be modified, and how any changes will be approved and validated;
 - Financial controls procedures (e.g., time reporting, required expenditure and disbursement reviews, accounting codes, and standard contract provisions);
 - Issue and defect management procedures defining issue and defect controls, issue and defect identification and resolution, and action item tracking;

- Organizational communication requirements (e.g., specific communication technology available, authorized communication media, record retention policies, and security requirements);
 - Procedures for prioritizing, approving, and issuing work authorizations;
 - Risk control procedures, including risk categories, risk statement templates, probability and impact definitions, and probability and impact matrix; and
 - Standardized guidelines, work instructions, proposal evaluation criteria, and performance measurement criteria.
- *Closing:*
 - Project closure guidelines or requirements (e.g., lessons learned, final project audits, project evaluations, product validations, and acceptance criteria).

2.1.4.2 Corporate Knowledge Base

The organizational knowledge base for storing and retrieving information includes, but is not limited to:

- Configuration management knowledge bases containing the versions and baselines of all performing organization standards, policies, procedures, and any project documents;
- Financial databases containing information such as labor hours, incurred costs, budgets, and any project cost overruns;
- Historical information and lessons learned knowledge bases (e.g., project records and documents, all project closure information and documentation, information regarding both the results of previous project selection decisions and previous project performance information, and information from risk management activities);
- Issue and defect management databases containing issue and defect status, control information, issue and defect resolution, and action item results;
- Process measurement databases used to collect and make available measurement data on processes and products; and
- Project files from previous projects (e.g., scope, cost, schedule, and performance measurement baselines, project calendars, project schedule network diagrams, risk registers, planned response actions, and defined risk impact).

2.1.5 Enterprise Environmental Factors

Enterprise environmental factors refer to conditions, not under the control of the project team, that influence, constrain, or direct the project. Enterprise environmental factors are considered inputs to most planning processes, may enhance or constrain project management options, and may have a positive or negative influence on the outcome.

Enterprise environmental factors vary widely in type or nature. Enterprise environmental factors include, but are not limited to:

- Organizational culture, structure, and governance;
- Geographic distribution of facilities and resources;
- Government or industry standards (e.g., regulatory agency regulations, codes of conduct, product standards, quality standards, and workmanship standards);
- Infrastructure (e.g., existing facilities and capital equipment);
- Existing human resources (e.g., skills, disciplines, and knowledge, such as design, development, legal, contracting, and purchasing);
- Personnel administration (e.g., staffing and retention guidelines, employee performance reviews and training records, reward and overtime policy, and time tracking);
- Company work authorization systems;
- Marketplace conditions;
- Stakeholder risk tolerances;
- Political climate;
- Organization's established communications channels;
- Commercial databases (e.g., standardized cost estimating data, industry risk study information, and risk databases); and
- Project management information system (e.g., an automated tool, such as a scheduling software tool, a configuration management system, an information collection and distribution system, or web interfaces to other online automated systems).

2.2 Project Stakeholders and Governance

A stakeholder is an individual, group, or organization who may affect, be affected by, or perceive itself to be affected by a decision, activity, or outcome of a project. Stakeholders may be actively involved in the project or have interests that may be positively or negatively affected by the performance or completion of the project. Different stakeholders may have competing expectations that might create conflicts within the project. Stakeholders may also exert influence over the project, its deliverables, and the project team in order to achieve a set of outcomes that satisfy strategic business objectives or other needs. Project governance—the alignment of the project with stakeholders’ needs or objectives—is critical to the successful management of stakeholder engagement and the achievement of organizational objectives. Project governance enables organizations to consistently manage projects and maximize the value of project outcomes and align the projects with business strategy. It provides a framework in which the project manager and sponsors can make decisions that satisfy both stakeholder needs and expectations and organizational strategic objectives or address circumstances where these may not be in alignment.

2.2.1 Project Stakeholders

Stakeholders include all members of the project team as well as all interested entities that are internal or external to the organization. The project team identifies internal and external, positive and negative, and performing and advising stakeholders in order to determine the project requirements and the expectations of all parties involved. The project manager should manage the influences of these various stakeholders in relation to the project requirements to ensure a successful outcome. Figure 2-7 illustrates the relationship between the project, the project team, and various stakeholders.

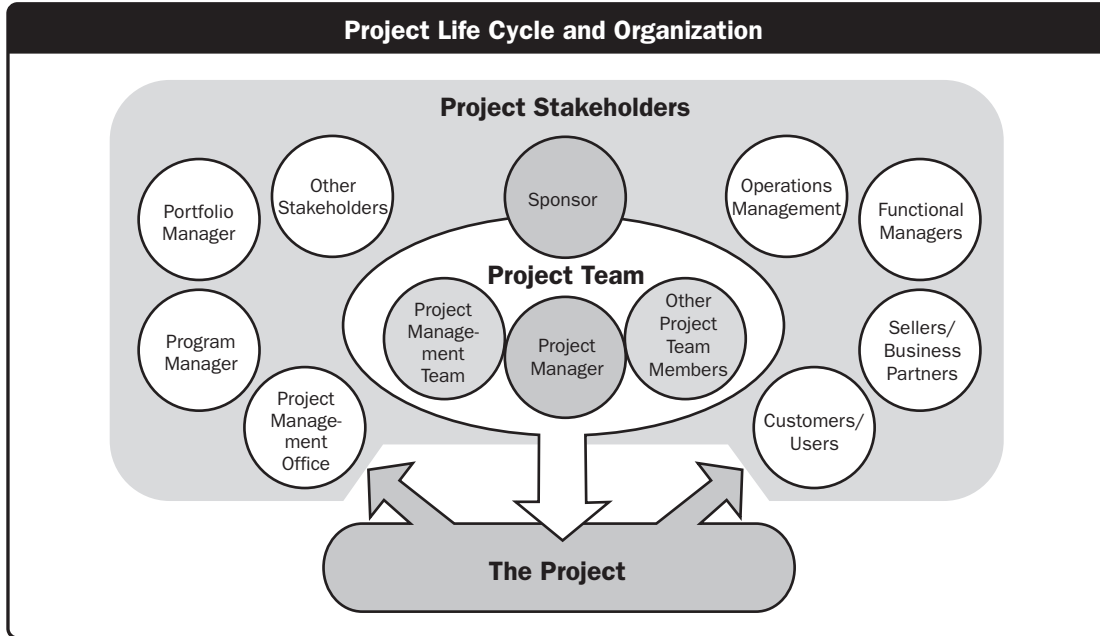

Figure 2-7. The Relationship Between Stakeholders and the Project

Stakeholders have varying levels of responsibility and authority when participating on a project. This level can change over the course of the project's life cycle. Their involvement may range from occasional contributions in surveys and focus groups to full project sponsorship which includes providing financial, political, or other support. Some stakeholders may also detract from the success of the project, either passively or actively. These stakeholders require the project manager's attention throughout the project's life cycle, as well as planning to address any issues they may raise.

Stakeholder identification is a continuous process throughout the entire project life cycle. Identifying stakeholders, understanding their relative degree of influence on a project, and balancing their demands, needs, and expectations are critical to the success of the project. Failure to do so can lead to delays, cost increases, unexpected issues, and other negative consequences including project cancellation. An example is late recognition that the legal department is a significant stakeholder, which results in delays and increased expenses due to legal requirements that are required to be met before the project can be completed or the product scope is delivered.

Just as stakeholders can positively or adversely impact a project's objectives, a project can be perceived by the stakeholders as having positive or negative results. For example, business leaders from a community who will benefit from an industrial expansion project will see positive economic benefits to the community in the form of additional jobs, supporting infrastructure, and taxes. In the case of stakeholders with positive expectations for the project, their interests are best served by making the project successful. In contrast, the interests of negatively affected stakeholders, such as nearby homeowners or small business owners who may lose property, be forced to relocate, or accept unwanted changes in the local environment, are served by impeding the project's progress. Overlooking negative stakeholder interests can result in an increased likelihood of failures, delays, or other negative consequences to the project.

An important part of a project manager's responsibility is to manage stakeholder expectations, which can be difficult because stakeholders often have very different or conflicting objectives. Part of the project manager's responsibility is to balance these interests and ensure that the project team interacts with stakeholders in a professional and cooperative manner. Project managers may involve the project's sponsor or other team members from different locations to identify and manage stakeholders that could be dispersed around the world.

The following are some examples of project stakeholders:

- **Sponsor.** A sponsor is the person or group who provides resources and support for the project and is accountable for enabling success. The sponsor may be external or internal to the project manager's organization. From initial conception through project closure, the sponsor promotes the project. This includes serving as spokesperson to higher levels of management to gather support throughout the organization and promoting the benefits the project brings. The sponsor leads the project through the initiating processes until formally authorized, and plays a significant role in the development of the initial scope and charter. For issues that are beyond the control of the project manager, the sponsor serves as an escalation path. The sponsor may also be involved in other important issues such as authorizing changes in scope, phase-end reviews, and go/no-go decisions when risks are particularly high. The sponsor also ensures a smooth transfer of the project's deliverables into the business of the requesting organization after project closure.
- **Customers and users.** Customers are the persons or organizations who will approve and manage the project's product, service, or result. Users are the persons or organizations who will use the project's product, service, or result. Customers and users may be internal or external to the performing organization and may also exist in multiple layers. For example, the customers for a new pharmaceutical product could include the doctors who prescribe it, the patients who use it and the insurers who pay for it. In some application areas, customers and users are synonymous, while in others, customers refer to the entity acquiring the project's product, and users refer to those who will directly utilize the project's product.

- **Sellers.** Sellers, also called vendors, suppliers, or contractors, are external companies that enter into a contractual agreement to provide components or services necessary for the project.
- **Business partners.** Business partners are external organizations that have a special relationship with the enterprise, sometimes attained through a certification process. Business partners provide specialized expertise or fill a specified role such as installation, customization, training, or support.
- **Organizational groups.** Organizational groups are internal stakeholders who are affected by the activities of the project team. Examples of various business elements of an organization that may be affected by the project include marketing and sales, human resources, legal, finance, operations, manufacturing, and customer service. These groups support the business environment where projects are executed, and are therefore affected by the activities of the project. As a result, there is generally a significant amount of interaction between the various business elements of an organization and the project team as they work together to achieve project goals. These groups may provide input to requirements and accept deliverables necessary for a smooth transition to production or related operations.
- **Functional managers.** Functional managers are key individuals who play a management role within an administrative or functional area of the business, such as human resources, finance, accounting, or procurement. They are assigned their own permanent staff to carry out the ongoing work, and they have a clear directive to manage all tasks within their functional area of responsibility. The functional manager may provide subject matter expertise or their function may provide services to the project.
- **Other stakeholders.** Additional stakeholders, such as procurement entities, financial institutions, government regulators, subject matter experts, consultants, and others, may have a financial interest in the project, contribute inputs to the project, or have an interest in the outcome of the project.

Project stakeholders and stakeholder engagement are further defined in Section 13 on Project Stakeholder Management.

2.2.2 Project Governance

Project governance is an oversight function that is aligned with the organization's governance model and that encompasses the project life cycle. Project governance framework provides the project manager and team with structure, processes, decision-making models and tools for managing the project, while supporting and controlling the project for successful delivery. Project governance is a critical element of any project, especially on complex and risky projects. It provides a comprehensive, consistent method of controlling the project and ensuring its success by defining and documenting and communicating reliable, repeatable project practices. It includes a framework for making project decisions; defines roles, responsibilities, and accountabilities for the success of the project; and determines the effectiveness of the project manager. A project's governance is defined by and fits within the larger context of the portfolio, program, or organization sponsoring it but is separate from organizational governance.

For project governance, the PMO may also play some decisive role. Project governance involves stakeholders as well as documented policies, procedures, and standards; responsibilities; and authorities. Examples of the elements of a project governance framework include:

- Project success and deliverable acceptance criteria;
- Process to identify, escalate, and resolve issues that arise during the project;
- Relationship among the project team, organizational groups, and external stakeholders;
- Project organization chart that identifies project roles;
- Processes and procedures for the communication of information;
- Project decision-making processes;
- Guidelines for aligning project governance and organizational strategy;
- Project life cycle approach;
- Process for stage gate or phase reviews;
- Process for review and approval for changes to budget, scope, quality, and schedule which are beyond the authority of the project manager; and
- Process to align internal stakeholders with project process requirements.

Within those constraints, as well as the additional limitations of time and budget, it is up to the project manager and the project team to determine the most appropriate method of carrying out the project. While project governance is the framework in which the project team performs, the team is still responsible for planning, executing, controlling, and closing the project. The project governance approach should be described in the project management plan. Decisions are made regarding who will be involved, the escalation procedures, what resources are necessary, and the general approach to completing the work. Another important consideration is whether more than one phase will be involved and, if so, the specific life cycle for the individual project.

2.2.3 Project Success

Since projects are temporary in nature, the success of the project should be measured in terms of completing the project within the constraints of scope, time, cost, quality, resources, and risk as approved between the project managers and senior management. To ensure realization of benefits for the undertaken project, a test period (such as soft launch in services) can be part of the total project time before handing it over to the permanent operations. Project success should be referred to the last baselines approved by the authorized stakeholders.

The project manager is responsible and accountable for setting realistic and achievable boundaries for the project and to accomplish the project within the approved baselines.

2.3 Project Team

The project team includes the project manager and the group of individuals who act together in performing the work of the project to achieve its objectives. The project team includes the project manager, project management staff, and other team members who carry out the work but who are not necessarily involved with management of the project. This team is comprised of individuals from different groups with specific subject matter knowledge or with a specific skill set to carry out the work of the project. The structure and characteristics of a project team can vary widely, but one constant is the project manager's role as the leader of the team, regardless of what authority the project manager may have over its members.

Project teams include roles such as:

- **Project management staff.** The members of the team who perform project management activities such as scheduling, budgeting, reporting and control, communications, risk management and administrative support. This role may be performed or supported by a project management office (PMO).
- **Project staff.** The members of the team who carry out the work of creating the project deliverables.
- **Supporting experts.** Supporting experts perform activities required to develop or execute the project management plan. These can include such roles as contracting, financial management, logistics, legal, safety, engineering, test, or quality control. Depending on the size of the project and level of support required, supporting experts may be assigned to work full time or may just participate on the team when their particular skills are required.
- **User or Customer Representatives.** Members of the organization who will accept the deliverables or products of the project may be assigned to act as representatives or liaisons to ensure proper coordination, advise on requirements, or validate the acceptability of the project's results.
- **Sellers.** Sellers, also called vendors, suppliers, or contractors, are external companies that enter into a contractual agreement to provide components or services necessary for the project. The project team is often assigned the responsibility to oversee the performance and acceptance of sellers' deliverables or services. If the sellers bear a large share of the risk for delivering the project's results, they may play a significant role on the project team.
- **Business partner members.** Members of business partners' organizations may be assigned as members of the project team to ensure proper coordination.
- **Business partners.** Business partners are also external companies, but they have a special relationship with the enterprise, sometimes attained through a certification process. Business partners provide specialized expertise or fill a specified role such as installation, customization, training, or support.

2.3.1 Composition of Project Teams

The composition of project teams varies based on factors such as organizational culture, scope, and location. The relationship between the project manager and the team varies depending on the authority of the project manager. In some cases, a project manager may be the team's line manager, with full authority over its members. In other cases, a project manager may have little or no direct organizational authority over the team members and may have been brought in to lead the project on a part-time basis or under contract. The following are examples of basic project team compositions:

- **Dedicated.** In a dedicated team, all or a majority of the project team members are assigned to work full-time on the project. The project team may be colocated or virtual and usually reports directly to the project manager. This is the simplest structure for a project manager, as the lines of authority are clear and team members can focus on the project's objectives.
- **Part-Time.** Some projects are established as temporary additional work, with the project manager and team members working on the project while remaining in their existing organizations and continuing to carry out their normal functions. The functional managers maintain control over the team members and the resources allocated to the project, and the project manager is likely to continue performing other management duties. Part-time team members may also be assigned to more than one project at a time.

Dedicated and part-time project team compositions may exist in any of the organizational structures. Dedicated project teams are often seen in projectized organizations, where most of the organization's resources are involved in project work and project managers have a great deal of independence and authority. Part-time project teams are common within functional organizations, and matrix organizations use both dedicated and part-time project teams. Other members who have limited involvement at various stages of a project can be thought of as part-time project team members.

Project team composition may also vary based on organizational structure. An example of this is a partnership-based project. A project may be established as a partnership, joint venture, consortium, or alliance among several organizations through contracts or agreements. In this structure, one organization takes the lead and assigns a project manager to coordinate the efforts among the partners. Partnership-based projects can offer flexibility at lower cost. These advantages may be offset by the project manager's lower degree of control over team members and the need for strong mechanisms for communication and monitoring progress. Partnership projects may be set up to exploit industrial synergies, to undertake ventures that one partner could not afford alone, or for other political and strategic reasons.

Project team composition may also vary based on the geographic location of its members. An example of this is virtual project teams. Communication technologies allow team members in different locations or countries to work as virtual teams. Virtual teams rely on collaborative tools, such as shared online workspaces and video conferences, to coordinate their activities and exchange information about the project. A virtual team can exist with any type of organizational structure and team composition. Virtual teams are often necessary for projects where resources are located onsite or offsite or both, depending on the project activities. A project manager who is leading a virtual team needs to accommodate differences in the culture, working hours, time zones, local conditions, and languages.

2.4 Project Life Cycle

A project life cycle is the series of phases that a project passes through from its initiation to its closure. The phases are generally sequential, and their names and numbers are determined by the management and control needs of the organization or organizations involved in the project, the nature of the project itself, and its area of application. The phases can be broken down by functional or partial objectives, intermediate results or deliverables, specific milestones within the overall scope of work, or financial availability. Phases are generally time bounded, with a start and ending or control point. A life cycle can be documented within a methodology. The project life cycle can be determined or shaped by the unique aspects of the organization, industry, or technology employed. While every project has a definite start and a definite end, the specific deliverables and activities that take place in between will vary widely with the project. The life cycle provides the basic framework for managing the project, regardless of the specific work involved.

Project life cycles can range along a continuum from predictive or plan-driven approaches at one end to adaptive or change-driven approaches at the other. In a predictive life cycle (Section 2.4.2.2), the product and deliverables are defined at the beginning of the project and any changes to scope are carefully managed. In an adaptive life cycle (Section 2.4.2.4), the product is developed over multiple iterations and detailed scope is defined for each iteration only as the iteration begins.

2.4.1 Characteristics of the Project Life Cycle

Projects vary in size and complexity. All projects can be mapped to the following generic life cycle structure (see Figure 2-8):

- Starting the project,
- Organizing and preparing,
- Carrying out the project work, and
- Closing the project.

This generic life cycle structure is often referred to when communicating with upper management or other entities less familiar with the details of the project. It should not be confused with the Project Management Process Groups, because the processes in a Process Group consist of activities that may be performed and recur within each phase of a project as well as for the project as a whole. The project life cycle is independent from the life cycle of the product produced by or modified by the project. However, the project should take the current life-cycle phase of the product into consideration. This high-level view can provide a common frame of reference for comparing projects—even if they are dissimilar in nature.

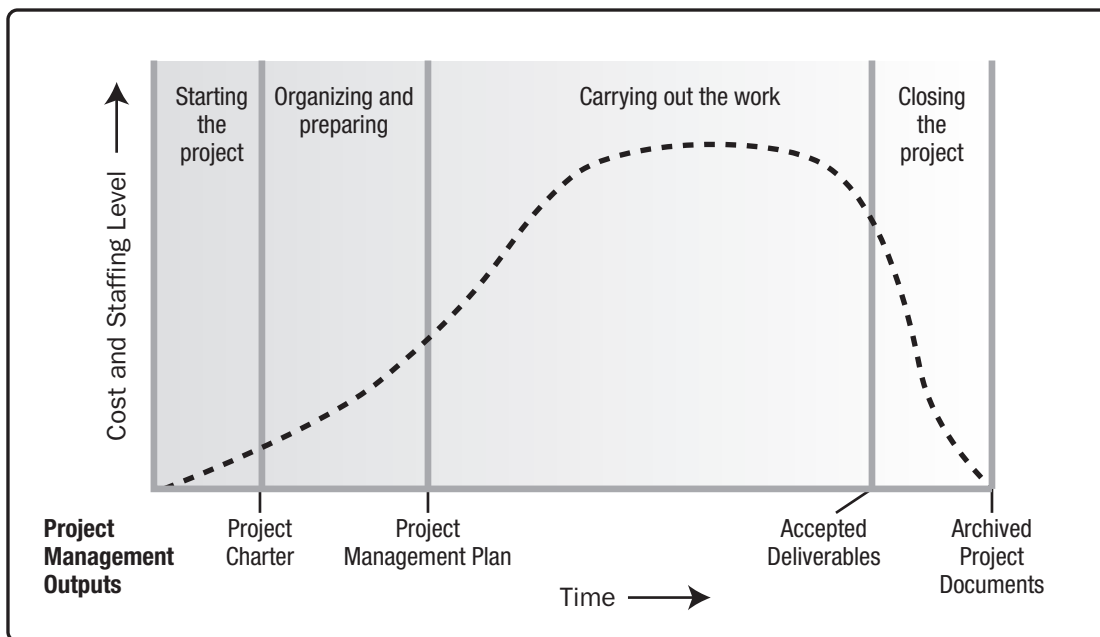

Figure 2-8. Typical Cost and Staffing Levels Across a Generic Project Life Cycle Structure

The generic life cycle structure generally displays the following characteristics:

- Cost and staffing levels are low at the start, peak as the work is carried out, and drop rapidly as the project draws to a close. Figure 2-8 illustrates this typical pattern.
- The typical cost and staffing curve above may not apply to all projects. A project may require significant expenditures to secure needed resources early in its life cycle, for instance, or be fully staffed from a point very early in its life cycle.
- Risk and uncertainty (as illustrated in Figure 2-9) are greatest at the start of the project. These factors decrease over the life of the project as decisions are reached and as deliverables are accepted.
- The ability to influence the final characteristics of the project's product, without significantly impacting cost, is highest at the start of the project and decreases as the project progresses towards completion. Figure 2-9 illustrates the idea that the cost of making changes and correcting errors typically increases substantially as the project approaches completion.

While these characteristics remain present to some extent in almost all project life cycles, they are not always present to the same degree. Adaptive life cycles, in particular, are developed with the intent of keeping stakeholder influences higher and the costs of changes lower throughout the life cycle than in predictive life cycles.

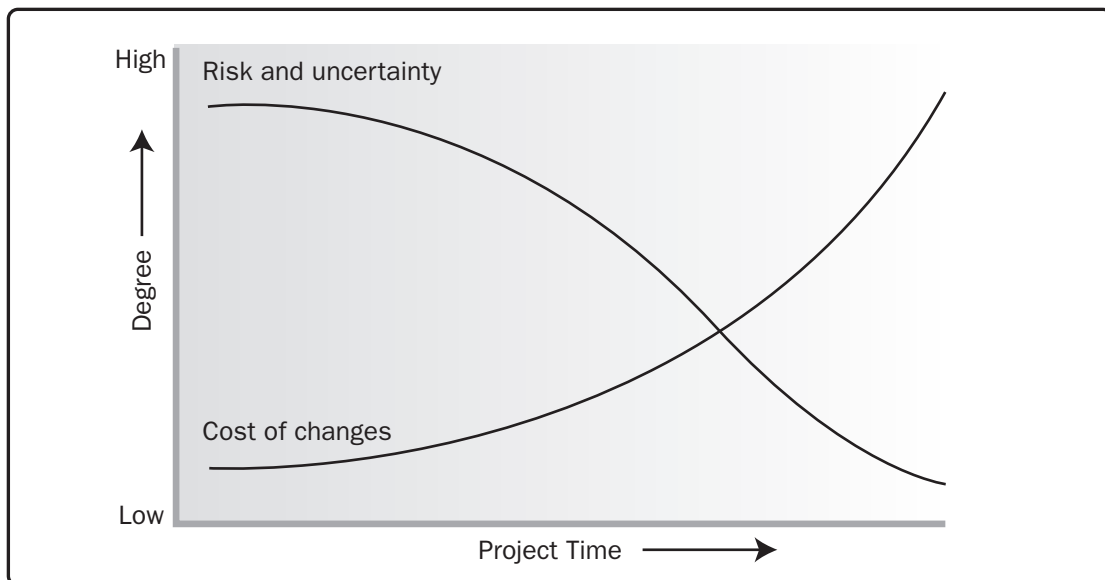

Figure 2-9. Impact of Variable Based on Project Time

Within the context of the generic life cycle structure, a project manager may determine the need for more effective control over certain deliverables or that certain deliverables are required to be completed before the project scope can be completely defined. Large and complex projects in particular may require this additional level of control. In such instances, the work carried out to complete the project's objective may benefit from being formally divided into phases.

2.4.2 Project Phases

A project may be divided into any number of phases. A project phase is a collection of logically related project activities that culminates in the completion of one or more deliverables. Project phases are used when the nature of the work to be performed is unique to a portion of the project, and are typically linked to the development of a specific major deliverable. A phase may emphasize processes from a particular Project Management Process Group, but it is likely that most or all processes will be executed in some form in each phase. Project phases typically are completed sequentially, but can overlap in some project situations. Different phases typically have a different duration or effort. The high-level nature of project phases makes them an element of the project life cycle.

The phase structure allows the project to be segmented into logical subsets for ease of management, planning, and control. The number of phases, the need for phases, and the degree of control applied depend on the size, complexity, and potential impact of the project. Regardless of the number of phases comprising a project, all phases have similar characteristics:

- The work has a distinct focus that differs from any other phase. This often involves different organizations, locations, and skill sets.
- Achieving the primary deliverable or objective of the phase requires controls or processes unique to the phase or its activities. The repetition of processes across all five Process Groups, as described in Section 3, provides an additional degree of control and defines the boundaries of the phase.
- The closure of a phase ends with some form of transfer or hand-off of the work product produced as the phase deliverable. This phase end represents a natural point to reassess the activities underway and to change or terminate the project if necessary. This point may be referred to as a stage gate, milestone, phase review, phase gate or kill point. In many cases, the closure of a phase is required to be approved in some form before it can be considered closed.

There is no single ideal structure that will apply to all projects. Although industry common practices will often lead to the use of a preferred structure, projects in the same industry—or even in the same organization—may have significant variation. Some will have only one phase, as shown in Figure 2-10. Other projects may have two or more phases.

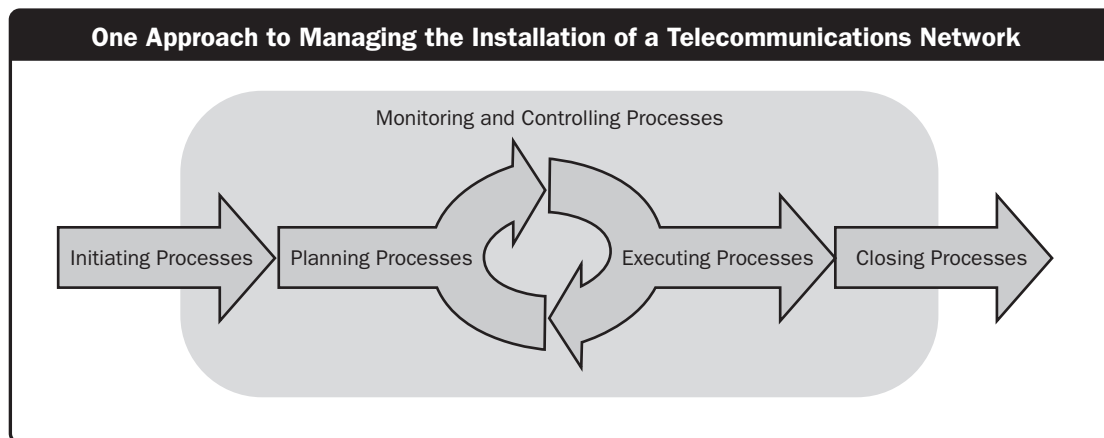

Figure 2-10. Example of a Single-Phase Project

Some organizations have established policies that standardize all projects, while others allow the project team to choose and tailor the most appropriate approach for their individual project. For instance, one organization may treat a feasibility study as routine pre-project work, another may treat it as the first phase of a project, and a third may treat the feasibility study as a separate, stand-alone project. Likewise, one project team may divide a project into two phases whereas another project team may choose to manage all the work as a single phase. Much depends on the nature of the specific project and the style of the project team or organization.

2.4.2.1 Phase-to-Phase Relationships

When projects have more than one phase, the phases are part of a generally sequential process designed to ensure proper control of the project and attain the desired product, service, or result. However, there are situations when a project might benefit from overlapping or concurrent phases.

There are two basic types of phase-to-phase relationships:

- **Sequential relationship.** In a sequential relationship, a phase starts only when the previous phase is complete. Figure 2-11 shows an example of a project with three entirely sequential phases. The step-by-step nature of this approach reduces uncertainty, but may eliminate options for reducing the overall schedule.

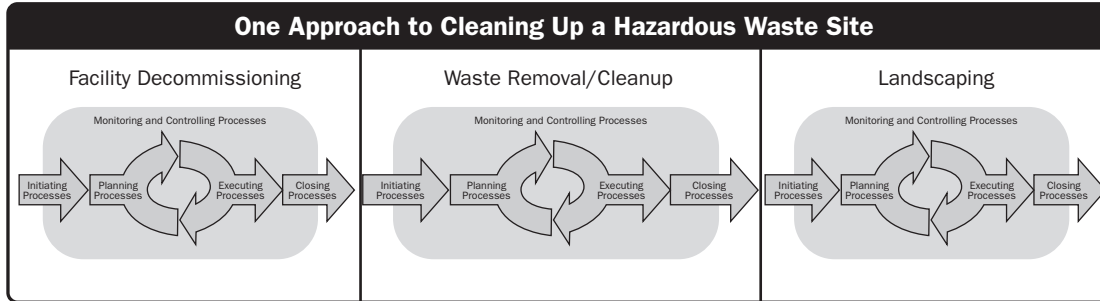

Figure 2-11. Example of a Three-Phase Project

- Overlapping relationship.** In an overlapping relationship, a phase starts prior to completion of the previous one (see Figure 2-12). This can sometimes be applied as an example of the schedule compression technique called fast tracking. Overlapping phases may require additional resources to allow work to be done in parallel, may increase risk, and can result in rework if a subsequent phase progresses before accurate information is available from the previous phase.

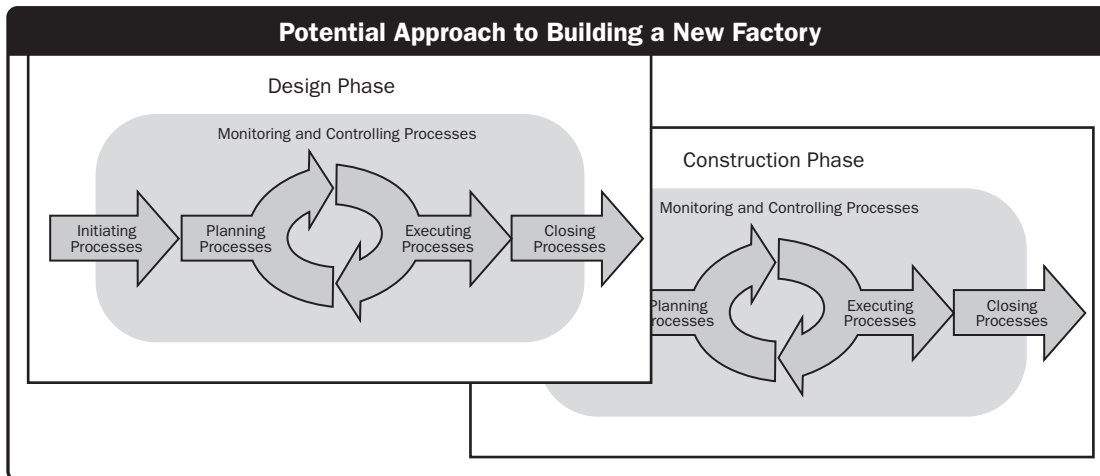

Figure 2-12. Example of a Project with Overlapping Phases

For projects with more than one phase, there may be different relationships (overlapping, sequential, parallel) between individual phases. Considerations such as level of control required, effectiveness, and degree of uncertainty determine the relationship to be applied between phases. Based on those considerations, both relationships could occur between different phases of a single project.

2.4.2.2 Predictive Life Cycles

Predictive life cycles (also known as fully plan-driven) are ones in which the project scope, and the time and cost required to deliver that scope, are determined as early in the project life cycle as practically possible. As shown in Figure 2-13, these projects proceed through a series of sequential or overlapping phases, with each phase generally focusing on a subset of project activities and project management processes. The work performed in each phase is usually different in nature to that in the preceding and subsequent phases, therefore, the makeup and skills required of the project team may vary from phase to phase.

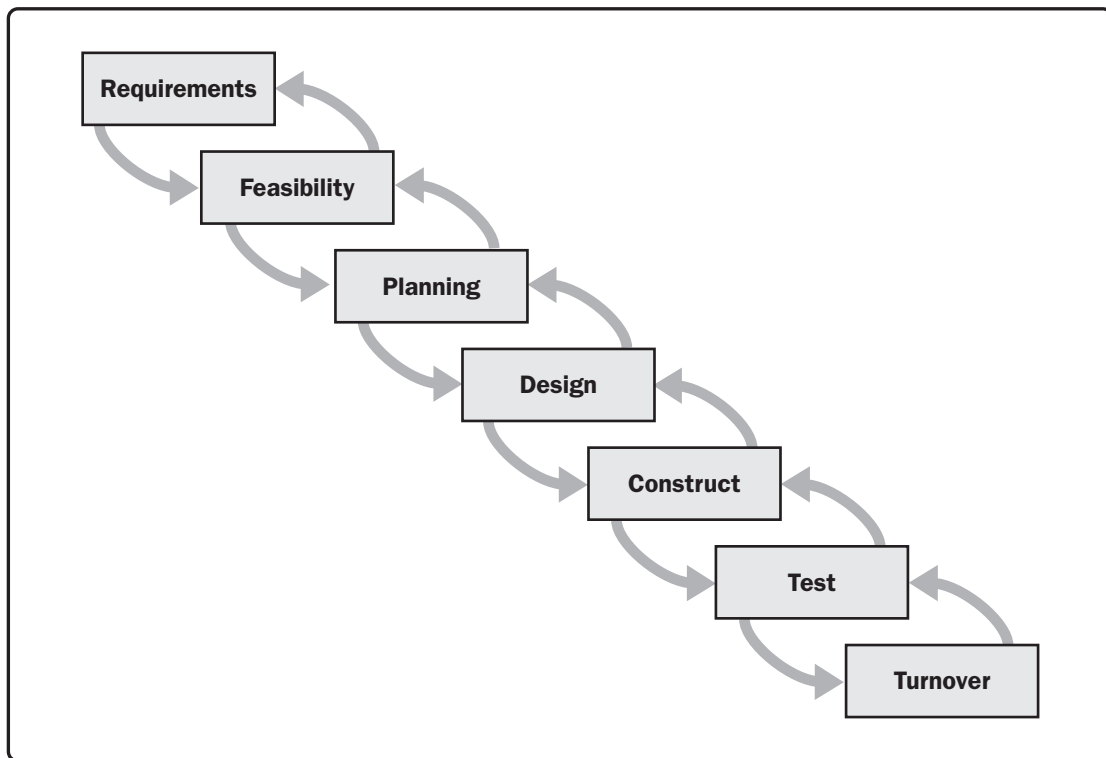

Figure 2-13. Example of Predictive Life Cycle

When the project is initiated, the project team will focus on defining the overall scope for the product and project, develop a plan to deliver the product (and any associated deliverables), and then proceed through phases to execute the plan within that scope. Changes to the project scope are carefully managed and require re planning and formal acceptance of the new scope.

Predictive life cycles are generally preferred when the product to be delivered is well understood, there is a substantial base of industry practice, or where a product is required to be delivered in full to have value to stakeholder groups.

Even projects with predictive life cycles may use the concept of rolling wave planning, where a more general, high-level plan is available and more detailed planning is executed for appropriate time windows, as new work activities are approaching and resources are to be assigned.

2.4.2.3 Iterative and Incremental Life Cycles

Iterative and incremental life cycles are ones in which project phases (also called iterations) intentionally repeat one or more project activities as the project team's understanding of the product increases. Iterations develop the product through a series of repeated cycles, while increments successively add to the functionality of the product. These life cycles develop the product both iteratively and incrementally.

Iterative and incremental projects may proceed in phases, and the iterations themselves will be performed in a sequential or overlapping fashion. During an iteration, activities from all Project Management Process Groups will be performed. At the end of each iteration, a deliverable or set of deliverables will be completed. Future iterations may enhance those deliverables or create new ones. Each iteration incrementally builds the deliverables until the exit criteria for the phase are met, allowing the project team to incorporate feedback.

In most iterative life cycles, a high-level vision will be developed for the overall undertaking, but the detailed scope is elaborated one iteration at a time. Often the planning for the next iteration is carried out as work progresses on the current iteration's scope and deliverables. The work required for a given set of deliverables may vary in duration and effort, and the project team may change between or during iterations. Those deliverables that are not addressed within the scope of the current iteration are typically scoped at a high level only and may be tentatively assigned to a specific future iteration. Changes to the scope of an iteration are carefully managed once work begins.

Iterative and incremental life cycles are generally preferred when an organization needs to manage changing objectives and scope, to reduce the complexity of a project, or when the partial delivery of a product is beneficial and provides value for one or more stakeholder groups without impact to the final deliverable or set of deliverables. Large and complex projects are frequently executed in an iterative fashion to reduce risk by allowing the team to incorporate feedback and lessons learned between iterations.

2.4.2.4 Adaptive Life Cycles

Adaptive life cycles (also known as change-driven or agile methods) are intended to respond to high levels of change and ongoing stakeholder involvement. Adaptive methods are also iterative and incremental, but differ in that iterations are very rapid (usually with a duration of 2 to 4 weeks) and are fixed in time and cost. Adaptive projects generally perform several processes in each iteration, although early iterations may concentrate more on planning activities.

The overall scope of the project will be decomposed into a set of requirements and work to be performed, sometimes referred to as a product backlog. At the beginning of an iteration, the team will work to determine how many of the highest priority items on the backlog list can be delivered within the next iteration. At the end of each iteration, the product should be ready for review by the customer. This does not mean that the customer is required to accept delivery, just that the product should not include unfinished, incomplete, or unusable features. The sponsor and customer representatives should be continuously engaged with the project to provide feedback on deliverables as they are created and to ensure that the product backlog reflects their current needs.

Adaptive methods are generally preferred when dealing with a rapidly changing environment, when requirements and scope are difficult to define in advance, and when it is possible to define small incremental improvements that will deliver value to stakeholders.

3

PROJECT MANAGEMENT PROCESSES

Project management is the application of knowledge, skills, tools, and techniques to project activities to meet the project requirements. This application of knowledge requires the effective management of the project management processes.

A process is a set of interrelated actions and activities performed to create a pre-specified product, service, or result. Each process is characterized by its inputs, the tools and techniques that can be applied, and the resulting outputs. As explained in Section 2, the project manager needs to consider organizational process assets and enterprise environmental factors. These should be taken into account for every process, even if they are not explicitly listed as inputs in the process specification. Organizational process assets provide guidelines and criteria for tailoring the organization's processes to the specific needs of the project. Enterprise environmental factors may constrain the project management options.

In order for a project to be successful, the project team should:

- Select appropriate processes required to meet the project objectives;
- Use a defined approach that can be adapted to meet requirements;
- Establish and maintain appropriate communication and engagement with stakeholders;
- Comply with requirements to meet stakeholder needs and expectations; and
- Balance the competing constraints of scope, schedule, budget, quality, resources, and risk to produce the specified product, service, or result.

The project processes are performed by the project team with stakeholder interaction and generally fall into one of two major categories:

- **Project management processes.** These processes ensure the effective flow of the project throughout its life cycle. These processes encompass the tools and techniques involved in applying the skills and capabilities described in the Knowledge Areas (Sections 4 through 13).
- **Product-oriented processes.** These processes specify and create the project's product. Product-oriented processes are typically defined by the project life cycle (as discussed in Section 2.4) and vary by application area as well as the phase of the product life cycle. The scope of the project cannot be defined without some basic understanding of how to create the specified product. For example, various construction techniques and tools need to be considered when determining the overall complexity of the house to be built.

The *PMBOK® Guide* describes only the project management processes. Although product-oriented processes are outside the scope of this document, they should not be ignored by the project manager and project team. Project management processes and product-oriented processes overlap and interact throughout the life of a project.

Project management processes apply globally and across industry groups. Good practice means there is general agreement that the application of project management processes has been shown to enhance the chances of success over a wide range of projects. Good practice does not mean that the knowledge, skills, and processes described should always be applied uniformly on all projects. For any given project, the project manager, in collaboration with the project team, is always responsible for determining which processes are appropriate, and the appropriate degree of rigor for each process.

Project managers and their teams should carefully address each process and its inputs and outputs and determine which are applicable to the project they are working on. The *PMBOK® Guide* may be used as a resource in managing a project while considering the overall approach and methodology to be followed for the project. This effort is known as tailoring.

Project management is an integrative undertaking that requires each project and product process to be appropriately aligned and connected with the other processes to facilitate coordination. Actions taken during one process typically affect that process and other related processes. For example, a scope change typically affects project cost, but it may not affect the communications management plan or level of risk. These process interactions often require tradeoffs among project requirements and objectives, and the specific performance tradeoffs will vary from project to project and organization to organization. Successful project management includes actively managing these interactions to meet sponsor, customer, and other stakeholder requirements. In some circumstances, a process or set of processes will need to be iterated several times in order to achieve the required outcome.

Projects exist within an organization and do not operate as a closed system. They require input data from the organization and beyond, and deliver capabilities back to the organization. The project processes may generate information to improve the management of future projects and organizational process assets.

The *PMBOK® Guide* describes the nature of project management processes in terms of the integration between the processes, their interactions, and the purposes they serve. Project management processes are grouped into five categories known as Project Management Process Groups (or Process Groups):

- **Initiating Process Group.** Those processes performed to define a new project or a new phase of an existing project by obtaining authorization to start the project or phase.
- **Planning Process Group.** Those processes required to establish the scope of the project, refine the objectives, and define the course of action required to attain the objectives that the project was undertaken to achieve.
- **Executing Process Group.** Those processes performed to complete the work defined in the project management plan to satisfy the project specifications.
- **Monitoring and Controlling Process Group.** Those processes required to track, review, and regulate the progress and performance of the project; identify any areas in which changes to the plan are required; and initiate the corresponding changes.
- **Closing Process Group.** Those processes performed to finalize all activities across all Process Groups to formally close the project or phase.

The remainder of this section provides information for project management of a single project organized as a network of interlinked processes, details the project management processes, and includes the following major sections:

3.1 Common Project Management Process Interactions

3.2 Project Management Process Groups

3.3 Initiating Process Group

3.4 Planning Process Group

3.5 Executing Process Group

3.6 Monitoring and Controlling Process Group

3.7 Closing Process Group

3.8 Project Information

3.9 Role of the Knowledge Areas

3.10 The Standard for Project Management of a Project

3.1 Common Project Management Process Interactions

The project management processes are presented as discrete elements with well-defined interfaces. However, in practice they overlap and interact in ways that are not completely detailed in this document. Most experienced project management practitioners recognize there is more than one way to manage a project. The required Process Groups and their processes are guides for applying appropriate project management knowledge and skills during the project. The application of the project management processes is iterative, and many processes are repeated during the project.

The integrative nature of project management requires the Monitoring and Controlling Process Group to interact with the other Process Groups, as shown in Figure 3-1. Monitoring and Controlling processes occur at the same time as processes contained within other Process Groups. Thus, the Monitoring and Controlling Process is pictured as a “background” Process Group for the other four Process Groups shown in Figure 3-1.

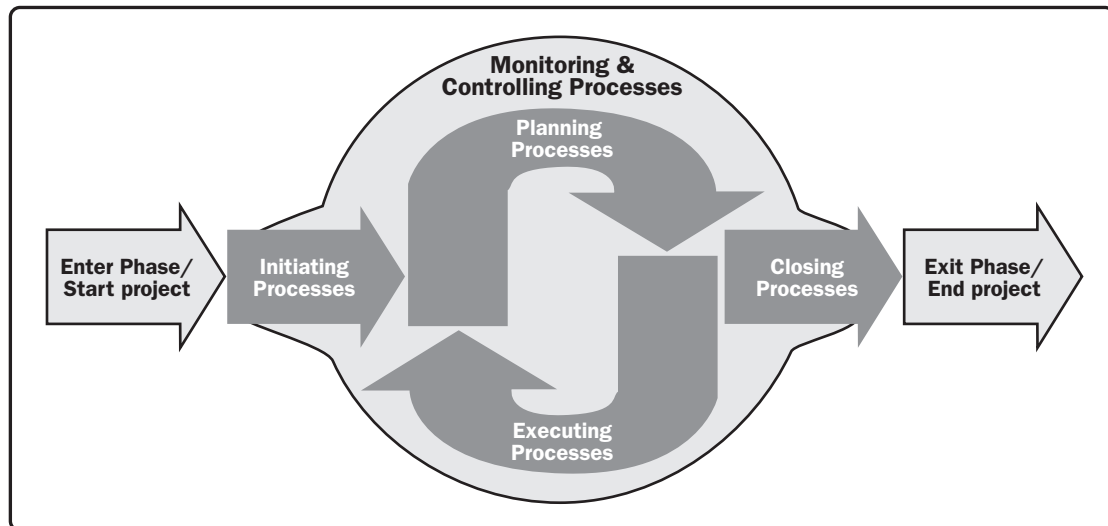

Figure 3-1. Project Management Process Groups

Project Management Process Groups are linked by the outputs which are produced. The Process Groups are seldom either discrete or one-time events; they are overlapping activities that occur throughout the project. The output of one process generally becomes an input to another process or is a deliverable of the project, subproject, or project phase. Deliverables at the subproject or project level may be called incremental deliverables. The Planning Process Group provides the Executing Process Group with the project management plan and project documents, and, as the project progresses, it often creates updates to the project management plan and the project documents. Figure 3-2 illustrates how the Process Groups interact and shows the level of overlap at various times. If the project is divided into phases, the Process Groups interact within each phase.

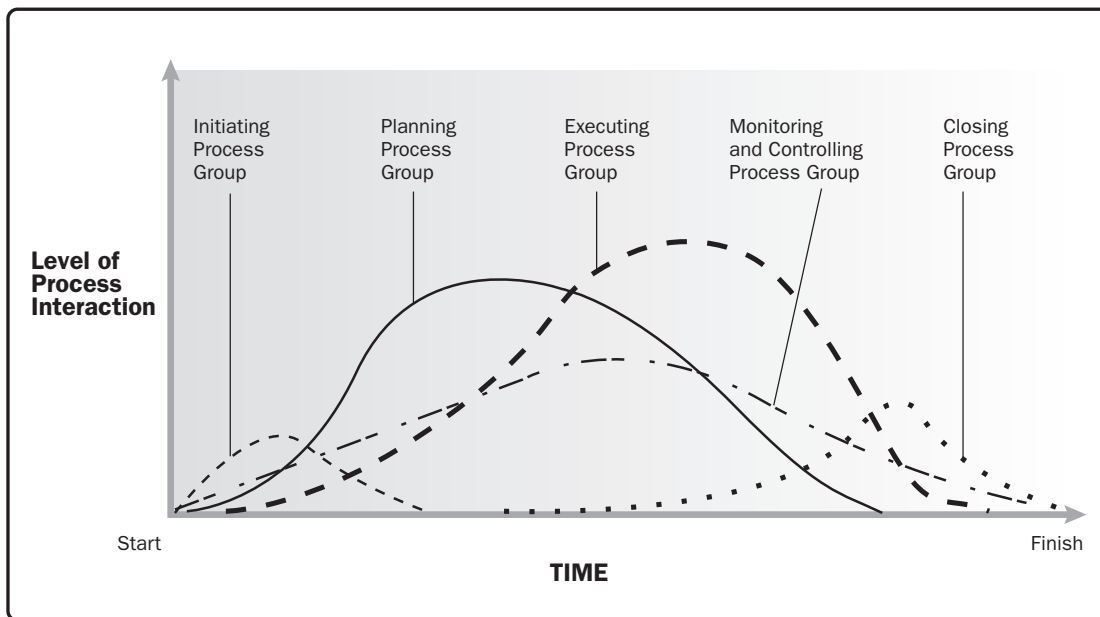

Figure 3-2. Process Groups Interact in a Phase or Project

An example of this interaction is the exit of a design phase, which requires sponsor acceptance of the design document. Once it is available, the design document provides the product description for the Planning and Executing Process Groups in one or more subsequent phases. When a project is divided into phases, the Process Groups are used, as appropriate, to effectively drive the project to completion in a controlled manner. In multiphase projects, processes are repeated within each phase until the criteria for phase completion have been satisfied. Additional information on project organization, life cycles, and project phases is provided in Section 2.

3.2 Project Management Process Groups

The following sections identify and describe the five Project Management Process Groups required for any project. These five Process Groups have clear dependencies and are typically performed in each project and highly interact with one another. These five Process Groups are independent of application areas or industry focus. Individual Process Groups and individual processes are often iterated prior to completing the project and can have interactions within a Process Group and among Process Groups. The nature of these interactions varies from project to project and may or may not be performed in a particular order.

The process flow diagram, Figure 3-3, provides an overall summary of the basic flow and interactions among Process Groups and specific stakeholders. The project management processes are linked by specific inputs and outputs where the result or outcome of one process becomes the input to another process but not necessarily in the same Process Group. **The Process Groups are not project life cycle phases.** In fact, it is possible that all Process Groups could be conducted within a phase. As projects are separated into distinct phases or subcomponents, such as concept development feasibility study, design, prototype, build, or test, etc., all of the Process Groups would normally be repeated for each phase or subcomponent along the lines explained previously and illustrated in Figure 3-2.

The project management processes are shown in the Process Group in which most of the related activities takes place. For example, a process that normally takes place in the planning phase is put into the Planning Process Group. When this process is updated by an Executing Process Group process or activity, it is not considered a new process within the Executing Process Group but is still a Planning Process Group process or activity. The iterative nature of project management means that processes from any group may be reused throughout the project life cycle. For example, in response to a risk event, executing a risk response may trigger further analysis, which leads to another iteration of the Identify Risks process and the associated Perform Quantitative Risk Analysis and Perform Quantitative Risk Analysis processes to evaluate the impact.

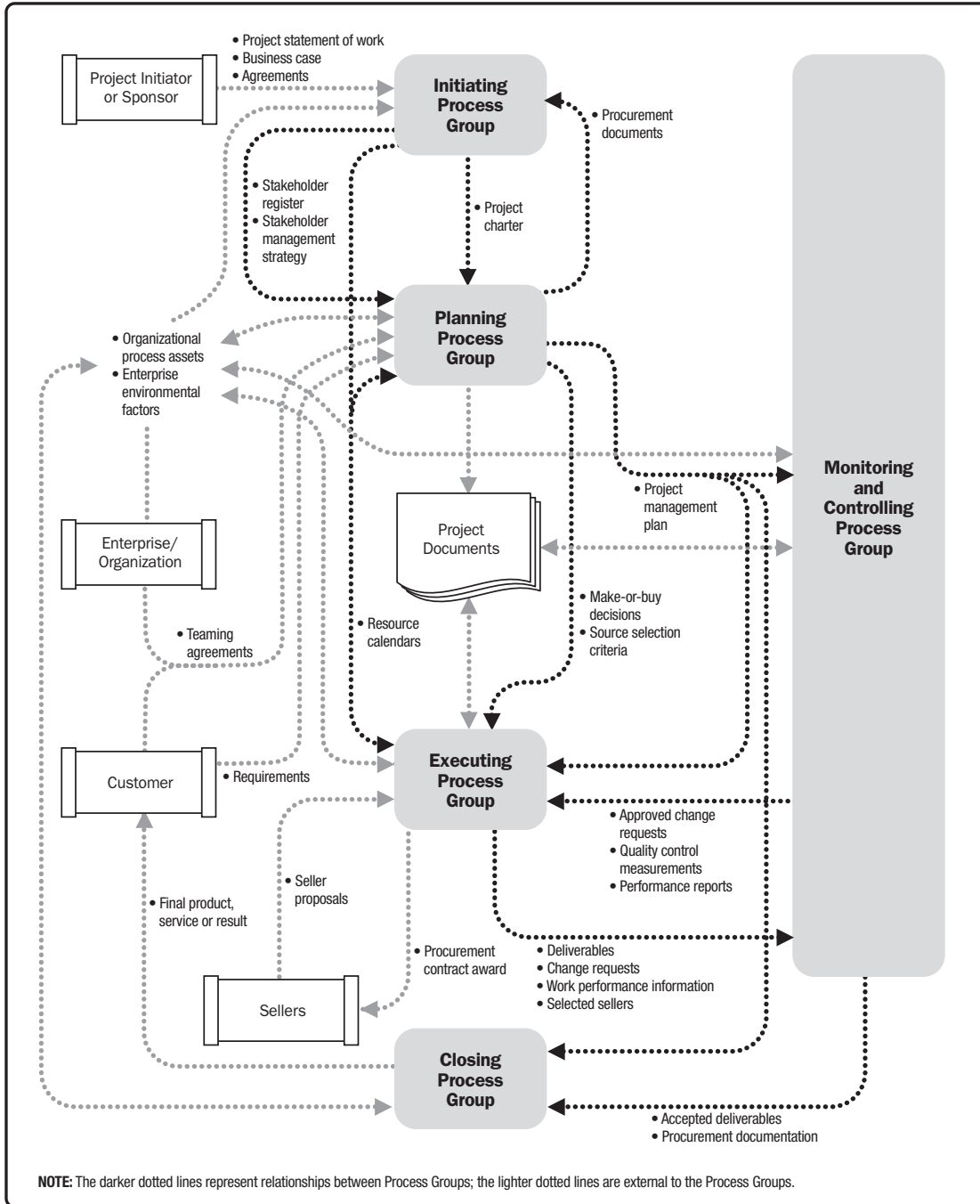

Figure 3-3. Project Management Process Interactions

3.3 Initiating Process Group

The Initiating Process Group consists of those processes performed to define a new project or a new phase of an existing project by obtaining authorization to start the project or phase. Within the Initiating processes, the initial scope is defined and initial financial resources are committed. Internal and external stakeholders who will interact and influence the overall outcome of the project are identified. If not already assigned, the project manager will be selected. This information is captured in the project charter and stakeholder register. When the project charter is approved, the project becomes officially authorized. Although the project management team may help write the project charter, this standard assumes that business case assessment, approval, and funding are handled externally to the project boundaries (Figure 3-4). A project boundary is defined as the point in time that a project or project phase is authorized to its completion. The key purpose of this Process Group is to align the stakeholders' expectations with the project's purpose, give them visibility about the scope and objectives, show how their participation in the project and its associated phases can ensure that their expectations are achieved. These processes help set the vision of the project—what is needed to be accomplished.

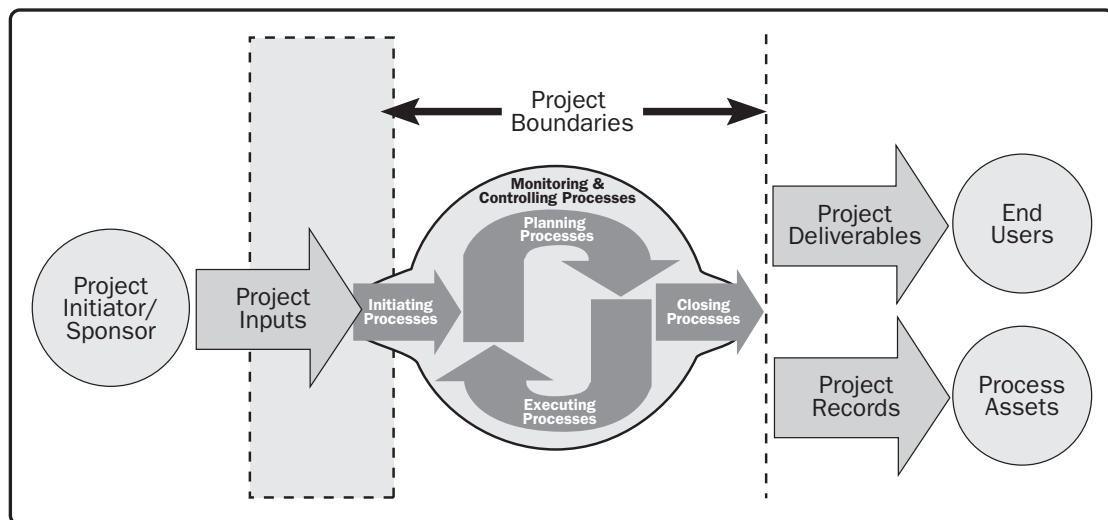

Figure 3-4. Project Boundaries

Large complex projects should be divided into separate phases. In such projects, the Initiating processes are carried out during subsequent phases to validate the decisions made during the original Develop Project Charter and Identify Stakeholders processes. Performing the Initiating processes at the start of each phase helps to keep the project focused on the business need that the project was undertaken to address. The success criteria are verified, and the influence, drivers and objectives of the project stakeholders are reviewed. A decision is then made as to whether the project should be continued, delayed, or discontinued.

Involving the sponsors, customers, and other stakeholders during initiation creates a shared understanding of success criteria, reduces the overhead of involvement, and generally improves deliverable acceptance, customer satisfaction, and other stakeholder satisfaction.

Initiating processes may be performed at the organizational, program, or portfolio level and therefore, would be outside of the project's level of control. For example, prior to commencing a project, the need for high-level requirements may be documented as part of a larger organizational initiative. A process of evaluating alternatives may be utilized to determine the feasibility of the new undertaking. Clear descriptions of the project objectives may be developed, including the reasons why a specific project is the best alternative to satisfy the requirements. The documentation for this decision may also contain the initial project scope statement, deliverables, project duration, and a forecast of the resources for the organization's investment analysis. As part of the Initiating processes, the project manager is given the authority to apply organizational resources to the subsequent project activities.

3.4 Planning Process Group

The Planning Process Group consists of those processes performed to establish the total scope of the effort, define and refine the objectives, and develop the course of action required to attain those objectives. The Planning processes develop the project management plan and the project documents that will be used to carry out the project. The complex nature of project management may require the use of repeated feedback loops for additional analysis. As more project information or characteristics are gathered and understood, additional planning will likely be required. Significant changes occurring throughout the project life cycle trigger a need to revisit one or more of the planning processes and possibly some of the initiating processes. This progressive detailing of the project management plan is called progressive elaboration, indicating that planning and documentation are iterative and ongoing activities. The key benefit of this Process Group is to delineate the strategy and tactics as well as the course of action or path to successfully complete the project or phase. When the Planning Process Group is well managed, it is much easier to get stakeholder buy-in and engagement. These processes express how this will be done, setting the route to the desired objective.

The project management plan and project documents developed as outputs from the Planning Process Group will explore all aspects of the scope, time, cost, quality, communications, human resources, risks, procurements, and stakeholder engagement.

Updates arising from approved changes during the project (generally during Monitoring and Controlling processes and specifically during the Direct and Manage Project Work Process) may significantly impact parts of the project management plan and the project documents. Updates to these documents provide greater precision with respect to schedule, costs, and resource requirements to meet the defined project scope.

The project team seeks input and encourages involvement from all stakeholders when planning the project and developing the project management plan and project documents. While the act of collecting feedback and refining the documents cannot continue indefinitely, procedures set by the organization dictate when the initial planning ends. These procedures will be affected by the nature of the project, the established project boundaries, appropriate monitoring and controlling activities, as well as the environment in which the project will be performed.

Other interactions among the processes within the Planning Process Group are dependent upon the nature of the project. For example, for some projects there will be little or no identifiable risks until after a significant amount of planning has been done. At that time, the team might recognize that the cost and schedule targets are overly aggressive, thus involving considerably more risk than previously understood. The results of the iterations are documented as updates to the project management plan or to various project documents.

3.5 Executing Process Group

The Executing Process Group consists of those processes performed to complete the work defined in the project management plan to satisfy the project specifications. This Process Group involves coordinating people and resources, managing stakeholder expectations, as well as integrating and performing the activities of the project in accordance with the project management plan.

During project execution, results may require planning updates and rebaselining. This may include changes to expected activity durations, changes in resource productivity and availability, and unanticipated risks. Such variances may affect the project management plan or project documents and may require detailed analysis and development of appropriate project management responses. The results of the analysis can trigger change requests that, if approved, may modify the project management plan or other project documents and possibly require establishing new baselines. A large portion of the project's budget will be expended in performing the Executing Process Group processes.

3.6 Monitoring and Controlling Process Group

The Monitoring and Controlling Process Group consists of those processes required to track, review, and orchestrate the progress and performance of the project; identify any areas in which changes to the plan are required; and initiate the corresponding changes. The key benefit of this Process Group is that project performance is measured and analyzed at regular intervals, appropriate events, or exception conditions to identify variances from the project management plan. The Monitoring and Controlling Process Group also involves:

- Controlling changes and recommending corrective or preventive action in anticipation of possible problems,
- Monitoring the ongoing project activities against the project management plan and the project performance measurement baseline, and
- Influencing the factors that could circumvent integrated change control or configuration management so only approved changes are implemented.

This continuous monitoring provides the project team insight into the health of the project and identifies any areas requiring additional attention. The Monitoring and Controlling Process Group not only monitors and controls the work being done within a Process Group, but also monitors and controls the entire project effort. In multiphase projects, the Monitoring and Controlling Process Group coordinates project phases in order to implement corrective or preventive actions to bring the project into compliance with the project management plan. This review can result in recommended and approved updates to the project management plan. For example, a missed activity finish date may require adjustments and trade-offs between budget and schedule objectives. In order to reduce or control overhead, management-by-exception procedures and other techniques can be appropriately considered.

3.7 Closing Process Group

The Closing Process Group consists of those processes performed to conclude all activities across all Project Management Process Groups to formally complete the project, phase, or contractual obligations. This Process Group, when completed, verifies that the defined processes are completed within all of the Process Groups to close the project or a project phase, as appropriate, and formally establishes that the project or project phase is complete.

This Process Group also formally establishes the premature closure of the project. Prematurely closed projects may include, for example: aborted projects, cancelled projects, and projects having a critical situation. In specific cases, when some contracts cannot be formally closed (e.g. claims, termination clauses, etc.) or some activities are to be transferred to other organizational units, specific hand-over procedures may be arranged and finalized.

At project or phase closure, the following may occur:

- Obtain acceptance by the customer or sponsor to formally close the project or phase,
- Conduct post-project or phase-end review,
- Record impacts of tailoring to any process,
- Document lessons learned,
- Apply appropriate updates to organizational process assets,
- Archive all relevant project documents in the project management information system (PMIS) to be used as historical data,
- Close out all procurement activities ensuring termination of all relevant agreements, and
- Perform team members' assessments and release project resources.

3.8 Project Information

Throughout the life cycle of the project, a significant amount of data and information is collected, analyzed, transformed, and distributed in various formats to project team members and other stakeholders. Project data are collected as a result of various Executing processes and are shared within the project team. The collected data are analyzed in context, and aggregated and transformed to become project information during various Controlling processes. The information may then be communicated verbally or stored and distributed as reports in various formats.

The project data are continuously collected and analyzed during the dynamic context of the project execution. As a result, the terms data and information are often used interchangeably in practice. The indiscriminate use of these terms can lead to confusion and misunderstandings by the various project stakeholders. The following guidelines help minimize miscommunication and help the project team use appropriate terminology:

- **Work performance data.** The raw observations and measurements identified during activities performed to carry out the project work. Examples include reported percent of work physically completed, quality and technical performance measures, start and finish dates of schedule activities, number of change requests, number of defects, actual costs, actual durations, etc.
- **Work performance information.** The performance data collected from various controlling processes, analyzed in context and integrated based on relationships across areas. Examples of performance information are status of deliverables, implementation status for change requests, and forecasted estimates to complete.
- **Work performance reports.** The physical or electronic representation of work performance information compiled in project documents, intended to generate decisions or raise issues, actions, or awareness. Examples include status reports, memos, justifications, information notes, electronic dashboards, recommendations, and updates.

Figure 3-5 illustrates the flow of project information across the various processes used to manage the project.

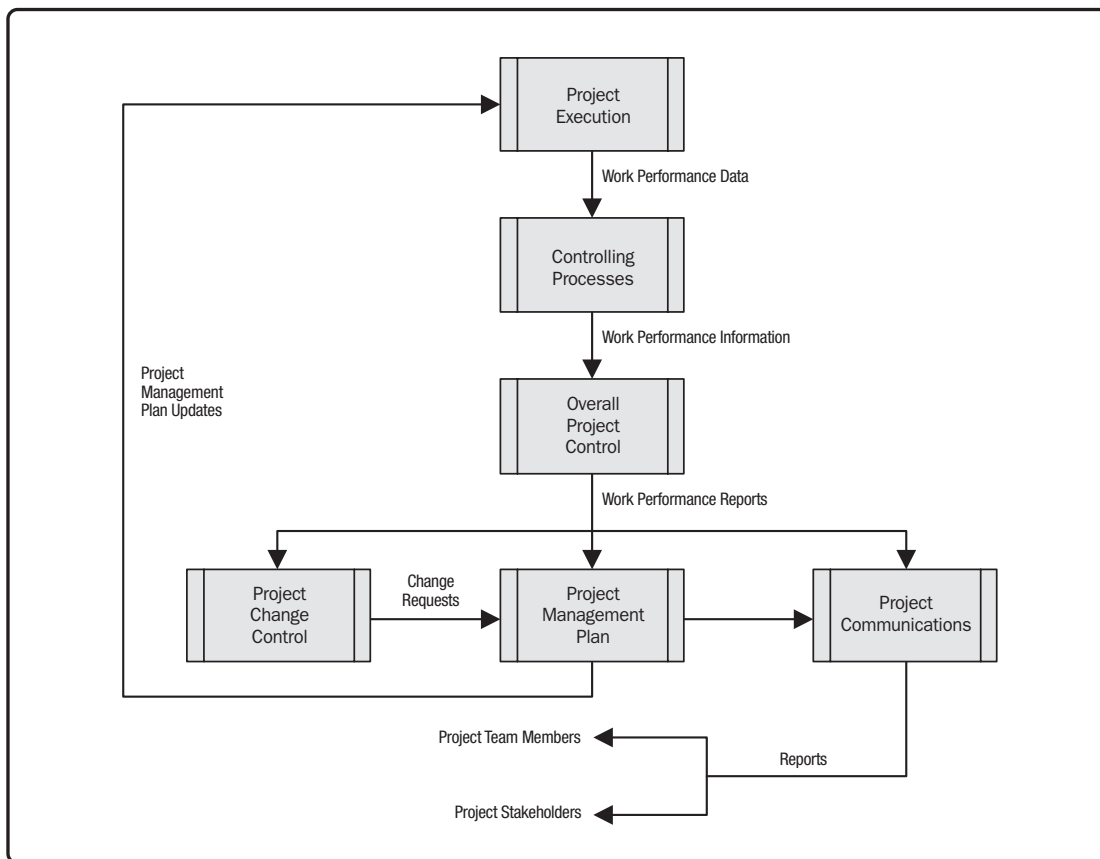

Figure 3-5. Project Data, Information and Report Flow

3.9 Role of the Knowledge Areas

The 47 project management processes identified in the *PMBOK® Guide* are further grouped into ten separate Knowledge Areas. A Knowledge Area represents a complete set of concepts, terms, and activities that make up a professional field, project management field, or area of specialization. These ten Knowledge Areas are used on most projects most of the time. Project teams should utilize these ten Knowledge Areas and other Knowledge Areas, as appropriate, for their specific project. The Knowledge Areas are: Project Integration Management, Project Scope Management, Project Time Management, Project Quality Management, Project Human Resource Management, Project Communications Management, Project Risk Management, Project Procurement Management and Project Stakeholder Management. Each Knowledge Area within the *PMBOK® Guide* is contained in a separate section.

The *PMBOK® Guide* defines the important aspects of each Knowledge Area and how it integrates with the five Process Groups. As supporting elements, the Knowledge Areas provide a detailed description of the process inputs and outputs along with a descriptive explanation of tools and techniques most frequently used within the project management processes to produce each outcome. A data flow diagram is provided in each Knowledge Area (Sections 4 through 8). The data flow diagram is a summary level depiction of the process inputs and process outputs that flow down through all the processes within a specific Knowledge Area (see Figure 3-6 for data flow diagram legend). Although the processes are presented here as discrete elements with well-defined interfaces, in practice they are iterative and can overlap and interact in ways not detailed here.

Table 3-1 reflects the mapping of the 47 project management processes within the 5 Project Management Process Groups and the 10 Knowledge Areas.

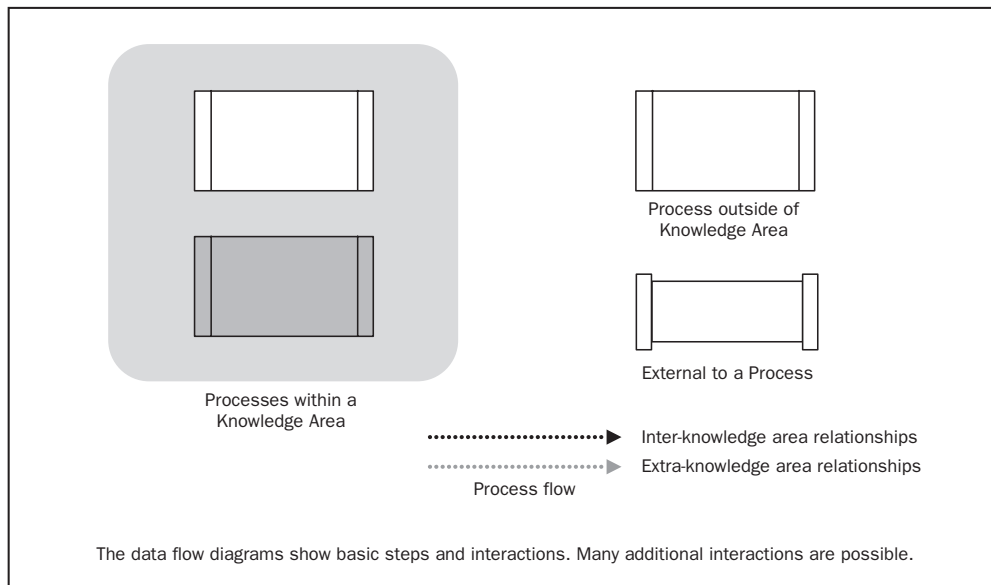

Figure 3-6. Data Flow Diagram Legend

Table 3-1. Project Management Process Group and Knowledge Area Mapping

Knowledge Areas	Project Management Process Groups				
	Initiating Process Group	Planning Process Group	Executing Process Group	Monitoring and Controlling Process Group	Closing Process Group
4. Project Integration Management	4.1 Develop Project Charter	4.2 Develop Project Management Plan	4.3 Direct and Manage Project Work	4.4 Monitor and Control Project Work 4.5 Perform Integrated Change Control	4.6 Close Project or Phase
5. Project Scope Management		5.1 Plan Scope Management 5.2 Collect Requirements 5.3 Define Scope 5.4 Create WBS		5.5 Validate Scope 5.6 Control Scope	
6. Project Time Management		6.1 Plan Schedule Management 6.2 Define Activities 6.3 Sequence Activities 6.4 Estimate Activity Resources 6.5 Estimate Activity Durations 6.6 Develop Schedule		6.7 Control Schedule	
7. Project Cost Management		7.1 Plan Cost Management 7.2 Estimate Costs 7.3 Determine Budget		7.4 Control Costs	
8. Project Quality Management		8.1 Plan Quality Management	8.2 Perform Quality Assurance	8.3 Control Quality	
9. Project Human Resource Management		9.1 Plan Human Resource Management	9.2 Acquire Project Team 9.3 Develop Project Team 9.4 Manage Project Team		
10. Project Communications Management		10.1 Plan Communications Management	10.2 Manage Communications	10.3 Control Communications	
11. Project Risk Management		11.1 Plan Risk Management 11.2 Identify Risks 11.3 Perform Qualitative Risk Analysis 11.4 Perform Quantitative Risk Analysis 11.5 Plan Risk Responses		11.6 Control Risks	
12. Project Procurement Management		12.1 Plan Procurement Management	12.2 Conduct Procurements	12.3 Control Procurements	12.4 Close Procurements
13. Project Stakeholder Management	13.1 Identify Stakeholders	13.2 Plan Stakeholder Management	13.3 Manage Stakeholder Engagement	13.4 Control Stakeholder Engagement	

4

PROJECT INTEGRATION MANAGEMENT

4

Project Integration Management includes the processes and activities to identify, define, combine, unify, and coordinate the various processes and project management activities within the Project Management Process Groups. In the project management context, integration includes characteristics of unification, consolidation, communication, and integrative actions that are crucial to controlled project execution through completion, successfully managing stakeholder expectations, and meeting requirements. Project Integration Management includes making choices about resource allocation, making trade-offs among competing objectives and alternatives, and managing the interdependencies among the project management Knowledge Areas. The project management processes are usually presented as discrete processes with defined interfaces while, in practice, they overlap and interact in ways that cannot be completely detailed in the *PMBOK® Guide*.

Figure 4-1 provides an overview of the Project Integration Management processes, which are as follows:

- 4.1 Develop Project Charter**—The process of developing a document that formally authorizes the existence of a project and provides the project manager with the authority to apply organizational resources to project activities.
- 4.2 Develop Project Management Plan**—The process of defining, preparing, and coordinating all subsidiary plans and integrating them into a comprehensive project management plan. The project's integrated baselines and subsidiary plans may be included within the project management plan.
- 4.3 Direct and Manage Project Work**—The process of leading and performing the work defined in the project management plan and implementing approved changes to achieve the project's objectives.
- 4.4 Monitor and Control Project Work**—The process of tracking, reviewing, and reporting project progress against the performance objectives defined in the project management plan.
- 4.5 Perform Integrated Change Control**—The process of reviewing all change requests; approving changes and managing changes to deliverables, organizational process assets, project documents, and the project management plan; and communicating their disposition.
- 4.6 Close Project or Phase**—The process of finalizing all activities across all of the Project Management Process Groups to formally complete the phase or project.

These processes interact with each other and with processes in other Knowledge Areas as described in detail in Section 3 and Annex A1.

The need for Project Integration Management is necessary in situations where individual processes interact. For example, a cost estimate needed for a contingency plan involves integrating the processes in the Project Cost, Time, and Risk Management Knowledge Areas. When additional risks associated with various staffing alternatives are identified, then one or more of those processes may be revisited. The project deliverables may also need integrating with ongoing operations of the performing organization, the requesting organization, and with the long-term strategic planning that takes future problems and opportunities into consideration. Project Integration Management also includes the activities needed to manage project documents to ensure consistency with the project management plan and product, service, or capability deliverables.

Most experienced project management practitioners know there is no single way to manage a project. They apply project management knowledge, skills, and required processes in a preferred order and with varying rigor to achieve the desired project performance. However, the determination that a particular process is not required does not mean that it should not be addressed. The project manager and project team need to address every process and the project environment to determine the level of implementation for each process within the project. If a project has more than one phase, the level of rigor applied within each of the project phases should be appropriate for each phase. This determination is also addressed by the project manager and project team.

The integrative nature of projects and project management can be understood by thinking of other types of activities performed while completing a project. Examples of some activities performed by the project management team are:

- Develop, review, analyze, and understand the scope. This includes the project and product requirements, criteria, assumptions, constraints, and other influences related to a project, and how each will be managed or addressed within the project;
- Transform the collected project information into a project management plan using a structured approach as described in the *PMBOK® Guide*;
- Perform activities to produce project deliverables; and
- Measure and monitor the project's progress and take appropriate action to meet project objectives.

The links among the processes in the Project Management Process Groups are often iterative in nature. For example, the Planning Process Group provides the Executing Process Group with a documented project management plan early in the project and then updates the project management plan if changes occur as the project progresses.



Figure 4-1. Project Integration Management Overview

4.1 Develop Project Charter

Develop Project Charter is the process of developing a document that formally authorizes the existence of a project and provides the project manager with the authority to apply organizational resources to project activities. The key benefit of this process is a well-defined project start and project boundaries, creation of a formal record of the project, and a direct way for senior management to formally accept and commit to the project. The inputs, tools and techniques, and outputs for this process are shown in Figure 4-2. Figure 4-3 depicts the data flow diagram of the process.



Figure 4-2. Develop Project Charter: Inputs, Tools and Techniques, and Outputs

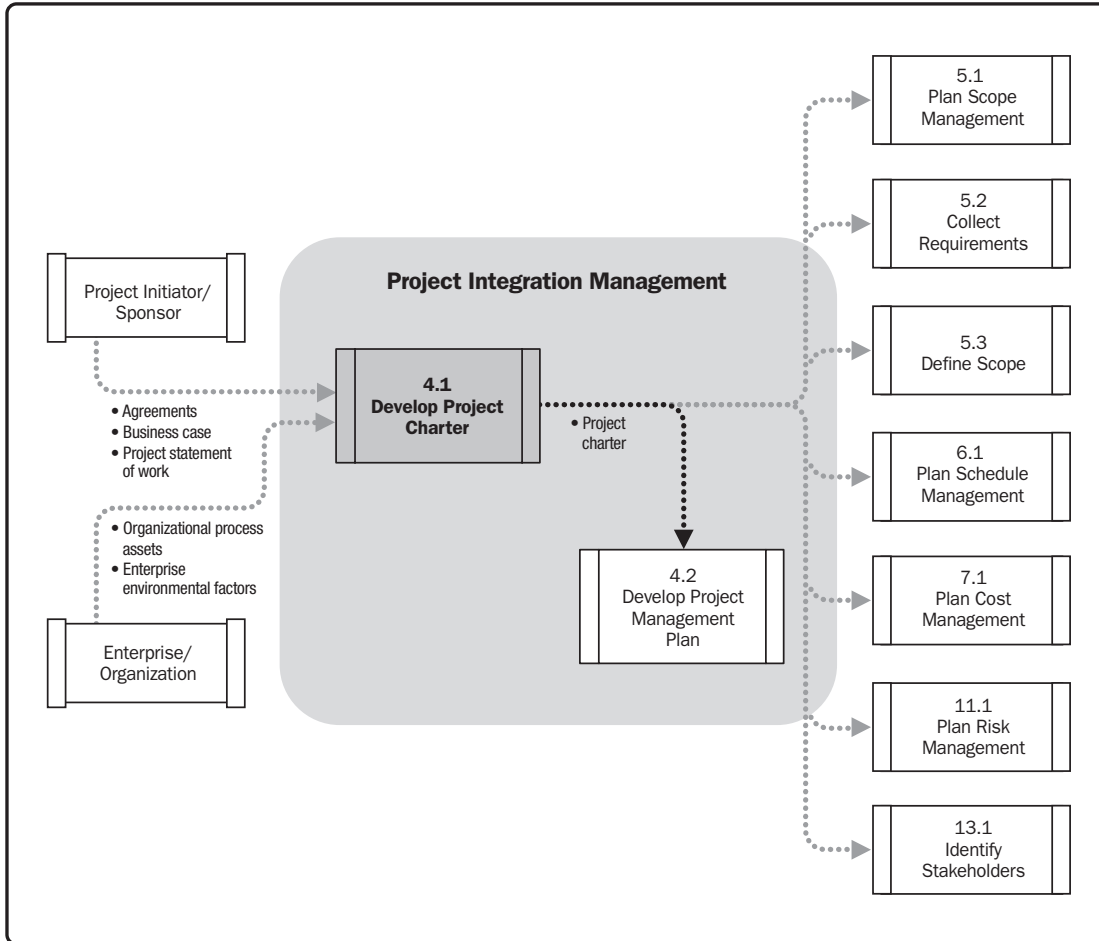

Figure 4-3. Develop Project Charter Data Flow Diagram

The project charter establishes a partnership between the performing and requesting organizations. In the case of external projects, a formal contract is typically the preferred way to establish an agreement. In this case, the project team becomes the seller responding to conditions of an offer to buy from an outside entity. A project charter is still used to establish internal agreements within an organization to assure proper delivery under the contract. The approved project charter formally initiates the project. A project manager is identified and assigned as early in the project as is feasible, preferably while the project charter is being developed and always prior to the start of planning. The project charter should be authored by the sponsoring entity. The project charter provides the project manager with the authority to plan and execute the project. It is recommended that the project manager participate in the development of the project charter to obtain a foundational understanding of the project requirements. This understanding will better allow for efficient resources allocation to project activities.

Projects are initiated by an entity external to the project such as a sponsor, program or project management office (PMO) staff person, or a portfolio governing body chairperson or authorized representative. The project initiator or sponsor should be at the level that is appropriate to procure funding and commit resources to the project. Projects are initiated due to internal business needs or external influences. These needs or influences often trigger the creation of a needs analysis, feasibility study, business case, or description of the situation that the project will address. Chartering a project validates alignment of the project to the strategy and ongoing work of the organization. A project charter is not considered to be a contract, because there is no consideration or money promised or exchanged in its creation.

4.1.1 Develop Project Charter: Inputs

4.1.1.1 Project Statement of Work

The project statement of work (SOW) is a narrative description of products, services, or results to be delivered by a project. For internal projects, the project initiator or sponsor provides the statement of work based on business needs, product, or service requirements. For external projects, the statement of work can be received from the customer as part of a bid document, (e.g., a request for proposal, request for information, or request for bid) or as part of a contract. The SOW references the following:

- **Business need.** An organization's business need may be based on a market demand, technological advance, legal requirement, government regulation, or environmental consideration. Typically, the business need and the cost-benefit analysis are contained in the business case to justify the project.
- **Product scope description.** The product scope description documents the characteristics of the product, service, or results that the project will be undertaken to create. The description should also document the relationship between the products, services, or results being created and the business need that the project will address.
- **Strategic plan.** The strategic plan documents the organization's strategic vision, goals, and objectives and may contain a high-level mission statement. All projects should be aligned with their organization's strategic plan. Strategic plan alignment ensures that each project contributes to the overall objectives of the organization.

4.1.1.2 Business Case

The business case or similar document describes the necessary information from a business standpoint to determine whether or not the project is worth the required investment. It is commonly used for decision making by managers or executives above the project level. Typically, the business need and the cost-benefit analysis are contained in the business case to justify and establish boundaries for the project, and such analysis is usually completed by a business analyst using various stakeholder inputs. The sponsor should agree to the scope and limitations of the business case. The business case is created as a result of one or more of the following:

- Market demand (e.g., a car company authorizing a project to build more fuel-efficient cars in response to gasoline shortages),
- Organizational need (e.g., due to high overhead costs a company may combine staff functions and streamline processes to reduce costs.),
- Customer request (e.g., an electric utility authorizing a project to build a new substation to serve a new industrial park),
- Technological advance (e.g., an airline authorizing a new project to develop electronic tickets instead of paper tickets based on technological advances),
- Legal requirement (e.g., a paint manufacturer authorizing a project to establish guidelines for handling toxic materials),
- Ecological impacts (e.g., a company authorizing a project to lessen its environmental impact), or
- Social need (e.g., a nongovernmental organization in a developing country authorizing a project to provide potable water systems, latrines, and sanitation education to communities suffering from high rates of cholera).

Each of the examples in this list may contain elements of risk that should be addressed. In the case of multiphase projects, the business case may be periodically reviewed to ensure that the project is on track to deliver the business benefits. In the early stages of the project life cycle, periodic review of the business case by the sponsoring organization also helps to confirm that the project is still aligned with the business case. The project manager is responsible for ensuring that the project effectively and efficiently meets the goals of the organization and those requirements of a broad set of stakeholders, as defined in the business case.

4.1.1.3 Agreements

Agreements are used to define initial intentions for a project. Agreements may take the form of contracts, memorandums of understanding (MOUs), service level agreements (SLA), letter of agreements, letters of intent, verbal agreements, email, or other written agreements. Typically, a contract is used when a project is being performed for an external customer.

4.1.1.4 Enterprise Environmental Factors

Described in Section 2.1.5. The enterprise environmental factors that can influence the Develop Project Charter process include, but are not limited to:

- Governmental standards, industry standards, or regulations (e.g. codes of conduct, quality standards, or worker protection standards),
- Organizational culture and structure, and
- Marketplace conditions.

4.1.1.5 Organizational Process Assets

Described in Section 2.1.4. The organizational process assets that can influence the Develop Project Charter process include, but are not limited to:

- Organizational standard processes, policies, and process definitions,
- Templates (e.g., project charter template), and
- Historical information and lessons learned knowledge base (e.g., projects, records, and documents; all project closure information and documentation; information about both the results of previous project selection decisions and previous project performance information; and information from the risk management activity).

4.1.2 Develop Project Charter: Tools and Techniques

4.1.2.1 Expert Judgment

Expert judgment is often used to assess the inputs used to develop the project charter. Expert judgment is applied to all technical and management details during this process. Such expertise is provided by any group or individual with specialized knowledge or training and is available from many sources, including:

- Other units within the organization,
- Consultants,
- Stakeholders, including customers or sponsors,
- Professional and technical associations,
- Industry groups,
- Subject matter experts (SME), and
- Project management office (PMO).

4.1.2.2 Facilitation Techniques

Facilitation techniques have broad application within project management processes and guide the development of the project charter. Brainstorming, conflict resolution, problem solving, and meeting management are examples of key techniques used by facilitators to help teams and individuals accomplish project activities.

4.1.3 Develop Project Charter: Outputs

4.1.3.1 Project Charter

The project charter is the document issued by the project initiator or sponsor that formally authorizes the existence of a project and provides the project manager with the authority to apply organizational resources to project activities. It documents the business needs, assumptions, constraints, the understanding of the customer's needs and high-level requirements, and the new product, service, or result that it is intended to satisfy, such as:

- Project purpose or justification,
- Measurable project objectives and related success criteria,
- High-level requirements,
- Assumptions and constraints,
- High-level project description and boundaries,
- High-level risks,
- Summary milestone schedule,
- Summary budget,
- Stakeholder list,
- Project approval requirements (i.e., what constitutes project success, who decides the project is successful, and who signs off on the project),
- Assigned project manager, responsibility, and authority level, and
- Name and authority of the sponsor or other person(s) authorizing the project charter.

4.2 Develop Project Management Plan

Develop Project Management Plan is the process of defining, preparing, and coordinating all subsidiary plans and integrating them into a comprehensive project management plan. The key benefit of this process is a central document that defines the basis of all project work. The inputs, tools and techniques, and outputs for this process are depicted in Figure 4-4. Figure 4-5 depicts the data flow diagram of the process.



Figure 4-3. Develop Project Charter Data Flow Diagram

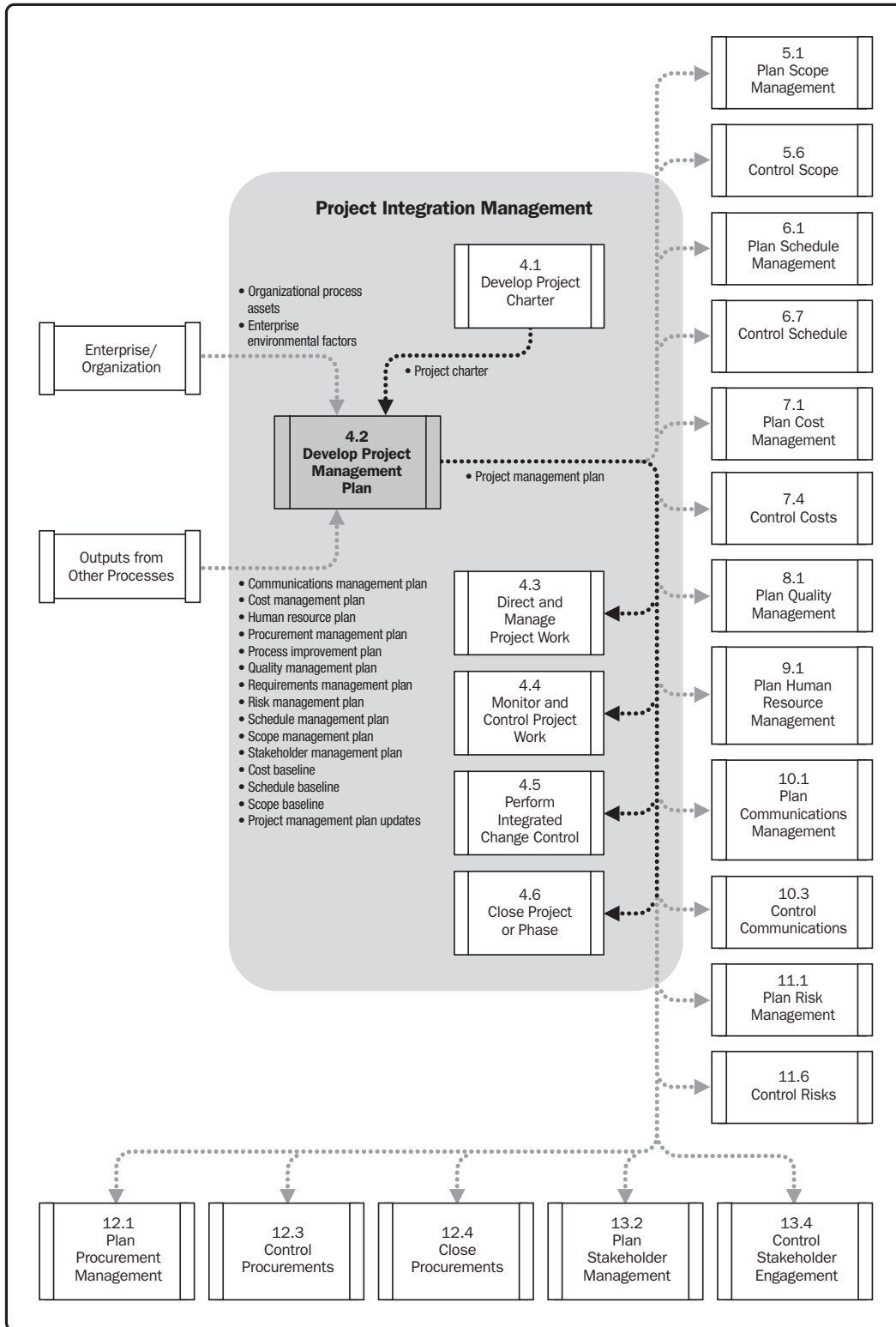

Figure 4-5. Develop Project Management Plan Data Flow Diagram

The project management plan defines how the project is executed, monitored and controlled, and closed. The project management plan's content varies depending upon the application area and complexity of the project. It is developed through a series of integrated processes extending through project closure. This process results in a project management plan that is progressively elaborated by updates, and controlled and approved through the Perform Integrated Change Control (Section 4.5) process. Projects that exist in the context of a program should develop a project management plan that is consistent with the program management plan. For example, if the program management plan indicates all changes exceeding a specified cost need to be reviewed by the change control board (CCB), then this process and cost threshold needs to be defined in the project management plan.

4.2.1 Develop Project Management Plan: Inputs

4.2.1.1 Project Charter

Described in Section 4.1.3.1. The size of the project charter varies depending on the complexity of the project and the information known at the time of its creation. At a minimum, the project charter should define the high-level boundaries of the project. The project manager uses the project charter as the starting point for initial planning throughout the Initiating Process Group.

4.2.1.2 Outputs from Other Processes

Outputs from many of the other processes described in Sections 5 through 13 are integrated to create the project management plan. Any baselines and subsidiary plans that are an output from other planning processes are inputs to this process. In addition, changes to these documents may necessitate updates to the project management plan.

4.2.1.3 Enterprise Environmental Factors

Described in Section 2.1.5. The enterprise environmental factors that can influence the Develop Project Management Plan process include, but are not limited to:

- Governmental or industry standards;
- Project management body of knowledge for vertical market (e.g., construction) and/or focus area (e.g. environmental, safety, risk, or agile software development);
- Project management information system (e.g., an automated tool, such as a scheduling software tool, a configuration management system, an information collection and distribution system, or web interfaces to other online automated systems);

- Organizational structure, culture, management practices, and sustainability;
- Infrastructure (e.g., existing facilities and capital equipment); and
- Personnel administration (e.g., hiring and termination guidelines, employee performance reviews, and employee development and training records).

4.2.1.4 Organizational Process Assets

Described in Section 2.1.4. The organizational process assets that can influence the Develop Project Management Plan process include, but are not limited to:

- Standardized guidelines, work instructions, proposal evaluation criteria, and performance measurement criteria;
- Project management plan template, including:
 - Guidelines and criteria for tailoring the organization's set of standard processes to satisfy the specific needs of the project, and
 - Project closure guidelines or requirements such as the product validation and acceptance criteria;
- Change control procedures, including the steps by which official organization standards, policies, plans, and procedures, or any project documents will be modified and how any changes will be approved and validated;
- Project files from previous projects (e.g., scope, cost, schedule and performance measurement baselines, project calendars, project schedule network diagrams, and risk registers);
- Historical information and lessons learned knowledge base; and
- Configuration management knowledge base containing the versions and baselines of all official organization standards, policies, procedures, and any project documents.

4.2.2 Develop Project Management Plan: Tools and Techniques

4.2.2.1 Expert Judgment

When developing the project management plan, expert judgment is utilized to:

- Tailor the process to meet the project needs,
- Develop technical and management details to be included in the project management plan,
- Determine resources and skill levels needed to perform project work,
- Define the level of configuration management to apply on the project,
- Determine which project documents will be subject to the formal change control process, and
- Prioritize the work on the project to ensure the project resources are allocated to the appropriate work at the appropriate time.

4.2.2.2 Facilitation Techniques

Described in Section 4.1.2.2. Facilitation techniques have broad application within project management processes and are used to guide the development of the project management plan. Brainstorming, conflict resolution, problem solving, and meeting management are key techniques used by facilitators to help teams and individuals achieve agreement to accomplish project activities.

4.2.3 Develop Project Management Plan: Outputs

4.2.3.1 Project Management Plan

The project management plan is the document that describes how the project will be executed, monitored, and controlled. It integrates and consolidates all of the subsidiary plans and baselines from the planning processes.

Project baselines include, but are not limited to:

- Scope baseline (Section 5.4.3.1),
- Schedule baseline (Section 6.6.3.1), and
- Cost baseline (Section 7.3.3.1).

Subsidiary plans include, but are not limited to:

- Scope management plan (Section 5.1.3.1),
- Requirements management plan (Section 5.1.3.2),
- Schedule management plan (Section 6.1.3.1),
- Cost management plan (Section 7.1.3.1),
- Quality management plan (Section 8.1.3.1),
- Process improvement plan (Section 8.1.3.2),
- Human resource management plan (Section 9.1.3.1),
- Communications management plan (Section 10.1.3.1),
- Risk management plan (Section 11.1.3.1),
- Procurement management plan (Section 12.1.3.1), and
- Stakeholder management plan (Section 13.2.3.1).

Among other things, the project management plan may also include the following:

- Life cycle selected for the project and the processes that will be applied to each phase;
- Details of the tailoring decisions specified by the project management team as follows:
 - Project management processes selected by the project management team,
 - Level of implementation for each selected process,
 - Descriptions of the tools and techniques to be used for accomplishing those processes, and
 - Description of how the selected processes will be used to manage the specific project, including the dependencies and interactions among those processes and the essential inputs and outputs.
- Description of how work will be executed to accomplish the project objectives;
- Change management plan that documents how changes will be monitored and controlled;
- Configuration management plan that documents how configuration management will be performed;
- Description of how the integrity of the project baselines will be maintained;
- Requirements and techniques for communication among stakeholders; and
- Key management reviews for content, the extent of, and timing to address, open issues and pending decisions.

The project management plan may be either summary level or detailed, and may be composed of one or more subsidiary plans. Each of the subsidiary plans is detailed to the extent required by the specific project. Once the project management plan is baselined, it may only be changed when a change request is generated and approved through the Perform Integrated Change Control process.

While the project management plan is one of the primary documents used to manage the project, other project documents are also used. These other documents are not part of the project management plan. Table 4-1 is a representative list of the project management plan components and project documents.

Table 4-1 Differentiation Between the Project Management Plan and Project Documents

Project Management Plan	Project Documents	
Change management plan	Activity attributes	Project staff assignments
Communications management plan	Activity cost estimates	Project statement of work
Configuration management plan	Activity duration estimates	Quality checklists
Cost baseline	Activity list	Quality control measurements
Cost management plan	Activity resource requirements	Quality metrics
Human resource management plan	Agreements	Requirements documentation
Process improvement plan	Basis of estimates	Requirements traceability matrix
Procurement management plan	Change log	Resource breakdown structure
Scope baseline <ul style="list-style-type: none"> • Project scope statement • WBS • WBS dictionary 	Change requests	Resource calendars
Quality management plan	Forecasts <ul style="list-style-type: none"> • Cost forecast • Schedule forecast 	Risk register
Requirements management plan	Issue log	Schedule data
Risk management plan	Milestone list	Seller proposals
Schedule baseline	Procurement documents	Source selection criteria
Schedule management plan	Procurement statement of work	Stakeholder register
Scope management plan	Project calendars	Team performance assessments
Stakeholder management plan	Project charter Project funding requirements Project schedule Project schedule network diagrams	Work performance data Work performance information Work performance reports

4.3 Direct and Manage Project Work

Direct and Manage Project Work is the process of leading and performing the work defined in the project management plan and implementing approved changes to achieve the project's objectives. The key benefit of this process is that it provides overall management of the project work. The inputs, tools and techniques, and outputs of this process are depicted in Figure 4-6. Figure 4-7 depicts the data flow diagram of the process.

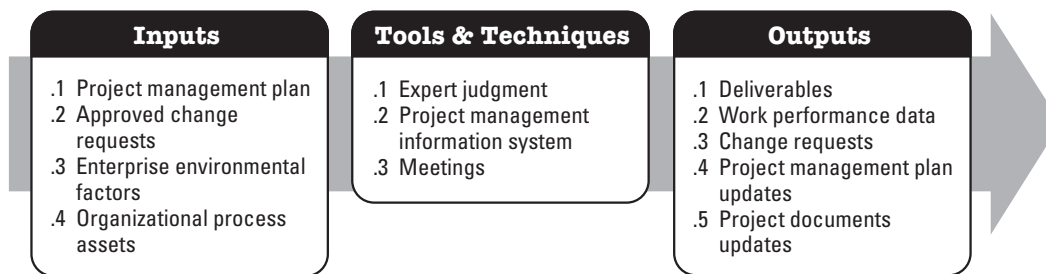

Figure 4-6. Direct and Manage Project Work: Inputs, Tools and Techniques, and Outputs

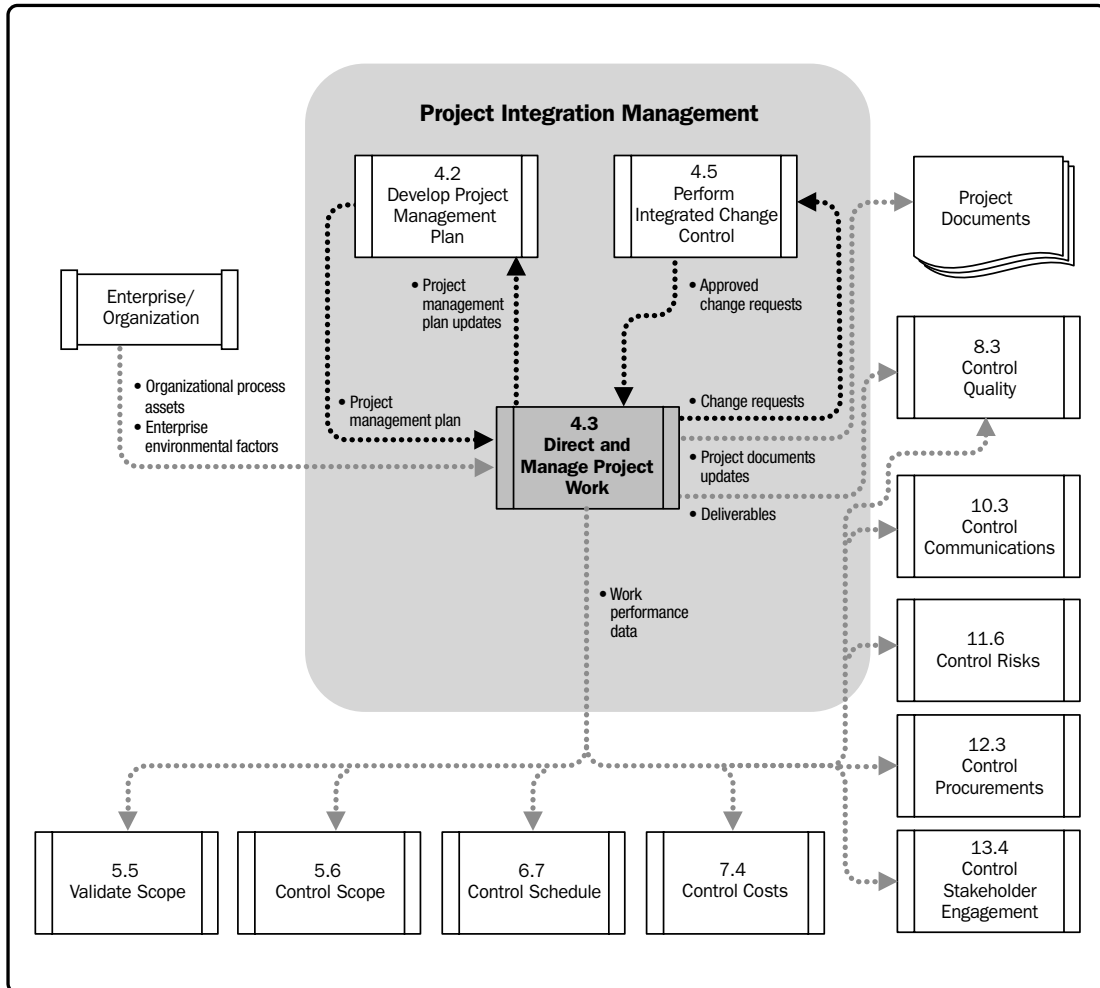

Figure 4-7. Direct and Manage Project Work: Data Flow Diagram

Direct and Manage Project Work activities include, but are not limited to:

- Perform activities to accomplish project objectives;
- Create project deliverables to meet the planned project work;
- Provide, train, and manage the team members assigned to the project;
- Obtain, manage, and use resources including materials, tools, equipment, and facilities;

- Implement the planned methods and standards;
- Establish and manage project communication channels, both external and internal to the project team;
- Generate work performance data, such as cost, schedule, technical and quality progress, and status to facilitate forecasting;
- Issue change requests and implement approved changes into the project's scope, plans, and environment;
- Manage risks and implement risk response activities;
- Manage sellers and suppliers;
- Manage stakeholders and their engagement; and
- Collect and document lessons learned and implement approved process improvement activities.

The project manager, along with the project management team, directs the performance of the planned project activities and manages the various technical and organizational interfaces that exist within the project. The project manager should also manage any unplanned activities and determine the appropriate course of action. The Direct and Manage Project Work process is directly affected by the project application area. Deliverables are produced as outputs from processes performed to accomplish the project work as planned and scheduled in the project management plan.

During project execution, the work performance data is collected and appropriately actioned and communicated. Work performance data includes information about the completion status of deliverables and other relevant details about project performance. The work performance data will also be used as an input to the Monitoring and Controlling Process Group.

Direct and Manage Project Work also requires review of the impact of all project changes and the implementation of approved changes:

- **Corrective action**—An intentional activity that realigns the performance of the project work with the project management plan;
- **Preventive action**—An intentional activity that ensures the future performance of the project work is aligned with the project management plan; and/or
- **Defect repair**—An intentional activity to modify a nonconforming product or product component.

4.3.1 Direct and Manage Project Work: Inputs

4.3.1.1 Project Management Plan

Described in Section 4.2.3.1. The project management plan contains subsidiary plans concerning all aspects of the project. Those subsidiary plans related to project work include, but are not limited to:

- Scope management plan (Section 5.1.3.1),
- Requirements management plan (Section 5.1.3.2),
- Schedule management plan (Section 6.1.3.1),
- Cost management plan (Section 7.1.3.1), and
- Stakeholder management plan (Section 13.2.3.1).

4.3.1.2 Approved Change Requests

Approved change requests are an output of the Perform Integrated Change Control process, and include those requests reviewed and approved for implementation by the change control board (CCB). The approved change request may be a corrective action, a preventative action, or a defect repair. Approved change requests are scheduled and implemented by the project team, and can impact any area of the project or project management plan. The approved change requests can also modify the policies, project management plan, procedures, costs, or budgets or revise the schedules. Approved change requests may require implementation of preventive or corrective actions.

4.3.1.3 Enterprise Environmental Factors

Described in Section 2.1.5. The Direct and Manage Project Work process is influenced by enterprise environmental factors that include, but are not limited to:

- Organizational, company, or customer culture and structure of the performing or sponsor organizations;
- Infrastructure (e.g., existing facilities and capital equipment);
- Personnel administration (e.g., hiring and firing guidelines, employee performance reviews, and training records);
- Stakeholder risk tolerances, for example allowable cost overrun percentage; and
- Project management information system (e.g., an automated tool suite, such as a scheduling software tool, a configuration management system, an information collection and distribution system, or web interfaces to other online automated systems).

4.3.1.4 Organizational Process Assets

Described in Section 2.1.4. The organizational process assets that can influence the Direct and Manage Project Work process include, but are not limited to:

- Standardized guidelines and work instructions;
- Communication requirements defining allowed communication media, record retention, and security requirements;
- Issue and defect management procedures defining issue and defect controls, issue and defect identification and resolution, and action item tracking;
- Process measurement database used to collect and make available measurement data on processes and products;
- Project files from previous projects (e.g., scope, cost, schedule, performance measurement baselines, project calendars, project schedule, network diagrams, risk registers, planned response actions, defined risk impact, and documented lessons learned); and
- Issue and defect management database(s) containing historical issue and defect status, control information, issue and defect resolution, and action item results.

4.3.2 Direct and Manage Project Work: Tools and Techniques

4.3.2.1 Expert Judgment

Expert judgment is used to assess the inputs needed to direct and manage execution of the project management plan. Such judgment and expertise are applied to all technical and management details during this process. This expertise is provided by the project manager and the project management team using specialized knowledge or training. Additional expertise is available from many sources, including:

- Other units within the organization;
- Consultants and other subject matter experts (internal and external);
- Stakeholders, including customers, suppliers, or sponsors; and
- Professional and technical associations.

4.3.2.2 Project Management Information System

The project management information system, which is part of the environmental factors, provides access to tools, such as a scheduling tool, a work authorization system, a configuration management system, an information collection and distribution system, or interfaces to other online automated systems. Automated gathering and reporting on key performance indicators (KPI) can be part of this system.

4.3.2.3 Meetings

Meetings are used to discuss and address pertinent topics of the project when directing and managing project work. Attendees at the meetings may include the project manager, the project team and appropriate stakeholders involved or affected by the topics addressed. Each attendee should have a defined role to ensure appropriate participation. Meetings tend to be one of three types:

- Information exchange;
- Brainstorming, option evaluation, or design; or
- Decision making.

Meeting types should not be mixed as a best practice. Meetings should be prepared with a well-defined agenda, purpose, objective, and time frame and should be appropriately documented with meeting minutes and action items. Meeting minutes should be stored as defined in the project management plan. Meetings are most effective when all participants can be face-to-face in the same location. Virtual meetings can be held using audio and/or video conferencing tools, but generally require additional preparation and organization to achieve the same effectiveness of a face-to-face meeting.

4.3.3 Direct and Manage Project Work: Outputs

4.3.3.1 Deliverables

A deliverable is any unique and verifiable product, result or capability to perform a service that is required to be produced to complete a process, phase, or project. Deliverables are typically tangible components completed to meet the project objectives and can include elements of the project management plan.

4.3.3.2 Work Performance Data

Work performance data are the raw observations and measurements identified during activities being performed to carry out the project work. Data are often viewed as the lowest level of detail from which information is derived by other processes. Data is gathered through work execution and passed to the controlling processes of each process area for further analysis.

Examples of work performance data include work completed, key performance indicators, technical performance measures, start and finish dates of schedule activities, number of change requests, number of defects, actual costs, and actual durations, etc.

4.3.3.3 Change Requests

A change request is a formal proposal to modify any document, deliverable, or baseline. An approved change request will replace the associated document, deliverable, or baseline and may result in an update to other parts of the project management plan. When issues are found while project work is being performed, change requests are submitted, which may modify project policies or procedures, project scope, project cost or budget, project schedule, or project quality. Other change requests cover the needed preventive or corrective actions to forestall negative impact later in the project. Requests for a change can be direct or indirect, externally or internally initiated, and can be optional or legally/contractually mandated, and may include:

- **Corrective action**—An intentional activity that realigns the performance of the project work with the project management plan;
- **Preventive action**—An intentional activity that ensures the future performance of the project work is aligned with the project management plan;
- **Defect repair**—An intentional activity to modify a nonconforming product or product component; and/or
- **Updates**—Changes to formally controlled project documents, plans, etc., to reflect modified or additional ideas or content.

4.3.3.4 Project Management Plan Updates

Elements of the project management plan that may be updated include, but are not limited to:

- Scope management plan,
- Requirements management plan,
- Schedule management plan,
- Cost management plan,
- Quality management plan,
- Process improvement plan,

- Human resource management plan,
- Communications management plan,
- Risk management plan,
- Procurement management plan,
- Stakeholder management plan, and
- Project baselines.

4.3.3.5 Project Documents Updates

Project documents that may be updated include, but are not limited to:

- Requirements documentation,
- Project logs (issues, assumptions, etc.),
- Risk register, and
- Stakeholder register.

4.4 Monitor and Control Project Work

Monitor and Control Project Work is the process of tracking, reviewing, and reporting the progress to meet the performance objectives defined in the project management plan. The key benefit of this process is that it allows stakeholders to understand the current state of the project, the steps taken, and budget, schedule, and scope forecasts. The inputs, tools and techniques, and outputs for this process are depicted in Figure 4-8. Figure 4-9 depicts the data flow diagram of the process.

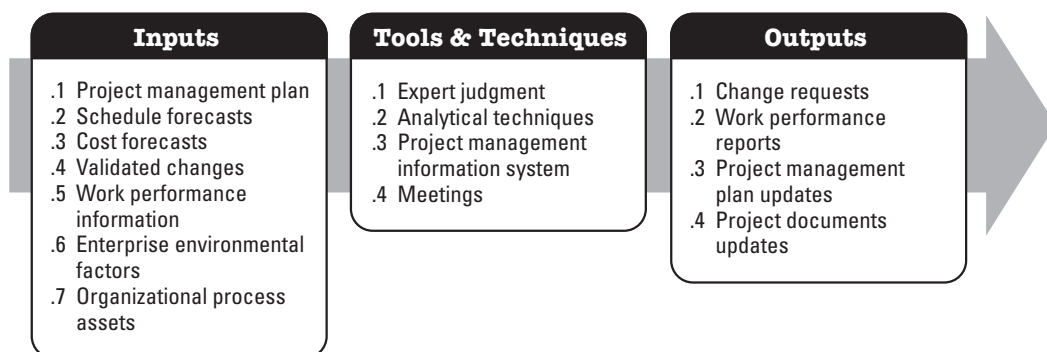

Figure 4-8. Monitor and Control Project Work: Inputs, Tools & Techniques, and Outputs

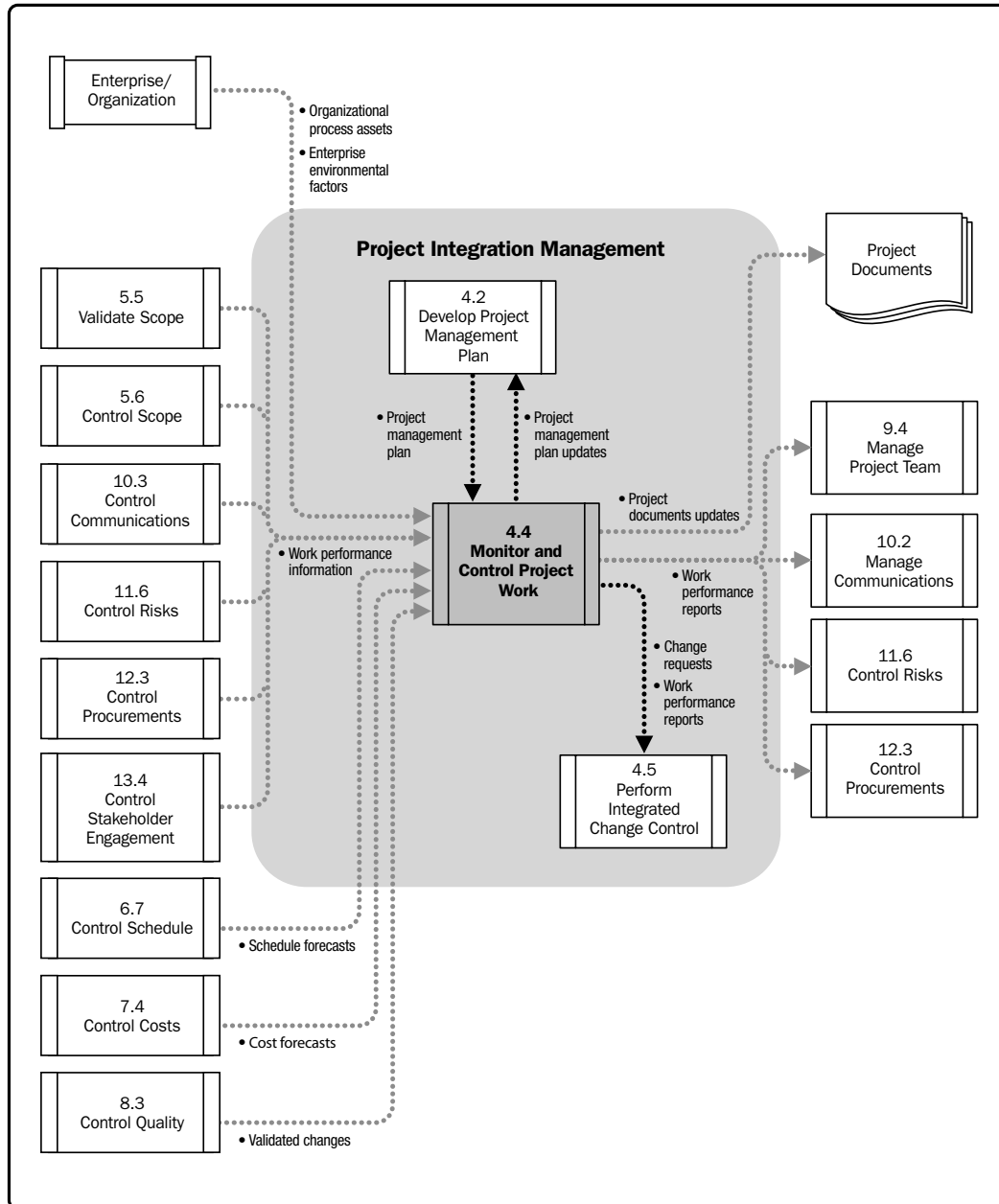

Figure 4-9. Monitor and Control Project Work Data Flow Diagram

Monitoring is an aspect of project management performed throughout the project. Monitoring includes collecting, measuring, and distributing performance information, and assessing measurements and trends to effect process improvements. Continuous monitoring gives the project management team insight into the health of the project and identifies any areas that may require special attention. Control includes determining corrective or preventive actions or replanning and following up on action plans to determine whether the actions taken resolved the performance issue. The Monitor and Control Project Work process is concerned with:

- Comparing actual project performance against the project management plan;
- Assessing performance to determine whether any corrective or preventive actions are indicated, and then recommending those actions as necessary;
- Identifying new risks and analyzing, tracking, and monitoring existing project risks to make sure the risks are identified, their status is reported, and that appropriate risk response plans are being executed;
- Maintaining an accurate, timely information base concerning the project's product(s) and their associated documentation through project completion;
- Providing information to support status reporting, progress measurement, and forecasting;
- Providing forecasts to update current cost and current schedule information;
- Monitoring implementation of approved changes as they occur; and
- Providing appropriate reporting on project progress and status to program management when the project is part of an overall program.

4.4.1 Monitor and Control Project Work: Inputs

4.4.1.1 Project Management Plan

Described in Section 4.2.3.1. Monitoring and controlling project work involves looking at all aspects of the project. Subsidiary plans within the project management plan form the basis for controlling the project. Subsidiary plans and baselines include, but are not limited to:

- Scope management plan (Section 5.1.3.1),
- Requirements management plan (Section 5.1.3.2),
- Schedule management plan (Section 6.1.3.1),
- Cost management plan (Section 7.1.3.1),
- Quality management plan (Section 8.1.3.1),
- Process improvement plan (Section 8.1.3.2),
- Human resource management plan (Section 9.1.3.1),
- Communications management plan (Section 10.1.3.1),
- Risk management plan (Section 11.1.3.1),
- Procurement management plan (Section 12.1.3.1),
- Stakeholder management plan (Section 13.2.3.1),
- Scope baseline (Section 5.4.3.1),
- Schedule baseline (Section 6.6.3.1), and
- Cost baseline (Section 7.3.3.1).

4.4.1.2 Schedule Forecasts

Described in Section 6.7.3.2. The schedule forecasts are derived from progress against the schedule baseline and computed time estimate to complete (ETC). This is typically expressed in terms of schedule variance (SV) and schedule performance index (SPI). For projects not using earned value management, variances against the planned finish dates and forecasted finish dates are provided.

The forecast may be used to determine if the project is still within defined tolerance ranges and identify any necessary change requests.

4.4.1.3 Cost Forecasts

Described in Section 7.4.3.2. The cost forecasts are derived from progress against the cost baseline and computed estimates to complete (ETC). This is typically expressed in terms of cost variance (CV) and cost performance index (CPI). An estimate at completion (EAC) can be compared to the budget at completion (BAC) to see if the project is still within tolerance ranges or if a change request is required. For projects not using earned value management, variances against the planned versus actual expenditures and forecasted final costs are provided.

4.4.1.4 Validated Changes

Described in Section 8.3.3.2. Approved changes that result from the Perform Integrated Change Control process require validation to ensure that the change was appropriately implemented. A validated change provides the necessary data to confirm that the change was appropriately executed.

4.4.1.5 Work Performance Information

Work performance information is the performance data collected from various controlling processes, analyzed in context, and integrated based on relationships across areas. Thus work performance data has been transformed into work performance information. Data in itself cannot be used in the decision-making process as it has only out-of-context meaning. Work performance information, however, is correlated and contextualized, and provides a sound foundation for project decisions.

Work performance information is circulated through communication processes. Examples of performance information are status of deliverables, implementation status for change requests, and forecasted estimates to complete.

4.4.1.6 Enterprise Environmental Factors

Described in Section 2.1.5. The enterprise environmental factors that can influence the Monitor and Control Project Work process include, but are not limited to:

- Governmental or industry standards (e.g., regulatory agency regulations, codes of conduct, product standards, quality standards, and workmanship standards),
- Organization work authorization systems,
- Stakeholder risk tolerances, and
- Project management information system (e.g., an automated tool suite, such as a scheduling software tool, a configuration management system, an information collection and distribution system, or web interfaces to other online automated systems).

4.4.1.7 Organizational Process Assets

Described in Section 2.1.4. The organizational process assets that can influence the Monitor and Control Project Work process include, but are not limited to:

- Organizational communication requirements;
- Financial controls procedures (e.g., time reporting, required expenditure and disbursement reviews, accounting codes, and standard contract provisions);
- Issue and defect management procedures defining issue and defect controls, issue and defect identification, and resolution and action item tracking;
- Change control procedures, including those for scope, schedule, cost, and quality variances;
- Risk control procedures including risk categories, probability definition and impact, and probability and impact matrix;
- Process measurement database used to make available measurement data on processes and products; and
- Lessons learned database.

4.4.2 Monitor and Control Project Work: Tools and Techniques

4.4.2.1 Expert Judgment

Expert judgment is used by the project management team to interpret the information provided by the monitor and control processes. The project manager, in collaboration with the team, determines the actions required to ensure that project performance matches expectations.

4.4.2.2 Analytical Techniques

Analytical techniques are applied in project management to forecast potential outcomes based on possible variations of project or environmental variables and their relationships with other variables. Examples of analytical techniques used in projects are:

- Regression analysis,
- Grouping methods,
- Causal analysis,

- Root cause analysis,
- Forecasting methods (e.g., time series, scenario building, simulation, etc.),
- Failure mode and effect analysis (FMEA),
- Fault tree analysis (FTA),
- Reserve analysis,
- Trend analysis,
- Earned value management, and
- Variance analysis.

4.4.2.3 Project Management Information System

The project management information system, which is part of enterprise environmental factors, provides access to automated tools, such as scheduling, cost, and resourcing tools, performance indicators, databases, project records, and financials used during the Monitor and Control Project Work process.

4.4.2.4 Meetings

Described in Section 4.3.2.3. Meetings may be face-to-face, virtual, formal, or informal. They may include project team members, stakeholders, and others involved in or affected by the project. Types of meetings include, but are not limited to, user groups and review meetings.

4.4.3 Monitor and Control Project Work: Outputs

4.4.3.1 Change Requests

As a result of comparing planned results to actual results, change requests may be issued to expand, adjust, or reduce project scope, product scope, or quality requirements and schedule or cost baselines. Change requests may necessitate the collection and documentation of new requirements. Changes can impact the project management plan, project documents, or product deliverables. Changes that meet the project's change control criteria should go through the integrated change control process established for the project. Changes may include, but are not limited to, the following:

- **Corrective action**—An intentional activity that realigns the performance of the project work with the project management plan;
- **Preventive action**—An intentional activity that ensures the future performance of the project work is aligned with the project management plan; and
- **Defect repair**—An intentional activity to modify a nonconforming product or product component.

4.4.3.2 Work Performance Reports

Work performance reports are the physical or electronic representation of work performance information compiled in project documents, intended to generate decisions, actions, or awareness. Project information may be communicated verbally from person to person. However, in order to record, store, and sometimes distribute work performance information, a physical or electronic representation in the form of project documents is required. Work performance reports are a subset of project documents, which are intended to create awareness and generate decisions or actions. Specific work performance metrics may be defined at the start of the project and included in the normal work performance reports provided to key stakeholders.

Examples of work performance reports include status reports, memos, justifications, information notes, recommendations, and updates.

4.4.3.3 Project Management Plan Updates

Changes identified during the Monitor and Control Project Work process may affect the overall project management plan. These changes, after being processed through the appropriate change control process can lead to project management plan updates. Project management plan elements that may be updated include, but are not limited to:

- Scope management plan (Section 5.1.3.1),
- Requirements management plan (Section 5.1.3.2),
- Schedule management plan (Section 6.1.3.1),
- Cost management plan (Section 7.1.3.1),
- Quality management plan (Section 8.1.3.1),
- Scope baseline (Section 5.4.3.1),
- Schedule baseline (Section 6.6.3.1), and
- Cost baseline (Section 7.3.3.1).

4.4.3.4 Project Documents Updates

Project documents that may be updated include, but are not limited to:

- Schedule and cost forecasts,
- Work performance reports, and
- Issue log.

4.5 Perform Integrated Change Control

Perform Integrated Change Control is the process of reviewing all change requests; approving changes and managing changes to deliverables, organizational process assets, project documents, and the project management plan; and communicating their disposition. It reviews all requests for changes or modifications to project documents, deliverables, baselines, or the project management plan and approves or rejects the changes. The key benefit of this process is that it allows for documented changes within the project to be considered in an integrated fashion while reducing project risk, which often arises from changes made without consideration to the overall project objectives or plans. The inputs, tools and techniques, and outputs of this process are depicted in Figure 4-10. Figure 4-11 depicts the data flow diagram of the process.

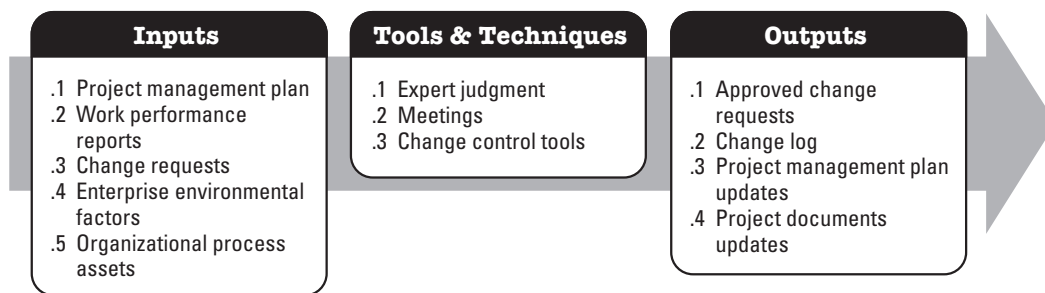

Figure 4-10. Perform Integrated Change Control: Inputs, Tools & Techniques, and Outputs

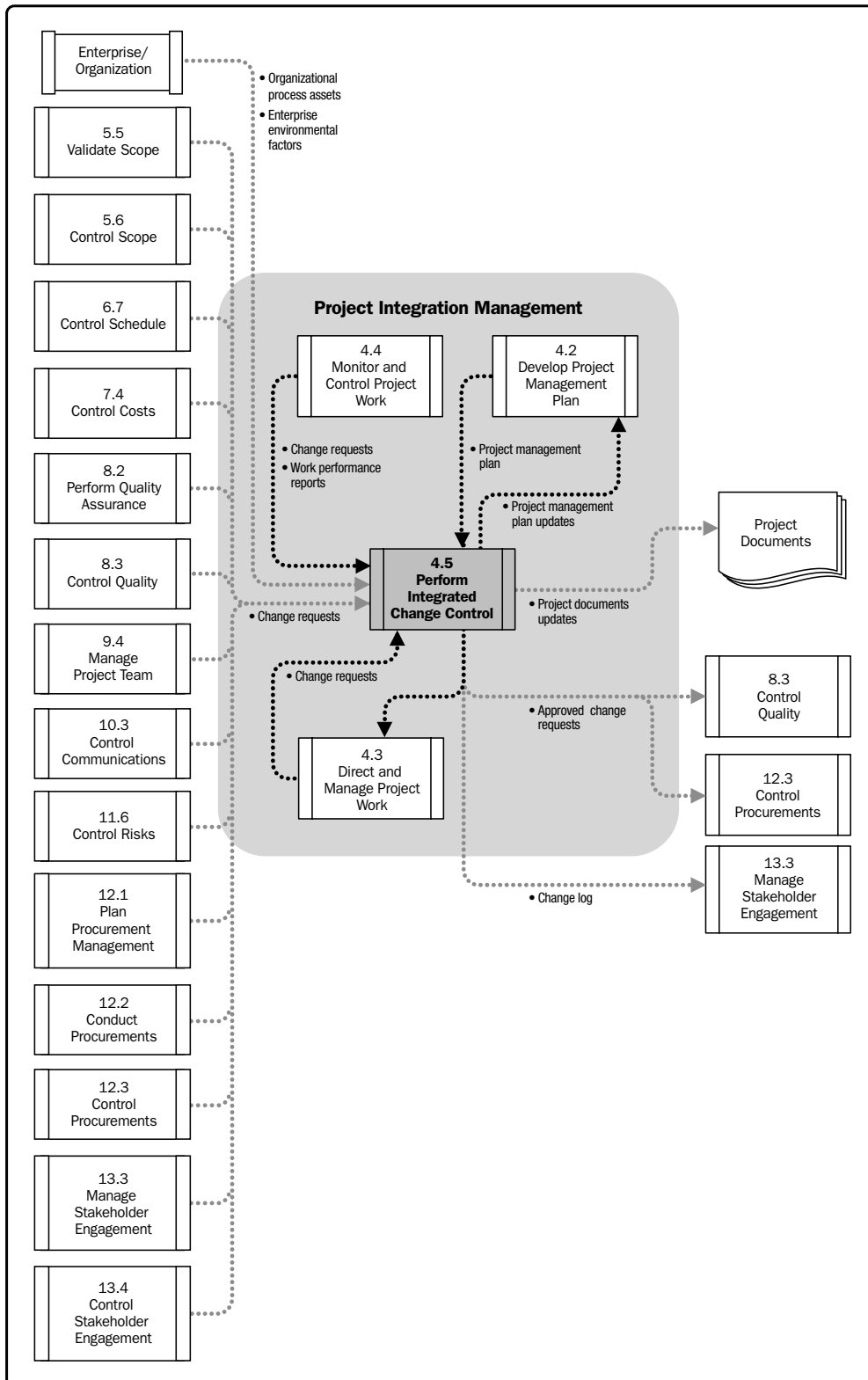

Figure 4-11. Perform Integrated Change Control Data Flow Diagram

The Perform Integrated Change Control process is conducted from project inception through completion and is the ultimate responsibility of the project manager. The project management plan, the project scope statement, and other deliverables are maintained by carefully and continuously managing changes, either by rejecting changes or by approving changes, thereby assuring that only approved changes are incorporated into a revised baseline.

Changes may be requested by any stakeholder involved with the project. Although changes may be initiated verbally, they should be recorded in written form and entered into the change management and/or configuration management system. Change requests are subject to the process specified in the change control and configuration control systems. Those change request processes may require information on estimated time impacts and estimated cost impacts.

Every documented change request needs to be either approved or rejected by a responsible individual, usually the project sponsor or project manager. The responsible individual will be identified in the project management plan or by organizational procedures. When required, the Perform Integrated Change Control process includes a change control board (CCB), which is a formally chartered group responsible for reviewing, evaluating, approving, delaying, or rejecting changes to the project, and for recording and communicating such decisions. Approved change requests can require new or revised cost estimates, activity sequences, schedule dates, resource requirements, and analysis of risk response alternatives. These changes can require adjustments to the project management plan and other project documents. The applied level of change control is dependent upon the application area, complexity of the specific project, contract requirements, and the context and environment in which the project is performed. Customer or sponsor approval may be required for certain change requests after CCB approval, unless they are part of the CCB.

Configuration control is focused on the specification of both the deliverables and the processes; while change control is focused on identifying, documenting, and approving or rejecting changes to the project documents, deliverables, or baselines.

Some of the configuration management activities included in the Perform Integrated Change Control process are as follows:

- **Configuration identification.** Identification and selection of a configuration item to provide the basis for which the product configuration is defined and verified, products and documents are labeled, changes are managed, and accountability is maintained.

- **Configuration status accounting.** Information is recorded and reported as to when appropriate data about the configuration item should be provided. This information includes a listing of approved configuration identification, status of proposed changes to the configuration, and the implementation status of approved changes.
- **Configuration verification and audit.** Configuration verification and configuration audits ensure the composition of a project's configuration items is correct and that corresponding changes are registered, assessed, approved, tracked, and correctly implemented. This ensures the functional requirements defined in the configuration documentation have been met.

4.5.1 Perform Integrated Change Control: Inputs

4.5.1.1 Project Management Plan

Described in Section 4.2.3.1. Elements of the project management plan that may be used include, but are not limited to:

- Scope management plan, which contains the procedures for scope changes;
- Scope baseline, which provides product definition; and
- Change management plan, which provides the direction for managing the change control process and documents the formal change control board (CCB).

Changes are documented and updated within the project management plan as part of the change and configuration management processes.

4.5.1.2 Work Performance Reports

Described in Section 4.4.3.2. Work performance reports of particular interest to the Perform Integrated Change Control process include resource availability, schedule and cost data, and earned value management (EVM) reports, burnup or burndown charts.

4.5.1.3 Change Requests

All of the Monitoring and Controlling processes and many of the Executing processes produce change requests as an output. Change requests may include corrective action, preventive action, and defect repairs. However, corrective and preventive actions do not normally affect the project baselines—only the performance against the baselines.

4.5.1.4 Enterprise Environmental Factors

Described in Section 2.1.5. The following enterprise environmental factor can influence the Perform Integrated Change Control process: project management information system. The project management information system may include the scheduling software tool, a configuration management system, an information collection and distribution system, or web interfaces to other online automated systems.

4.5.1.5 Organizational Process Assets

Described in Section 2.1.4. The organizational process assets that can influence the Perform Integrated Change Control process include, but are not limited to:

- Change control procedures, including the steps by which official organization standards, policies, plans, and other project documents will be modified, and how any changes will be approved, validated, and implemented;
- Procedures for approving and issuing change authorizations;
- Process measurement database used to collect and make available measurement data on processes and products;
- Project documents (e.g., scope, cost, and schedule baselines, project calendars, project schedule network diagrams, risk registers, planned response actions, and defined risk impact); and
- Configuration management knowledge base containing the versions and baselines of all official organization standards, policies, procedures, and any project documents.

4.5.2 Perform Integrated Change Control: Tools and Techniques

4.5.2.1 Expert Judgment

In addition to the project management team's expert judgment, stakeholders may be asked to provide their expertise and may be asked to sit on the change control board (CCB). Such judgment and expertise are applied to any technical and management details during this process and may be provided by various sources, for example:

- Consultants,
- Stakeholders, including customers or sponsors,
- Professional and technical associations,
- Industry groups,
- Subject matter experts (SMEs), and
- Project management office (PMO).

4.5.2.2 Meetings

In this case, these meetings are usually referred to as change control meetings. When needed for the project, a change control board (CCB) is responsible for meeting and reviewing the change requests and approving, rejecting, or other disposition of those changes. The CCB may also review configuration management activities. The roles and responsibilities of these boards are clearly defined and agreed upon by appropriate stakeholders and documented in the change management plan. CCB decisions are documented and communicated to the stakeholders for information and follow-up actions.

4.5.2.3 Change Control Tools

In order to facilitate configuration and change management, manual or automated tools may be used. Tool selection should be based on the needs of the project stakeholders including organizational and environmental considerations and/or constraints.

Tools are used to manage the change requests and the resulting decisions. Additional considerations should be made for communication to assist the CCB members in their duties as well as distribute the decisions to the appropriate stakeholders.

4.5.3 Perform Integrated Change Control: Outputs

4.5.3.1 Approved Change Requests

Change requests are processed according to the change control system by the project manager, CCB, or by an assigned team member. Approved change requests will be implemented through the Direct and Manage Project Work process. The disposition of all change requests, approved or not, will be updated in the change log as part of updates to the project documents.

4.5.3.2 Change Log

A change log is used to document changes that occur during a project. These changes and their impact to the project in terms of time, cost, and risk, are communicated to the appropriate stakeholders. Rejected change requests are also captured in the change log.

4.5.3.3 Project Management Plan Updates

Elements of the project management plan that may be updated include, but are not limited to:

- Any subsidiary plans, and
- Baselines that are subject to the formal change control process.

Changes to baselines should only show the changes from the current time forward. Past performance may not be changed. This protects the integrity of the baselines and the historical data of past performance.

4.5.3.4 Project Documents Updates

Project documents that may be updated as a result of the Perform Integrated Change Control process include all documents specified as being subject to the project's formal change control process.

4.6 Close Project or Phase

Close Project or Phase is the process of finalizing all activities across all of the Project Management Process Groups to formally complete the project or phase. The key benefit of this process is that it provides lessons learned, the formal ending of project work, and the release of organization resources to pursue new endeavors. The inputs, tools and techniques, and outputs of this process are depicted in Figure 4-12. Figure 4-13 depicts the data flow diagram of the process.



Figure 4-12. Close Project or Phase: Inputs, Tools & Techniques, and Outputs

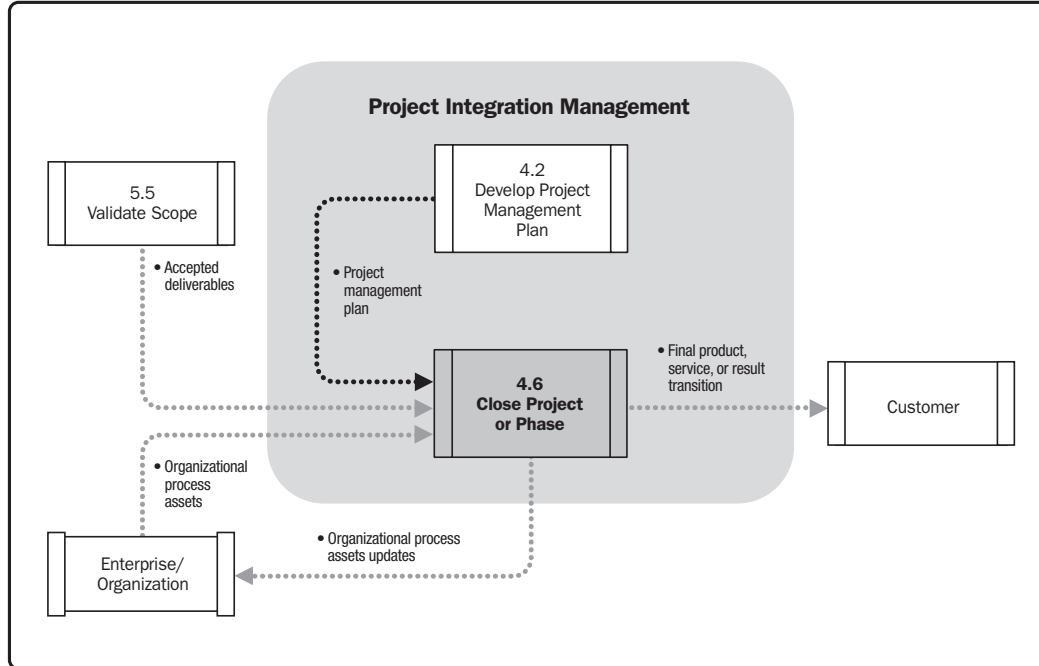

Figure 4-13. Close Project or Phase Data Flow Diagram

When closing the project, the project manager reviews all prior information from the previous phase closures to ensure that all project work is completed and that the project has met its objectives. Since project scope is measured against the project management plan, the project manager reviews the scope baseline to ensure completion before considering the project closed. The Close Project or Phase process also establishes the procedures to investigate and document the reasons for actions taken if a project is terminated before completion. In order to successfully achieve this, the project manager needs to engage all the proper stakeholders in the process.

This includes all planned activities necessary for administrative closure of the project or phase, including step-by-step methodologies that address:

- Actions and activities necessary to satisfy completion or exit criteria for the phase or project;
- Actions and activities necessary to transfer the project's products, services, or results to the next phase or to production and/or operations; and
- Activities needed to collect project or phase records, audit project success or failure, gather lessons learned and archive project information for future use by the organization.

4.6.1 Close Project or Phase: Inputs

4.6.1.1 Project Management Plan

Described in Section 4.2.3.1. The project management plan becomes the agreement between the project manager and project sponsor, defining what constitutes project completion.

4.6.1.2 Accepted Deliverables

Described in Section 5.5. Accepted deliverables may include approved product specifications, delivery receipts, and work performance documents. Partial or interim deliverables may also be included for phased or cancelled projects.

4.6.1.3 Organizational Process Assets

Described in Section 2.1.4. The organizational process assets that can influence the Close Project or Phase process include, but are not limited to:

- Project or phase closure guidelines or requirements (e.g., administrative procedures, project audits, project evaluations, and transition criteria); and
- Historical information and lessons learned knowledge base (e.g., project records and documents, all project closure information and documentation, information about both the results of previous project selection decisions and previous project performance information, and information from risk management activities).

4.6.2 Close Project or Phase: Tools and Techniques

4.6.2.1 Expert Judgment

Expert judgment is applied when performing administrative closure activities. These experts ensure the project or phase closure is performed to the appropriate standards. Expertise is available from many sources, including but not limited to

- Other project managers within the organization,
- Project management office (PMO), and
- Professional and technical associations.

4.6.2.2 Analytical Techniques

Described in Section 4.4.2.2. Examples of analytical techniques used in project closeout are:

- Regression analysis, and
- Trend analysis.

4.6.2.3 Meetings

Described in Section 4.3.2.3. Meetings may be face-to-face, virtual, formal, or informal. This may include project team members and other stakeholders, involved in or affected by the project. Types of meetings include, but are not limited to lessons learned, closeout, user group, and review meetings.

4.6.3 Close Project or Phase: Outputs

4.6.3.1 Final Product, Service, or Result Transition

This output refers to the transition of the final product, service, or result that the project was authorized to produce (or in the case of phase closure, the intermediate product, service, or result of that phase).

4.6.3.2 Organizational Process Assets Updates

The organizational process assets that are updated as a result of the Close Project or Phase process include, but are not limited to:

- **Project files**—Documentation resulting from the project's activities, for example, project management plan; scope, cost, schedule, and project calendars; risk registers and other registers; change management documentation; planned risk response actions; and risk impact.
- **Project or phase closure documents**—Project or phase closure documents, consisting of formal documentation that indicates completion of the project or phase and the transfer of the completed project or phase deliverables to others, such as an operations group or to the next phase. During project closure, the project manager reviews prior phase documentation, customer acceptance documentation from the Validate Scope process (Section 5.4), and the contract (if applicable), to ensure that all project requirements are completed prior to finalizing the closure of the project. If the project was terminated prior to completion, the formal documentation indicates why the project was terminated and formalizes the procedures for the transfer of the finished and unfinished deliverables of the cancelled project to others.
- **Historical information**—Historical information and lessons learned information are transferred to the lessons learned knowledge base for use by future projects or phases. This can include information on issues and risks as well as techniques that worked well that can be applied to future projects.

5

PROJECT SCOPE MANAGEMENT

Project Scope Management includes the processes required to ensure that the project includes all the work required, and only the work required, to complete the project successfully. Managing the project scope is primarily concerned with defining and controlling what is and is not included in the project.

Figure 5-1 provides an overview of the Project Scope Management processes, which include the following:

- 5.1 Plan Scope Management**—The process of creating a scope management plan that documents how the project scope will be defined, validated, and controlled.
- 5.2 Collect Requirements**—The process of determining, documenting, and managing stakeholder needs and requirements to meet project objectives.
- 5.3 Define Scope**—The process of developing a detailed description of the project and product.
- 5.4 Create WBS**—The process of subdividing project deliverables and project work into smaller, more manageable components.
- 5.5 Validate Scope**—The process of formalizing acceptance of the completed project deliverables.
- 5.6 Control Scope**—The process of monitoring the status of the project and product scope and managing changes to the scope baseline.

These processes interact with each other and with processes in other Knowledge Areas as described in detail in Section 3 and Annex A1.

In the project context, the term scope can refer to:

- **Product scope.** The features and functions that characterize a product, service, or result; and/or
- **Project scope.** The work performed to deliver a product, service, or result with the specified features and functions. The term project scope is sometimes viewed as including product scope.

The processes used to manage project scope, as well as the supporting tools and techniques, can vary by project. The scope baseline for the project is the approved version of the project scope statement, work breakdown structure (WBS), and its associated WBS dictionary. A baseline can be changed only through formal change control procedures and is used as a basis for comparison while performing Validate Scope and Control Scope processes as well as other controlling processes.

Completion of the project scope is measured against the project management plan (Section 4.2.3.1). Completion of the product scope is measured against the product requirements (Section 5.2). The Project Scope Management processes need to be well integrated with the other Knowledge Area processes, so that the work of the project will result in delivery of the specified product scope.

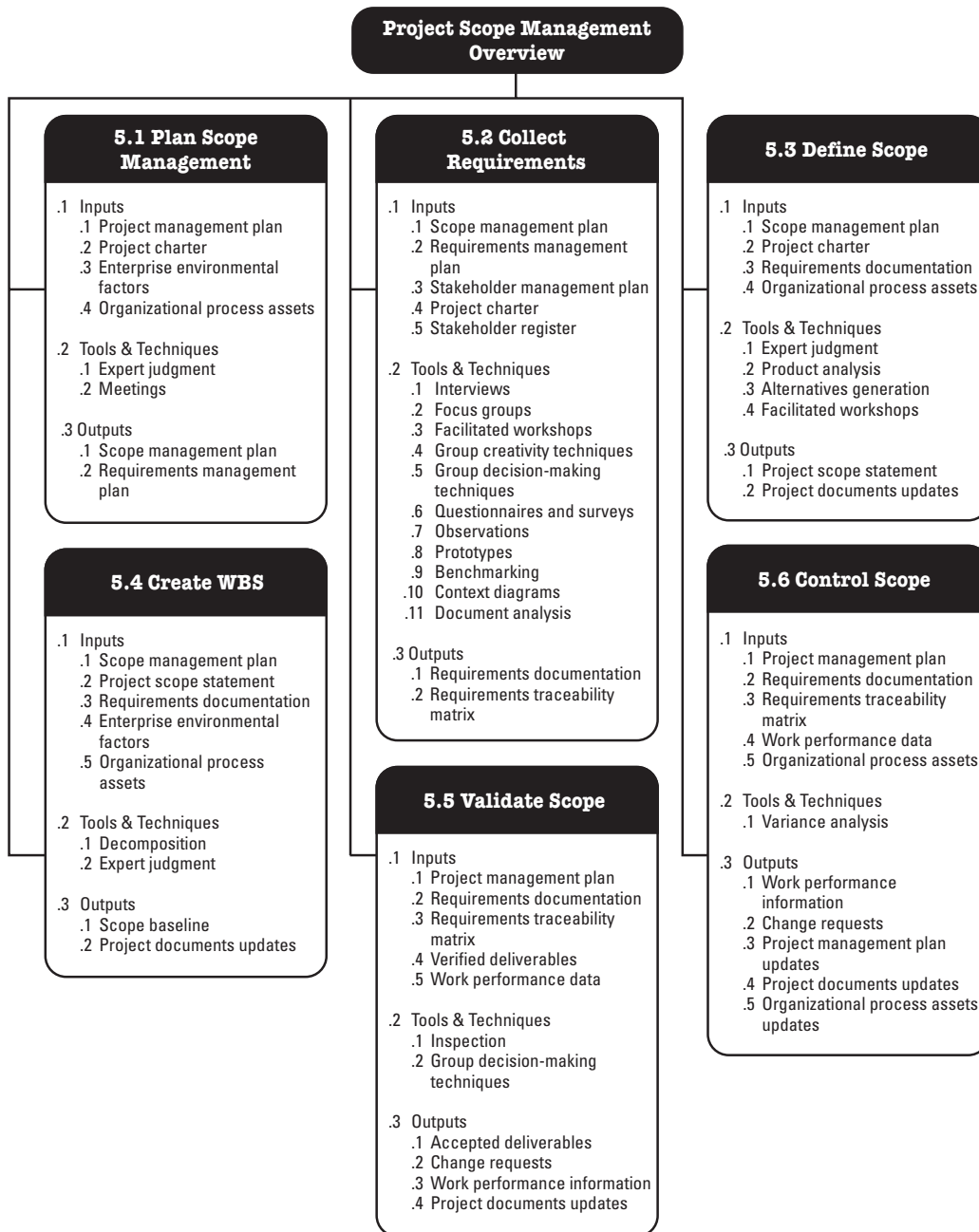

Figure 5-1. Project Scope Management Overview

5.1 Plan Scope Management

Plan Scope Management is the process of creating a scope management plan that documents how the project scope will be defined, validated, and controlled. The key benefit of this process is that it provides guidance and direction on how scope will be managed throughout the project. The inputs, tools and techniques, and outputs of this process are depicted in Figure 5-2. Figure 5-3 depicts the data flow diagram of the process.

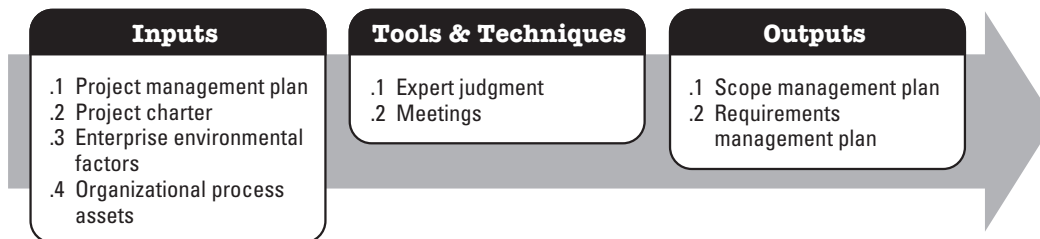

Figure 5-2. Plan Scope Management: Inputs, Tools & Techniques, and Outputs

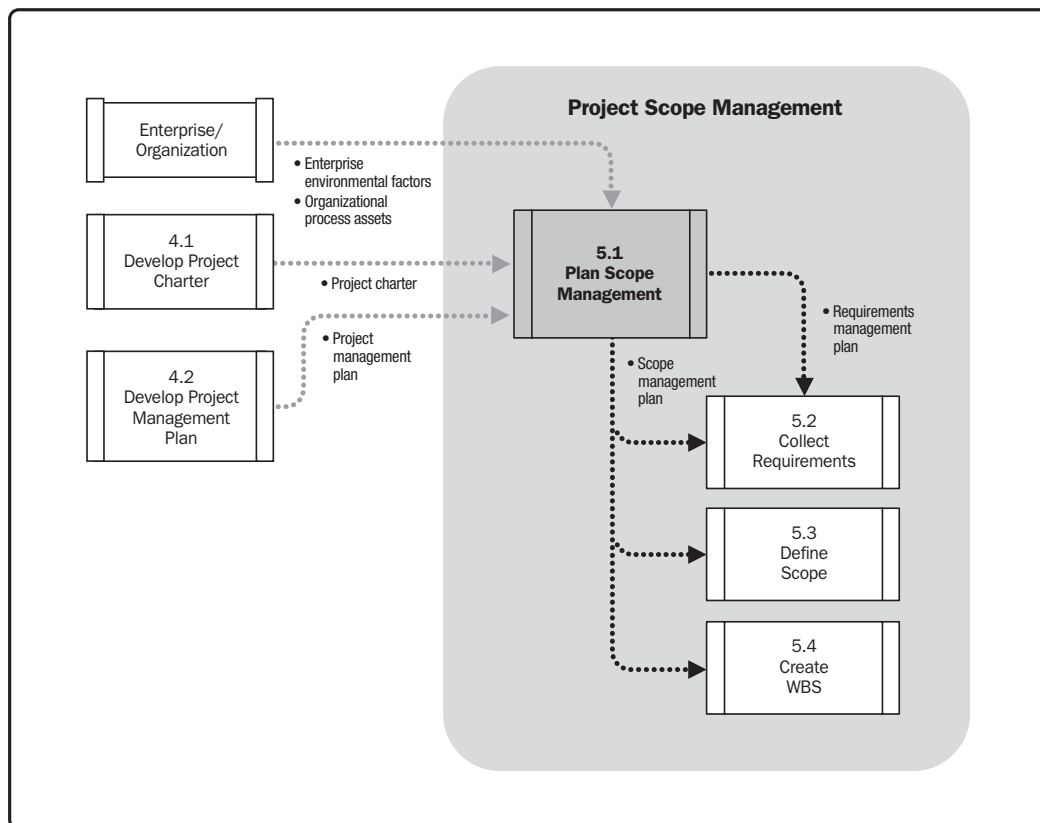

Figure 5-3. Plan Scope Management Data Flow Diagram

The scope management plan is a component of the project or program management plan that describes how the scope will be defined, developed, monitored, controlled, and verified. The development of the scope management plan and the detailing of the project scope begin with the analysis of information contained in the project charter (Section 4.1.3.1), the latest approved subsidiary plans of the project management plan (Section 4.2.3.1), historical information contained in the organizational process assets (Section 2.1.4), and any other relevant enterprise environmental factors (Section 2.1.5). This plan helps reduce the risk of project scope creep.

5.1.1 Plan Scope Management: Inputs

5.1.1.1 Project Management Plan

Described in Section 4.2.3.1. Approved subsidiary plans of the project management plan are used to create the scope management plan and influence the approach taken for planning scope and managing project scope.

5.1.1.2 Project Charter

Described in Section 4.1.3.1. The project charter is used to provide the project context needed to plan the scope management processes. It provides the high-level project description and product characteristics from the project statement of work.

5.1.1.3 Enterprise Environmental Factors

Described in Section 2.1.5. The enterprise environmental factors that can influence the Plan Scope Management process include, but are not limited to:

- Organization's culture,
- Infrastructure,
- Personnel administration, and
- Marketplace conditions.

5.1.1.4 Organizational Process Assets

Described in Section 2.1.4. The organizational process assets that can influence the Plan Scope Management process include, but are not limited to:

- Policies and procedures, and
- Historical information and lessons learned knowledge base.

5.1.2 Plan Scope Management: Tools and Techniques

5.1.2.1 Expert Judgment

Expert judgment refers to input received from knowledgeable and experienced parties. Expertise may be provided by any group or person with specialized education, knowledge, skill, experience, or training in developing scope management plans.

5.1.2.2 Meetings

Project teams may attend project meetings to develop the scope management plan. Attendees at these meetings may include the project manager, the project sponsor, selected project team members, selected stakeholders, anyone with responsibility for any of the scope management processes, and others as needed.

5.1.3 Plan Scope Management: Outputs

5.1.3.1 Scope Management Plan

The scope management plan is a component of the project or program management plan that describes how the scope will be defined, developed, monitored, controlled, and verified. The scope management plan is a major input into the Develop Project Management Plan process, and the other scope management processes. The components of a scope management plan include:

- Process for preparing a detailed project scope statement;
- Process that enables the creation of the WBS from the detailed project scope statement;
- Process that establishes how the WBS will be maintained and approved;
- Process that specifies how formal acceptance of the completed project deliverables will be obtained; and
- Process to control how requests for changes to the detailed project scope statement will be processed. This process is directly linked to the Perform Integrated Change Control process (Section 4.5).

The scope management plan can be formal or informal, broadly framed or highly detailed, based on the needs of the project.

5.1.3.2 Requirements Management Plan

The requirements management plan is a component of the project management plan that describes how requirements will be analyzed, documented, and managed. The phase-to-phase relationship, described in Section 2.4.2.1, strongly influences how requirements are managed. The project manager chooses the most effective relationship for the project and documents this approach in the requirements management plan. Many of the requirements management plan components are based on that relationship.

Components of the requirements management plan can include, but are not limited to:

- How requirements activities will be planned, tracked, and reported;
- Configuration management activities such as: how changes to the product will be initiated, how impacts will be analyzed, how they will be traced, tracked, and reported, as well as the authorization levels required to approve these changes;
- Requirements prioritization process;
- Product metrics that will be used and the rationale for using them; and
- Traceability structure to reflect which requirement attributes will be captured on the traceability matrix.

5.2 Collect Requirements

Collect Requirements is the process of determining, documenting, and managing stakeholder needs and requirements to meet project objectives. The key benefit of this process is that it provides the basis for defining and managing the project scope including product scope. The inputs, tools and techniques, and outputs of this process are depicted in Figure 5-4. Figure 5-5 depicts the data flow diagram of the process.

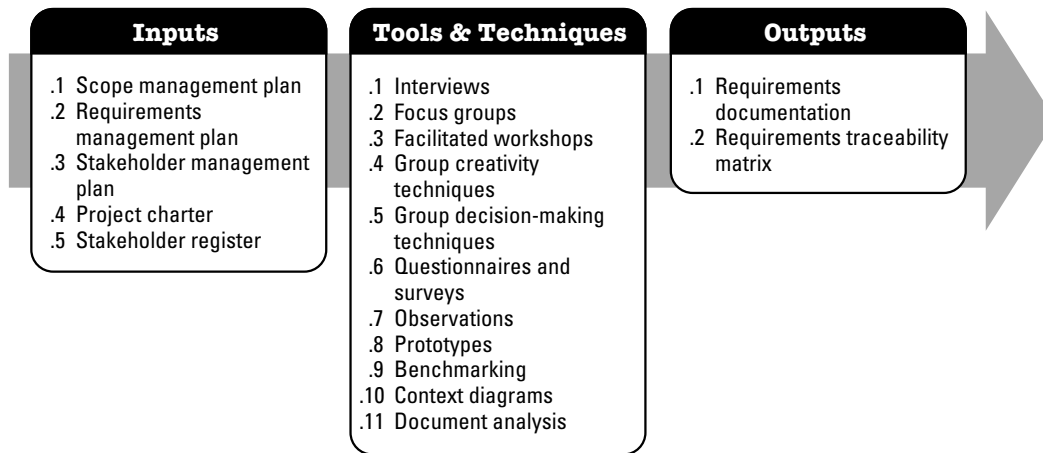

Figure 5-4. Collect Requirements: Inputs, Tools & Techniques, and Outputs

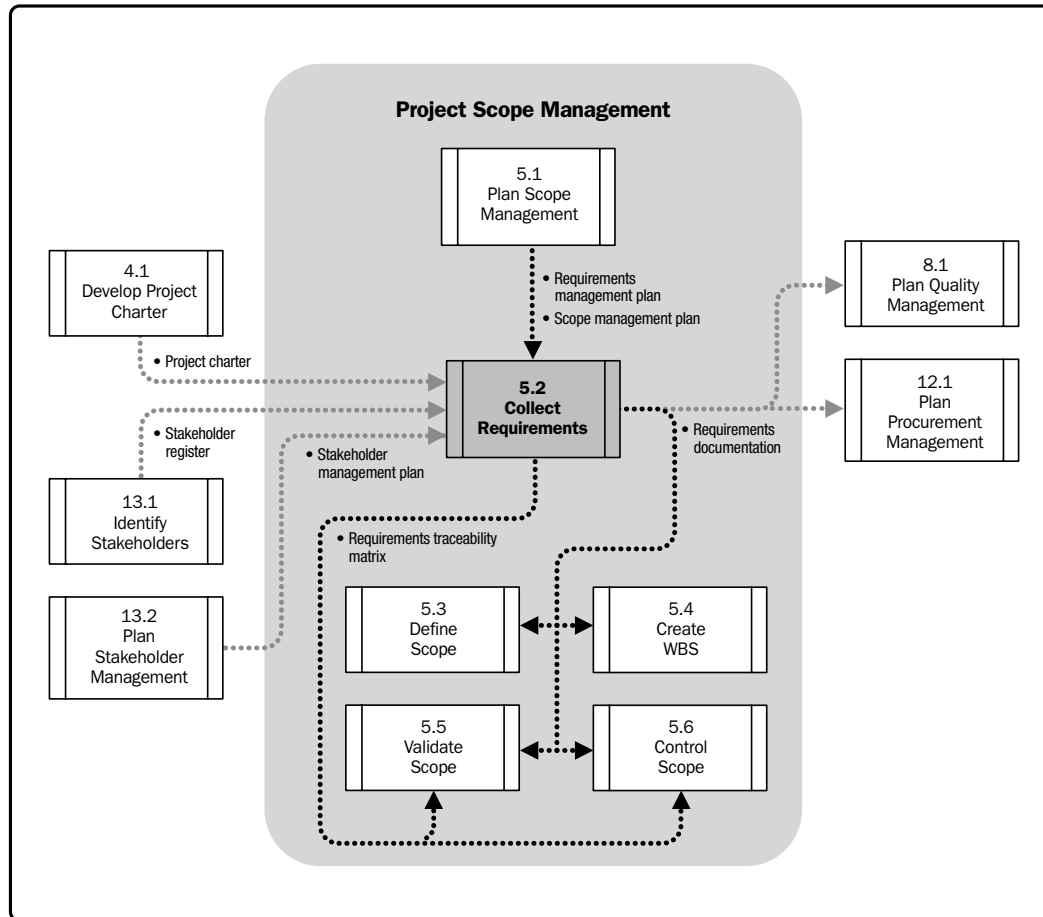

Figure 5-5. Collect Requirements Data Flow Diagram

The project's success is directly influenced by active stakeholder involvement in the discovery and decomposition of needs into requirements and by the care taken in determining, documenting, and managing the requirements of the product, service, or result of the project. Requirements include conditions or capabilities that are to be met by the project or present in the product, service, or result to satisfy an agreement or other formally imposed specification. Requirements include the quantified and documented needs and expectations of the sponsor, customer, and other stakeholders. These requirements need to be elicited, analyzed, and recorded in enough detail to be included in the scope baseline and to be measured once project execution begins. Requirements become the foundation of the WBS. Cost, schedule, quality planning, and sometimes procurement are all based upon these requirements. The development of requirements begins with an analysis of the information contained in the project charter (Section 4.1.3.1), the stakeholder register (Section 13.1.3.1) and the stakeholder management plan (Section 13.2.3.1).

Many organizations categorize requirements into different types, such as business and technical solutions, the former referring to stakeholder needs and the latter as to how those needs will be implemented. Requirements can be grouped into classifications allowing for further refinement and detail as the requirements are elaborated. These classifications include:

- Business requirements, which describe the higher-level needs of the organization as a whole, such as the business issues or opportunities, and reasons why a project has been undertaken.
- Stakeholder requirements, which describe needs of a stakeholder or stakeholder group.
- Solution requirements, which describe features, functions, and characteristics of the product, service, or result that will meet the business and stakeholder requirements. Solution requirements are further grouped into functional and nonfunctional requirements:
 - Functional requirements describe the behaviors of the product. Examples include processes, data, and interactions with the product.
 - Nonfunctional requirements supplement functional requirements and describe the environmental conditions or qualities required for the product to be effective. Examples include: reliability, security, performance, safety, level of service, supportability, retention/purge, etc.
- Transition requirements describe temporary capabilities, such as data conversion and training requirements, needed to transition from the current “as-is” state to the future “to-be” state.
- Project requirements, which describe the actions, processes, or other conditions the project needs to meet.
- Quality requirements, which capture any condition or criteria needed to validate the successful completion of a project deliverable or fulfillment of other project requirements.

5.2.1 Collect Requirements: Inputs

5.2.1.1 Scope Management Plan

Described in Section 5.1.3.1. The scope management plan provides clarity as to how project teams will determine which type of requirements need to be collected for the project.

5.2.1.2 Requirements Management Plan

Described in Section 5.1.3.2. The requirements management plan provides the processes that will be used throughout the Collect Requirements process to define and document the stakeholder needs.

5.2.1.3 Stakeholder Management Plan

Described in Section 13.2.3.1. The stakeholder management plan is used to understand stakeholder communication requirements and the level of stakeholder engagement in order to assess and adapt to the level of stakeholder participation in requirements activities.

5.2.1.4 Project Charter

Described in Section 4.1.3.1. The project charter is used to provide the high-level description of the product, service, or result of the project so that detailed requirements can be developed.

5.2.1.5 Stakeholder Register

Described in Section 13.1.3.1. The stakeholder register is used to identify stakeholders who can provide information on the requirements. The stakeholder register also captures major requirements and main expectations stakeholders may have for the project.

5.2.2 Collect Requirements: Tools and Techniques

5.2.2.1 Interviews

An interview is a formal or informal approach to elicit information from stakeholders by talking to them directly. It is typically performed by asking prepared and spontaneous questions and recording the responses. Interviews are often conducted on an individual basis between an interviewer and an interviewee, but may involve multiple interviewers and/or multiple interviewees. Interviewing experienced project participants, sponsors and other executives, and subject matter experts can aid in identifying and defining the features and functions of the desired product deliverables. Interviews are also useful for obtaining confidential information.

5.2.2.2 Focus Groups

Focus groups bring together prequalified stakeholders and subject matter experts to learn about their expectations and attitudes about a proposed product, service, or result. A trained moderator guides the group through an interactive discussion, designed to be more conversational than a one-on-one interview.

5.2.2.3 Facilitated Workshops

Facilitated workshops are focused sessions that bring key stakeholders together to define product requirements. Workshops are considered a primary technique for quickly defining cross-functional requirements and reconciling stakeholder differences. Because of their interactive group nature, well-facilitated sessions can build trust, foster relationships, and improve communication among the participants, which can lead to increased stakeholder consensus. In addition, issues can be discovered earlier and resolved more quickly than in individual sessions.

For example, facilitated workshops called joint application design/development (JAD) sessions are used in the software development industry. These facilitated sessions focus on bringing business subject matter experts and the development team together to improve the software development process. In the manufacturing industry, quality function deployment (QFD) is another example of a facilitated workshop technique that helps determine critical characteristics for new product development. QFD starts by collecting customer needs, also known as voice of the customer (VOC). These needs are then objectively sorted and prioritized, and goals are set for achieving them. User stories, which are short, textual descriptions of required functionality, are often developed during a requirements workshop. User stories describe the stakeholder who benefits from the feature (role), what the stakeholder needs to accomplish (goal), and the benefit to the stakeholder (motivation). User stories are widely used with agile methods.

5.2.2.4 Group Creativity Techniques

Several group activities can be organized to identify project and product requirements. Some of the group creativity techniques that can be used are:

- **Brainstorming.** A technique used to generate and collect multiple ideas related to project and product requirements. Although brainstorming by itself does not include voting or prioritization, it is often used with other group creativity techniques that do.
- **Nominal group technique.** A technique that enhances brainstorming with a voting process used to rank the most useful ideas for further brainstorming or for prioritization.
- **Idea/mind mapping.** A technique in which ideas created through individual brainstorming sessions are consolidated into a single map to reflect commonality and differences in understanding, and generate new ideas.
- **Affinity diagram.** A technique that allows large numbers of ideas to be classified into groups for review and analysis.
- **Multicriteria decision analysis.** A technique that utilizes a decision matrix to provide a systematic analytical approach for establishing criteria, such as risk levels, uncertainty, and valuation, to evaluate and rank many ideas.

5.2.2.5 Group Decision-Making Techniques

A group decision-making technique is an assessment process having multiple alternatives with an expected outcome in the form of future actions. These techniques can be used to generate, classify, and prioritize product requirements.

There are various methods of reaching a group decision, such as:

- **Unanimity.** A decision that is reached whereby everyone agrees on a single course of action. One way to reach unanimity is the Delphi technique, in which a selected group of experts answers questionnaires and provides feedback regarding the responses from each round of requirements gathering. The responses are only available to the facilitator to maintain anonymity.
- **Majority.** A decision that is reached with support obtained from more than 50 % of the members of the group. Having a group size with an uneven number of participants can ensure that a decision will be reached, rather than resulting in a tie.
- **Plurality.** A decision that is reached whereby the largest block in a group decides, even if a majority is not achieved. This method is generally used when the number of options nominated is more than two.
- **Dictatorship.** In this method, one individual makes the decision for the group.

All of these group decision-making techniques can be applied to the group creativity techniques used in the Collect Requirements process.

5.2.2.6 Questionnaires and Surveys

Questionnaires and surveys are written sets of questions designed to quickly accumulate information from a large number of respondents. Questionnaires and/or surveys are most appropriate with varied audiences, when a quick turnaround is needed, when respondents are geographically dispersed, and where statistical analysis is appropriate.

5.2.2.7 Observations

Observations provide a direct way of viewing individuals in their environment and how they perform their jobs or tasks and carry out processes. It is particularly helpful for detailed processes when the people that use the product have difficulty or are reluctant to articulate their requirements. Observation is also known as “job shadowing.” It is usually done externally by an observer viewing a business expert performing a job. It can also be done by a “participant observer” who actually performs a process or procedure to experience how it is done to uncover hidden requirements.

5.2.2.8 Prototypes

Prototyping is a method of obtaining early feedback on requirements by providing a working model of the expected product before actually building it. Since a prototype is tangible, it allows stakeholders to experiment with a model of the final product rather than being limited to discussing abstract representations of their requirements. Prototypes support the concept of progressive elaboration in iterative cycles of mock-up creation, user experimentation, feedback generation, and prototype revision. When enough feedback cycles have been performed, the requirements obtained from the prototype are sufficiently complete to move to a design or build phase. Storyboarding is a prototyping technique showing sequence or navigation through a series of images or illustrations. Storyboards are used on a variety of projects in a variety of industries, such as film, advertising, instructional design, and on agile and other software development projects. In software development, storyboards use mock-ups to show navigation paths through webpages, screens, or other user interfaces.

5.2.2.9 Benchmarking

Benchmarking involves comparing actual or planned practices, such as processes and operations, to those of comparable organizations to identify best practices, generate ideas for improvement, and provide a basis for measuring performance. The organizations compared during benchmarking can be internal or external.

5.2.2.10 Context Diagrams

The context diagram is an example of a scope model. Context diagrams visually depict the product scope by showing a business system (process, equipment, computer system, etc.), and how people and other systems (actors) interact with it. Context diagrams show inputs to the business system, the actor(s) providing the input, the outputs from the business system, and the actor(s) receiving the output.

5.2.2.11 Document Analysis

Document analysis is used to elicit requirements by analyzing existing documentation and identifying information relevant to the requirements. There are a wide range of documents that may be analyzed to help elicit relevant requirements. Examples of documents that may be analyzed include, but are not limited to: business plans, marketing literature, agreements, requests for proposal, current process flows, logical data models, business rules repositories, application software documentation, business process or interface documentation, use cases, other requirements documentation, problem/issue logs, policies, procedures, and regulatory documentation such as laws, codes, or ordinances, etc.

5.2.3 Collect Requirements: Outputs

5.2.3.1 Requirements Documentation

Requirements documentation describes how individual requirements meet the business need for the project. Requirements may start out at a high level and become progressively more detailed as more about the requirements is known. Before being baselined, requirements need to be unambiguous (measurable and testable), traceable, complete, consistent, and acceptable to key stakeholders. The format of a requirements document may range from a simple document listing all the requirements categorized by stakeholder and priority, to more elaborate forms containing an executive summary, detailed descriptions, and attachments.

Components of requirements documentation can include, but, are not limited to:

- Business requirements, including:
 - Business and project objectives for traceability;
 - Business rules for the performing organization; and
 - Guiding principles of the organization.

- Stakeholder requirements, including:
 - Impacts to other organizational areas;
 - Impacts to other entities inside or outside the performing organization; and
 - Stakeholder communication and reporting requirements.
- Solution requirements, including:
 - Functional and nonfunctional requirements;
 - Technology and standard compliance requirements;
 - Support and training requirements;
 - Quality requirements; and
 - Reporting requirements, etc. (solution requirements can be documented textually, in models, or both).
- Project requirements, such as:
 - Levels of service, performance, safety, compliance, etc.; and
 - Acceptance criteria.
- Transition requirements.
- Requirements assumptions, dependencies, and constraints.

5.2.3.2 Requirements Traceability Matrix

The requirements traceability matrix is a grid that links product requirements from their origin to the deliverables that satisfy them. The implementation of a requirements traceability matrix helps ensure that each requirement adds business value by linking it to the business and project objectives. It provides a means to track requirements throughout the project life cycle, helping to ensure that requirements approved in the requirements documentation are delivered at the end of the project. Finally, it provides a structure for managing changes to the product scope.

Tracing includes, but is not limited to, tracing requirements for the following:

- Business needs, opportunities, goals, and objectives;
- Project objectives;
- Project scope/WBS deliverables;
- Product design;
- Product development;
- Test strategy and test scenarios; and
- High-level requirements to more detailed requirements.

Attributes associated with each requirement can be recorded in the requirements traceability matrix. These attributes help to define key information about the requirement. Typical attributes used in the requirements traceability matrix may include: a unique identifier, a textual description of the requirement, the rationale for inclusion, owner, source, priority, version, current status (such as active, cancelled, deferred, added, approved, assigned, completed), and status date. Additional attributes to ensure that the requirement has met stakeholders' satisfaction may include stability, complexity, and acceptance criteria. Figure 5-6 provides an example of a requirements traceability matrix with its associated attributes.

Requirements Traceability Matrix								
Project Name:								
Cost Center:								
Project Description:								
ID	Associate ID	Requirements Description	Business Needs, Opportunities, Goals, Objectives	Project Objectives	WBS Deliverables	Product Design	Product Development	Test Cases
001	1.0							
	1.1							
	1.2							
	1.2.1							
002	2.0							
	2.1							
	2.1.1							
003	3.0							
	3.1							
	3.2							
004	4.0							
005	5.0							

Figure 5-6. Example of a Requirements Traceability Matrix

5.3 Define Scope

Define Scope is the process of developing a detailed description of the project and product. The key benefit of this process is that it describes the project, service, or result boundaries by defining which of the requirements collected will be included in and excluded from the project scope. The inputs, tools and techniques, and outputs of this process are depicted in Figure 5-7. Figure 5-8 depicts the data flow diagram of the process.



Figure 5-7. Define Scope: Inputs, Tools & Techniques, and Outputs

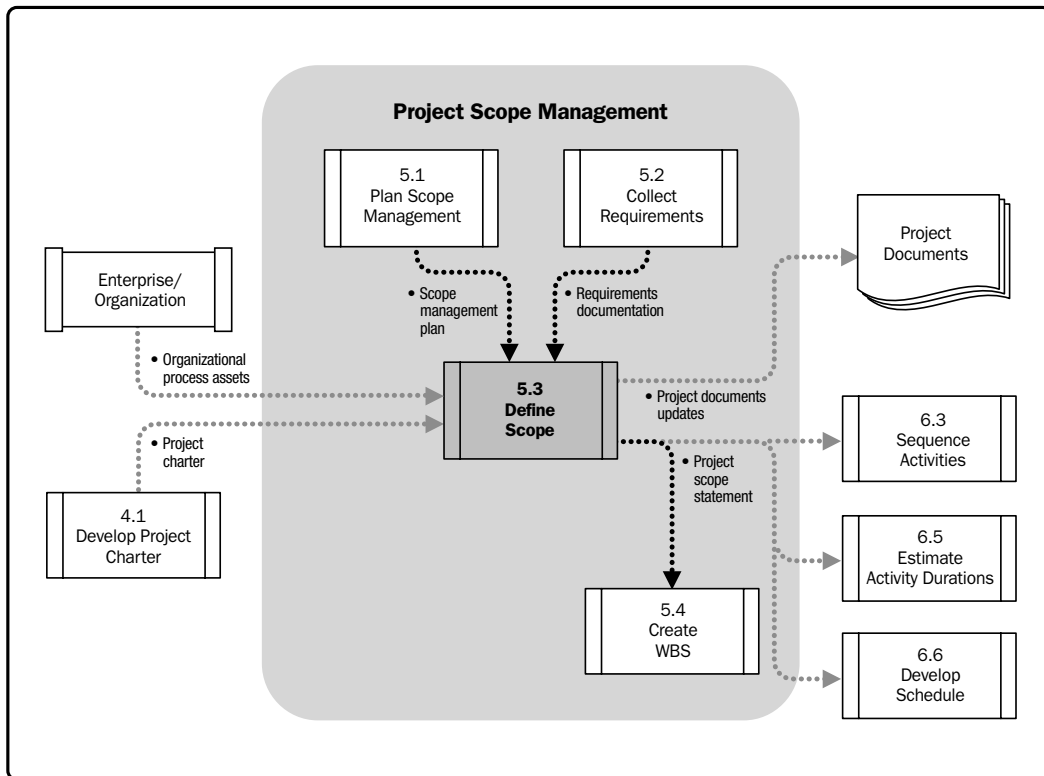

Figure 5-8. Define Scope Data Flow Diagram

Since all of the requirements identified in Collect Requirements may not be included in the project, the Define Scope process selects the final project requirements from the requirements documentation delivered during the Collect Requirements process. It then develops a detailed description of the project and product, service, or result.

The preparation of a detailed project scope statement is critical to project success and builds upon the major deliverables, assumptions, and constraints that are documented during project initiation. During project planning, the project scope is defined and described with greater specificity as more information about the project is known. Existing risks, assumptions, and constraints are analyzed for completeness and added or updated as necessary. The Define Scope process can be highly iterative. In iterative life cycle projects, a high-level vision will be developed for the overall project, but the detailed scope is determined one iteration at a time and the detailed planning for the next iteration is carried out as work progresses on the current project scope and deliverables.

5.3.1 Define Scope: Inputs

5.3.1.1 Scope Management Plan

Described in Section 5.1.3.1. The scope management plan is a component of the project management plan that establishes the activities for developing, monitoring, and controlling the project scope.

5.3.1.2 Project Charter

Described in Section 4.1.3.1. The project charter provides the high-level project description and product characteristics. It also contains project approval requirements. If a project charter is not used in the performing organization, then comparable information needs to be acquired or developed, and used as a basis for the detailed project scope statement. Organizations that do not produce a formal project charter will usually perform an informal analysis to identify the content necessary for further scope planning.

5.3.1.3 Requirements Documentation

Described in Section 5.2.3.1. This documentation will be used to select the requirements that will be included in the project.

5.3.1.4 Organizational Process Assets

Described in Section 2.1.4. Organizational process assets can influence how scope is defined. Examples include, but are not limited to:

- Policies, procedures, and templates for a project scope statement;
- Project files from previous projects; and
- Lessons learned from previous phases or projects.

5.3.2 Define Scope: Tools and Techniques

5.3.2.1 Expert Judgment

Expert judgment is often used to analyze the information needed to develop the project scope statement. Such judgment and expertise is applied to any technical detail. Such expertise is provided by any group or individual with specialized knowledge or training, and is available from many sources, including but not limited to:

- Other units within the organization;
- Consultants;
- Stakeholders, including customers or sponsors;
- Professional and technical associations;
- Industry groups; and
- Subject matter experts.

5.3.2.2 Product Analysis

For projects that have a product as a deliverable, as opposed to a service or result, product analysis can be an effective tool. Each application area has one or more generally accepted methods for translating high-level product descriptions into tangible deliverables. Product analysis includes techniques such as product breakdown, systems analysis, requirements analysis, systems engineering, value engineering, and value analysis.

5.3.2.3 Alternatives Generation

Alternatives generation is a technique used to develop as many potential options as possible in order to identify different approaches to execute and perform the work of the project. A variety of general management techniques can be used, such as brainstorming, lateral thinking, analysis of alternatives, etc.

5.3.2.4 Facilitated Workshops

Described in Section 5.2.2.3. The participation of key players with a variety of expectations and/or fields of expertise in these intensive working sessions helps to reach a cross-functional and common understanding of the project objectives and its limits.

5.3.3 Define Scope: Outputs

5.3.3.1 Project Scope Statement

The project scope statement is the description of the project scope, major deliverables, assumptions, and constraints. The project scope statement documents the entire scope, including project and product scope. It describes, in detail, the project's deliverables and the work required to create those deliverables. It also provides a common understanding of the project scope among project stakeholders. It may contain explicit scope exclusions that can assist in managing stakeholder expectations. It enables the project team to perform more detailed planning, guides the project team's work during execution, and provides the baseline for evaluating whether requests for changes or additional work are contained within or outside the project's boundaries.

The degree and level of detail to which the project scope statement defines the work that will be performed and the work that is excluded can help determine how well the project management team can control the overall project scope. The detailed project scope statement, either directly, or by reference to other documents, includes the following:

- **Product scope description.** Progressively elaborates the characteristics of the product, service, or result described in the project charter and requirements documentation.
- **Acceptance criteria.** A set of conditions that is required to be met before deliverables are accepted.
- **Deliverable.** Any unique and verifiable product, result, or capability to perform a service that is required to be produced to complete a process, phase, or project. Deliverables also include ancillary results, such as project management reports and documentation. These deliverables may be described at a summary level or in great detail.

- **Project exclusion.** Generally identifies what is excluded from the project. Explicitly stating what is out of scope for the project helps to manage stakeholders' expectations.
- **Constraints.** A limiting factor that affects the execution of a project or process. Constraints identified with the project scope statement list and describe the specific internal or external restrictions or limitations associated with the project scope that affect the execution of the project, for example, a predefined budget or any imposed dates or schedule milestones that are issued by the customer or performing organization. When a project is performed under an agreement, contractual provisions will generally be constraints. Information on constraints may be listed in the project scope statement or in a separate log.
- **Assumptions.** A factor in the planning process that is considered to be true, real, or certain, without proof or demonstration. Also describes the potential impact of those factors if they prove to be false. Project teams frequently identify, document, and validate assumptions as part of their planning process. Information on assumptions may be listed in the project scope statement or in a separate log.

Although the project charter and the project scope statement are sometimes perceived as containing a certain degree of redundancy, they are different in the level of detail contained in each. The project charter contains high-level information, while the project scope statement contains a detailed description of the scope elements. These elements are progressively elaborated throughout the project. Table 5-1 describes some of the key elements for each document.

Table 5-1. Elements of the Project Charter and Project Scope Statement

Project Charter	Project Scope Statement
Project purpose or justification	Project scope description (progressively elaborated)
Measurable project objectives and related success criteria	Acceptance criteria
High-level requirements	Project deliverables
High-level project description	Project exclusions
High-level risks	Project constraints
Summary milestone schedule	Project assumptions
Summary budget	
Stakeholder list	
Project approval requirements (what constitutes success, who decides it, who signs off)	
Assigned project manager, responsibility, and authority level	
Name and authority of the sponsor or other person(s) authorizing the project charter	

5.3.3.2 Project Documents Updates

Project documents that may be updated include, but are not limited to:

- Stakeholder register,
- Requirements documentation, and
- Requirements traceability matrix.

5.4 Create WBS

Create WBS is the process of subdividing project deliverables and project work into smaller, more manageable components. The key benefit of this process is that it provides a structured vision of what has to be delivered. The inputs, tools and techniques, and outputs of this process are depicted in Figure 5-9. Figure 5-10 depicts the data flow diagram of the process.

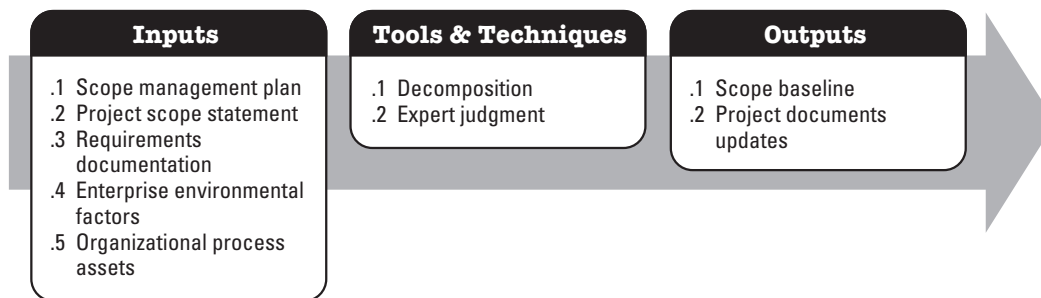

Figure 5-9. Create WBS: Inputs, Tools & Techniques, and Outputs

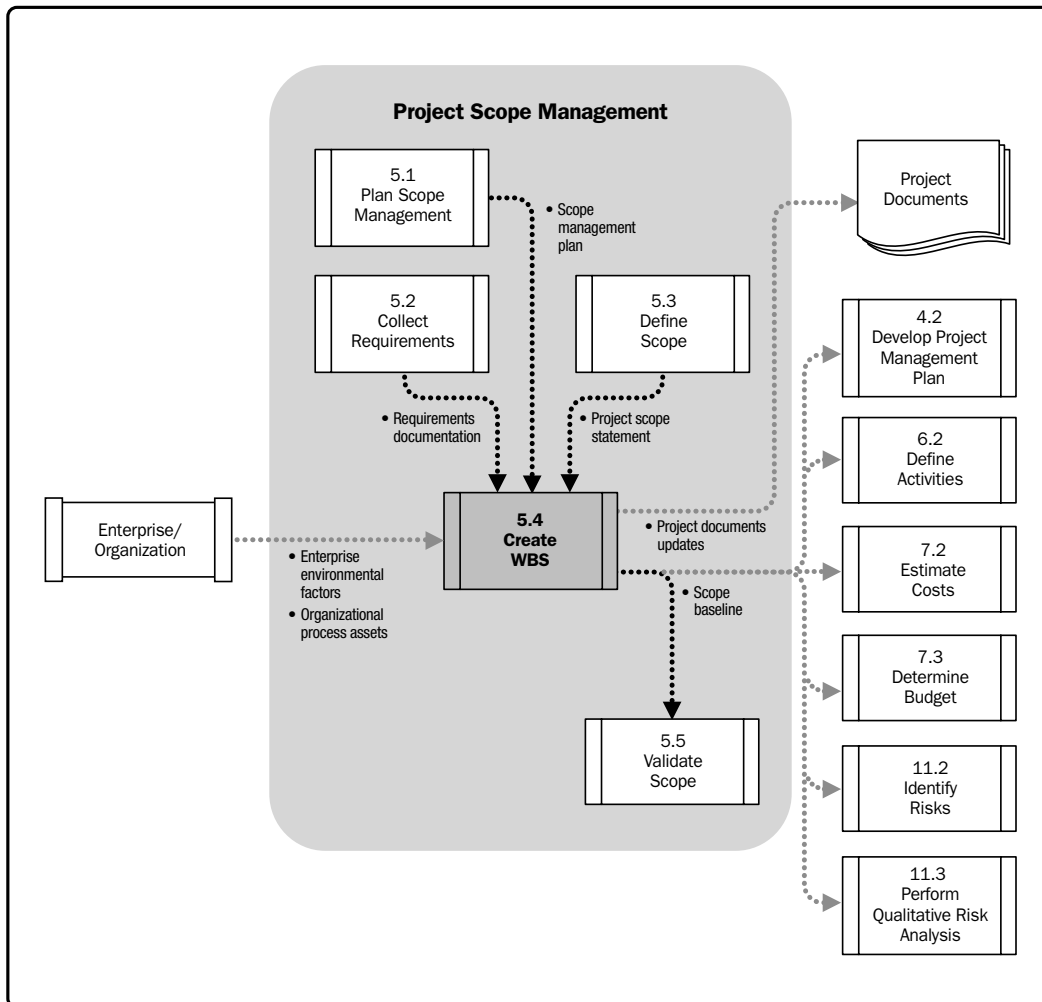

Figure 5-10. Create WBS Data Flow Diagram

The WBS is a hierarchical decomposition of the total scope of work to be carried out by the project team to accomplish the project objectives and create the required deliverables. The WBS organizes and defines the total scope of the project, and represents the work specified in the current approved project scope statement.

The planned work is contained within the lowest level of WBS components, which are called work packages. A work package can be used to group the activities where work is scheduled and estimated, monitored, and controlled. In the context of the WBS, work refers to work products or deliverables that are the result of activity and not to the activity itself.

5.4.1 Create WBS: Inputs

5.4.1.1 Scope Management Plan

Described in Section 5.1.3.1. The scope management plan specifies how to create the WBS from the detailed project scope statement and how the WBS will be maintained and approved.

5.4.1.2 Project Scope Statement

Described in Section 5.3.3.1. The project scope statement describes the work that will be performed and the work that is excluded. It also lists and describes the specific internal or external restrictions or limitations that may affect the execution of the project.

5.4.1.3 Requirements Documentation

Described in Section 5.2.3.1. Detailed requirements documentation is essential for understanding what needs to be produced as the result of the project and what needs to be done to deliver the project and its final products.

5.4.1.4 Enterprise Environmental Factors

Described in Section 2.1.5. Industry-specific WBS standards, relevant to the nature of the project, may serve as external reference sources for creation of the WBS. For example, engineering projects may reference ISO/IEC 15288 on Systems Engineering – System Life Cycle Processes [6], to create a WBS for a new project.

5.4.1.5 Organizational Process Assets

Described in Section 2.1.4. The organizational process assets that can influence the Create WBS process include, but are not limited to:

- Policies, procedures, and templates for the WBS;
- Project files from previous projects; and
- Lessons learned from previous projects.

5.4.2 Create WBS: Tools and Techniques

5.4.2.1 Decomposition

Decomposition is a technique used for dividing and subdividing the project scope and project deliverables into smaller, more manageable parts. The work package is the work defined at the lowest level of the WBS for which cost and duration can be estimated and managed. The level of decomposition is often guided by the degree of control needed to effectively manage the project. The level of detail for work packages will vary with the size and complexity of the project. Decomposition of the total project work into work packages generally involves the following activities:

- Identifying and analyzing the deliverables and related work;
- Structuring and organizing the WBS;
- Decomposing the upper WBS levels into lower-level detailed components;
- Developing and assigning identification codes to the WBS components; and
- Verifying that the degree of decomposition of the deliverables is appropriate.

A portion of a WBS with some branches of the WBS decomposed down through the work package level is shown in Figure 5-11.

5.4.2.2 Expert Judgment

Expert judgment is often used to analyze the information needed to decompose the project deliverables down into smaller component parts in order to create an effective WBS. Such judgment and expertise is applied to technical details of the project's scope and used to reconcile differences in opinion on how to best break down the overall scope of the project. This level of expertise is provided by any group or individual with relevant training, knowledge, or experience with similar projects or business areas. Expert judgment can also come in the form of predefined templates that provide guidance on how to effectively break down common deliverables. Such templates may be industry or discipline specific or may come from experience gained in similar projects. The project manager, in collaboration with the project team, then determines the final decomposition of the project scope into the discrete work packages that will be used to effectively manage the work of the project.

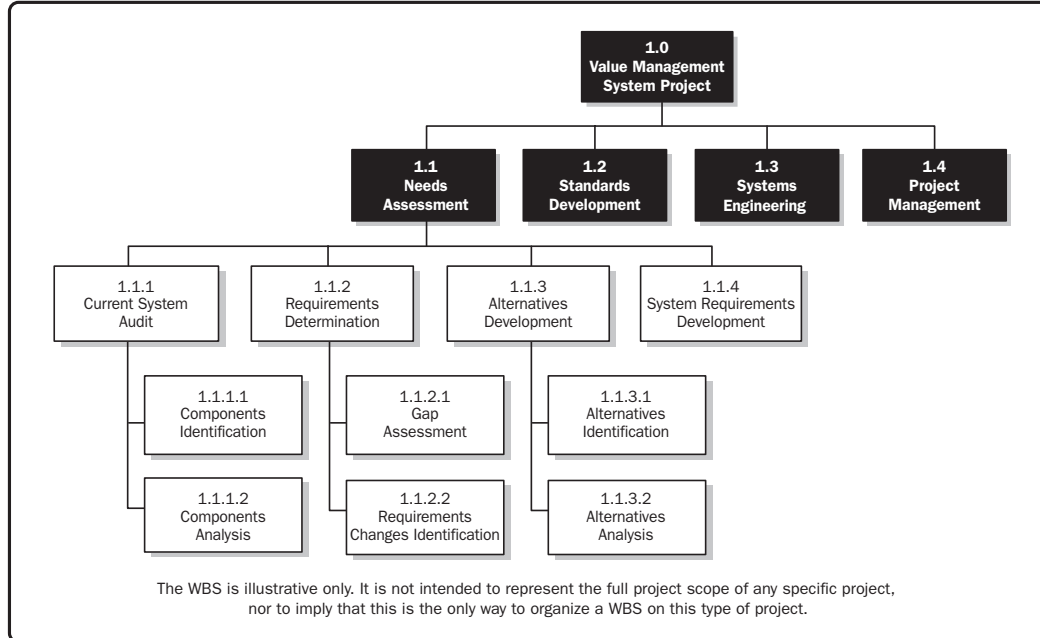

Figure 5-11. Sample WBS Decomposed Down Through Work Packages

A WBS structure may be created through various approaches. Some of the popular methods include the top-down approach, the use of organization-specific guidelines, and the use of WBS templates. A bottom-up approach can be used during the integration of subcomponents. The WBS structure can be represented in a number of forms, such as:

- Using phases of the project life cycle as the second level of decomposition, with the product and project deliverables inserted at the third level, as shown in Figure 5-12;
- Using major deliverables as the second level of decomposition, as shown in Figure 5-13; and
- Incorporating subcomponents which may be developed by organizations outside the project team, such as contracted work. The seller then develops the supporting contract WBS as part of the contracted work.

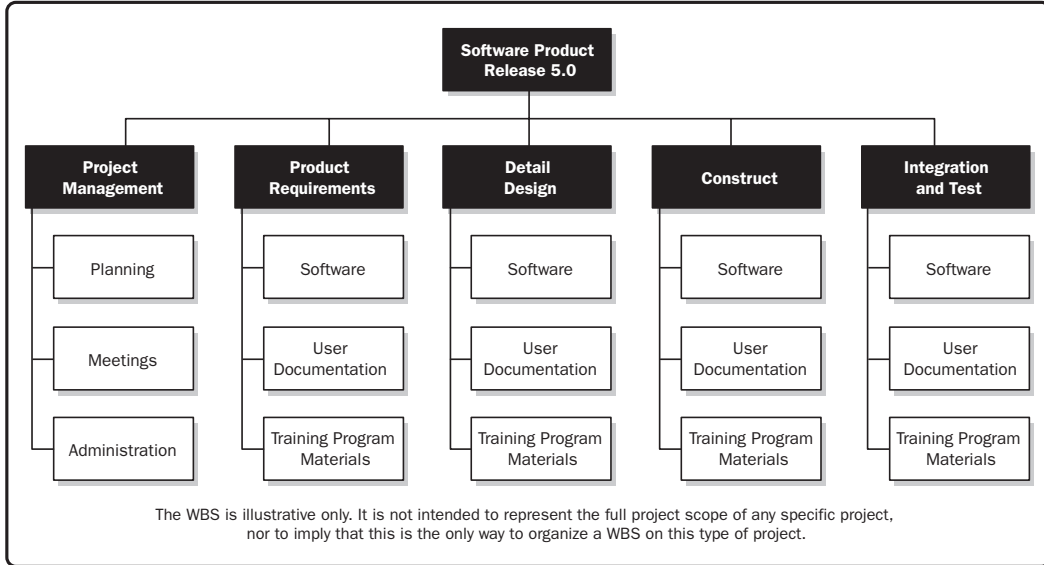

Figure 5-12. Sample WBS Organized by Phase

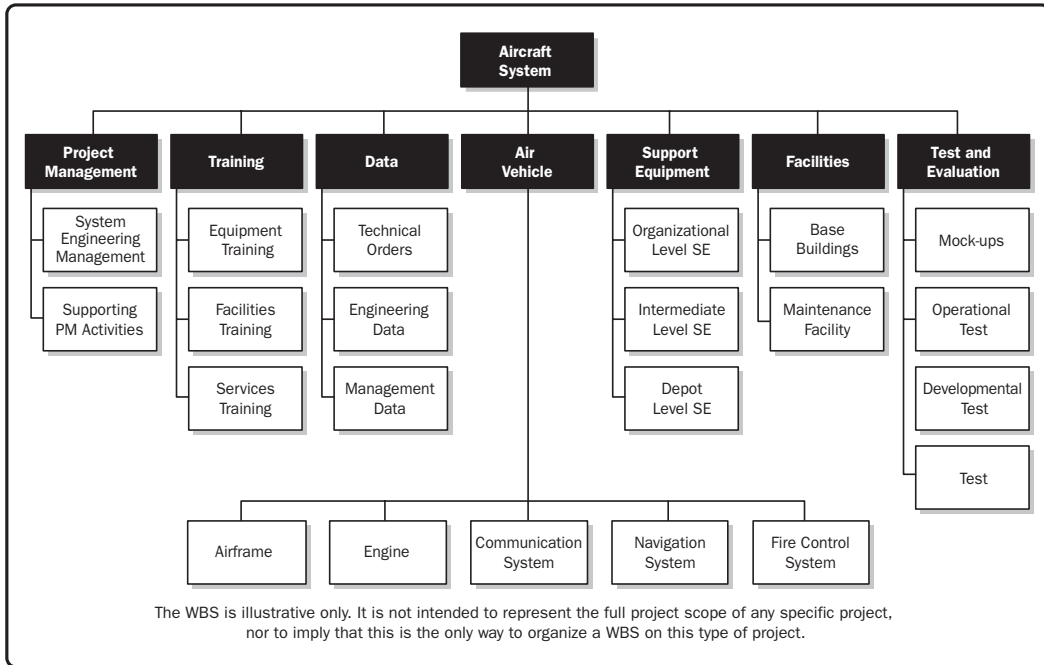

Figure 5-13. Sample WBS with Major Deliverables

Decomposition of the upper-level WBS components requires subdividing the work for each of the deliverables or subcomponents into its most fundamental elements, where the WBS components represent verifiable products, services, or results. The WBS may be structured as an outline, an organizational chart, or other method that identifies a hierarchical breakdown. Verifying the correctness of the decomposition requires determining that the lower-level WBS components are those that are necessary and sufficient for completion of the corresponding higher-level deliverables. Different deliverables can have different levels of decomposition. To arrive at a work package, the work for some deliverables needs to be decomposed only to the next level, while others need additional levels of decomposition. As the work is decomposed to greater levels of detail, the ability to plan, manage, and control the work is enhanced. However, excessive decomposition can lead to nonproductive management effort, inefficient use of resources, decreased efficiency in performing the work, and difficulty aggregating data over different levels of the WBS.

Decomposition may not be possible for a deliverable or subcomponent that will be accomplished far into the future. The project management team usually waits until the deliverable or subcomponent is agreed on, so the details of the WBS can be developed. This technique is sometimes referred to as rolling wave planning.

The WBS represents all product and project work, including the project management work. The total of the work at the lowest levels should roll up to the higher levels so that nothing is left out and no extra work is performed. This is sometimes called the 100 percent rule.

For specific information regarding the WBS, refer to the *Practice Standard for Work Breakdown Structures – Second Edition* [7]. This standard contains industry-specific examples of WBS templates that can be tailored to specific projects in a particular application area.

5.4.3 Create WBS: Outputs

5.4.3.1 Scope Baseline

The scope baseline is the approved version of a scope statement, work breakdown structure (WBS), and its associated WBS dictionary, that can be changed only through formal change control procedures and is used as a basis for comparison. It is a component of the project management plan. Components of the scope baseline include:

- **Project scope statement.** The project scope statement includes the description of the project scope, major deliverables, assumptions, and constraints.

- **WBS.** The WBS is a hierarchical decomposition of the total scope of work to be carried out by the project team to accomplish the project objectives and create the required deliverables. Each descending level of the WBS represents an increasingly detailed definition of the project work. The WBS is finalized by assigning each work package to a control account and establishing a unique identifier for that work package from a code of accounts. These identifiers provide a structure for hierarchical summation of costs, schedule, and resource information. A control account is a management control point where scope, budget, actual cost, and schedule are integrated and compared to the earned value for performance measurement. Control accounts are placed at selected management points in the WBS. Each control account may include one or more work packages, but each of the work packages should be associated with only one control account. A control account may include one or more planning packages. A planning package is a work breakdown structure component below the control account with known work content but without detailed schedule activities.
- **WBS dictionary.** The WBS dictionary is a document that provides detailed deliverable, activity, and scheduling information about each component in the WBS. The WBS dictionary is a document that supports the WBS. Information in the WBS dictionary may include, but is not limited to:
 - Code of account identifier,
 - Description of work,
 - Assumptions and constraints,
 - Responsible organization,
 - Schedule milestones,
 - Associated schedule activities,
 - Resources required,
 - Cost estimates,
 - Quality requirements,
 - Acceptance criteria,
 - Technical references, and
 - Agreement information.

5.4.3.2 Project Documents Updates

Project documents that may be updated include, but are not limited to, requirements documentation, which may need to be updated to include approved changes. If approved change requests result from the Create WBS process, then the requirements documentation may need to be updated to include approved changes.

5.5 Validate Scope

Validate Scope is the process of formalizing acceptance of the completed project deliverables. The key benefit of this process is that it brings objectivity to the acceptance process and increases the chance of final product, service, or result acceptance by validating each deliverable. The inputs, tools and techniques, and outputs of this process are depicted in Figure 5-14. Figure 5-15 depicts the data flow diagram of the process.

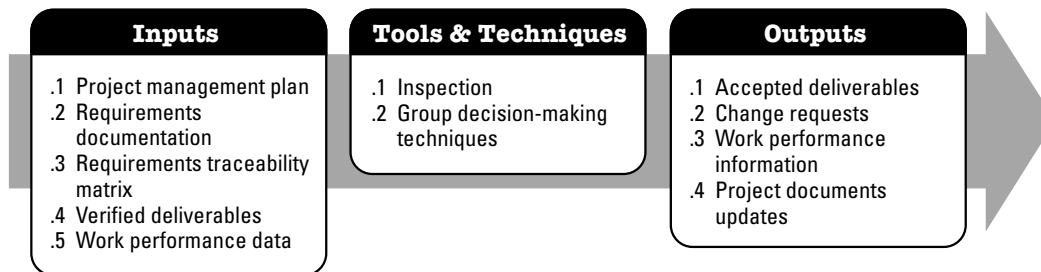

Figure 5-14. Validate Scope: Inputs, Tools & Techniques, and Outputs

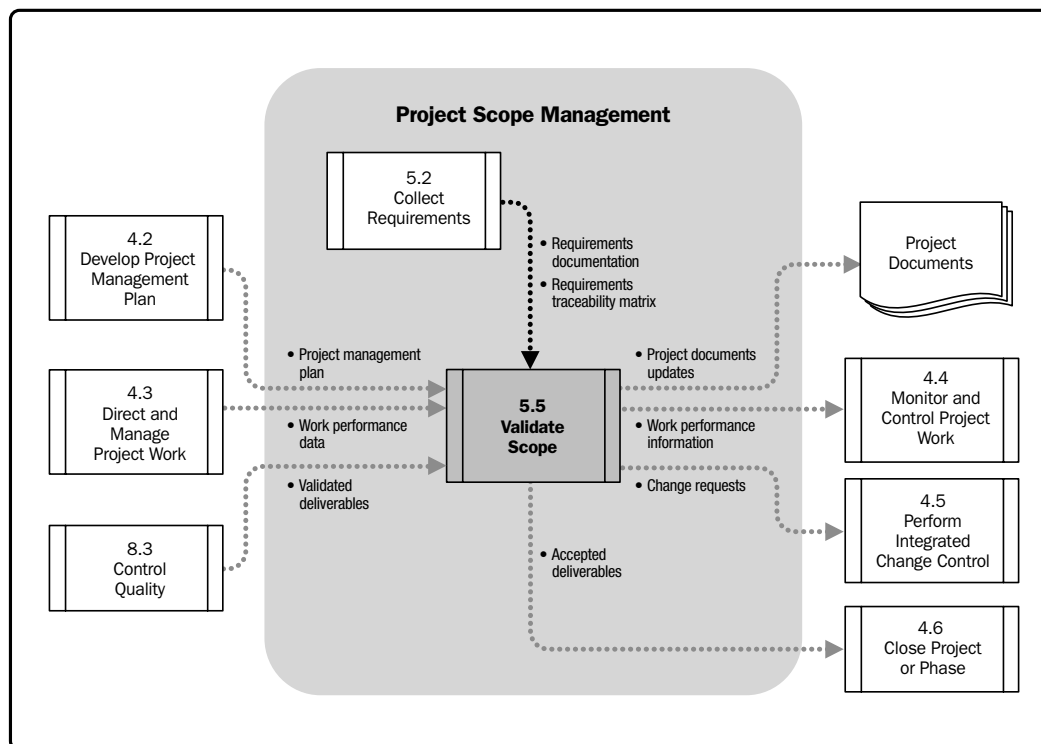

Figure 5-15. Validate Scope Data Flow Diagram

The verified deliverables obtained from the Control Quality process are reviewed with the customer or sponsor to ensure that they are completed satisfactorily and have received formal acceptance of the deliverables by the customer or sponsor. In this process, the outputs obtained as a result of the Planning processes in the Project Scope Management Knowledge Area, such as the requirements documentation or the scope baseline, as well as the work performance data obtained from the Execution processes in other Knowledge Areas, are the basis for performing the validation and for final acceptance.

The Validate Scope process differs from the Control Quality process in that the former is primarily concerned with acceptance of the deliverables, while quality control is primarily concerned with correctness of the deliverables and meeting the quality requirements specified for the deliverables. Control Quality is generally performed before Validate Scope, although the two processes may be performed in parallel.

5.5.1 Validate Scope: Inputs

5.5.1.1 Project Management Plan

Described in Section 4.2.3.1. The project management plan contains the scope management plan and the scope baseline. As described in Section 5.1.3.1, the scope management plan specifies how formal acceptance of the completed project deliverables will be obtained. The scope baseline (Section 5.4.3.1) includes the approved version of a scope statement, work breakdown structure (WBS), and its associated WBS dictionary, that can be changed only through formal change control procedures and is used as a basis for comparison.

5.5.1.2 Requirements Documentation

Described in Section 5.2.3.1. The requirements documentation lists all the project, product, and other types of requirements for the project and product, along with their acceptance criteria.

5.5.1.3 Requirements Traceability Matrix

Described in Section 5.2.3.2. The requirements traceability matrix links requirements to their origin and tracks them throughout the project life cycle.

5.5.1.4 Verified Deliverables

Described in Section 8.3.3.3. Verified deliverables are project deliverables that are completed and checked for correctness through the Control Quality process.

5.5.1.5 Work Performance Data

Described in Section 4.3.3.2. Work performance data can include the degree of compliance with requirements, number of nonconformities, severity of the nonconformities, or the number of validation cycles performed in a period of time.

5.5.2 Validate Scope: Tools and Techniques

5.5.2.1 Inspection

Inspection includes activities such as measuring, examining, and validating to determine whether work and deliverables meet requirements and product acceptance criteria. Inspections are sometimes called reviews, product reviews, audits, and walkthroughs. In some application areas, these different terms have unique and specific meanings.

5.5.2.2 Group Decision-Making Techniques

Described in Section 5.2.2.5. These techniques are used to reach a conclusion when the validation is performed by the project team and other stakeholders.

5.5.3 Validate Scope: Outputs

5.5.3.1 Accepted Deliverables

Deliverables that meet the acceptance criteria are formally signed off and approved by the customer or sponsor. Formal documentation received from the customer or sponsor acknowledging formal stakeholder acceptance of the project's deliverables is forwarded to the Close Project or Phase process (Section 4.6).

5.5.3.2 Change Requests

The completed deliverables that have not been formally accepted are documented, along with the reasons for nonacceptance of those deliverables. Those deliverables may require a change request for defect repair. The change requests are processed for review and disposition through the Perform Integrated Change Control process (Section 4.5).

5.5.3.3 Work Performance Information

Work performance information includes information about project progress, such as which deliverables have started, their progress, which deliverables have finished, or which have been accepted. This information is documented as described in Section 10.3.3.1 and communicated to stakeholders.

5.5.3.4 Project Documents Updates

Project documents that may be updated as a result of the Validate Scope process include any documents that define the product or report status on product completion. Verified project documents may require approvals from the customer or sponsor in the form of signatures or signoffs.

5.6 Control Scope

Control Scope is the process of monitoring the status of the project and product scope and managing changes to the scope baseline. The key benefit of this process is that it allows the scope baseline to be maintained throughout the project. The inputs, tools and techniques, and outputs of this process are depicted in Figure 5-16. Figure 5-17 depicts the data flow diagram of the process.

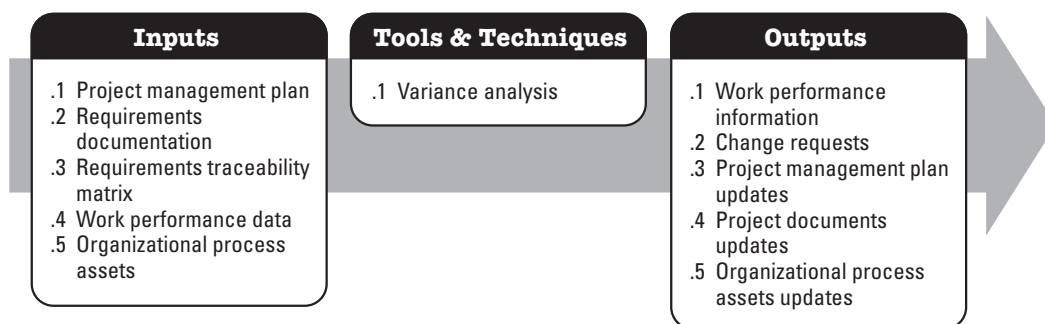

Figure 5-16. Control Scope: Inputs, Tools & Techniques, and Outputs

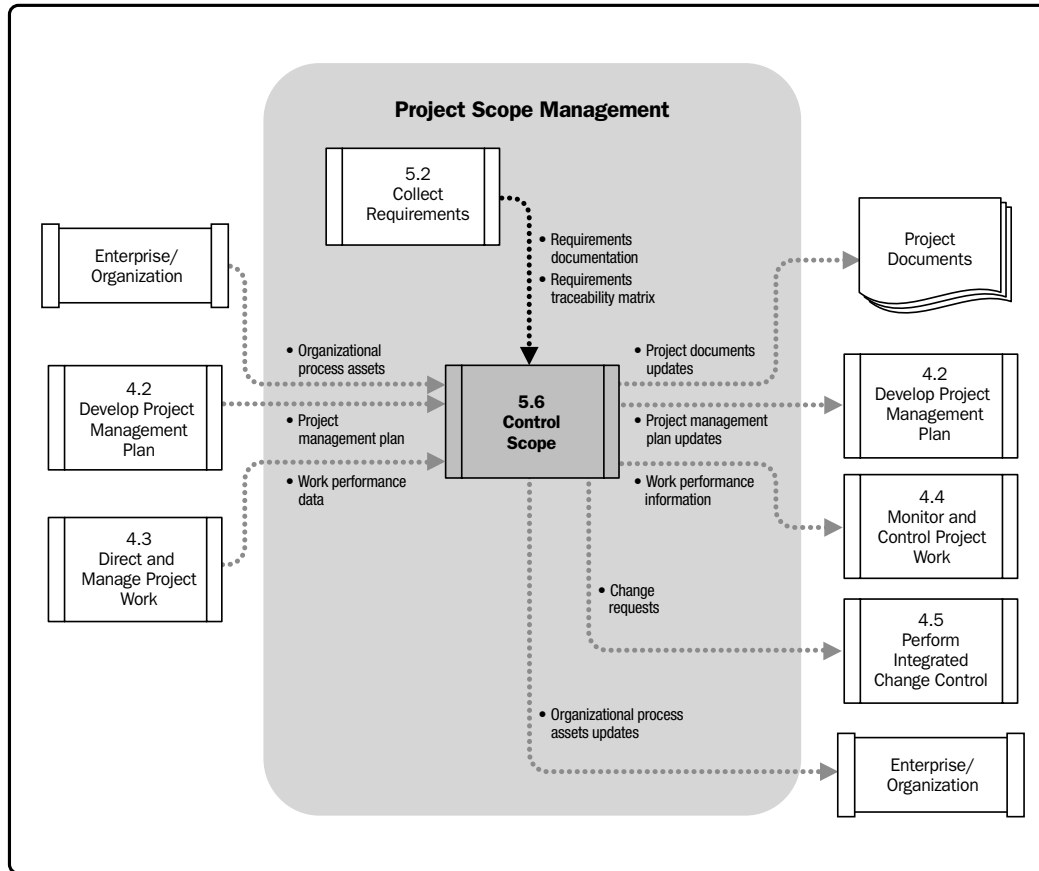

Figure 5-17. Control Scope Data Flow Diagram

Controlling the project scope ensures all requested changes and recommended corrective or preventive actions are processed through the Perform Integrated Change Control process (see Section 4.5). Control Scope is also used to manage the actual changes when they occur and is integrated with the other control processes. The uncontrolled expansion to product or project scope without adjustments to time, cost, and resources is referred to as scope creep. Change is inevitable; therefore some type of change control process is mandatory for every project.

5.6.1 Control Scope: Inputs

5.6.1.1 Project Management Plan

Described in Section 4.2.3.1. The following information from the project management plan is used to control scope:

- **Scope baseline.** The scope baseline is compared to actual results to determine if a change, corrective action, or preventive action is necessary.
- **Scope management plan.** Sections from the scope management plan describe how the project scope will be monitored and controlled.
- **Change management plan.** The change management plan defines the process for managing change on the project.
- **Configuration management plan.** The configuration management plan defines those items that are configurable, those items that require formal change control, and the process for controlling changes to such items.
- **Requirements management plan.** This plan is a component of the project management plan and describes how the project requirements will be analyzed, documented, and managed.

5.6.1.2 Requirements Documentation

Described in Section 5.2.3.1. Requirements should be unambiguous (measurable and testable), traceable, complete, consistent, and acceptable to key stakeholders. Well-documented requirements make it easier to detect any deviation in the scope agreed for the project or product.

5.6.1.3 Requirements Traceability Matrix

Described in Section 5.2.3.2. The requirements traceability matrix helps to detect the impact of any change or deviation from the scope baseline on the project objectives.

5.6.1.4 Work Performance Data

Described in Section 4.3.3.2. Work performance data can include the number of change requests received, the number of requests accepted or the number of deliverables completed, etc.

5.6.1.5 Organizational Process Assets

Described in Section 2.1.4. The organizational process assets that can influence the Control Scope process include, but are not limited to:

- Existing formal and informal scope, control-related policies, procedures, guidelines; and
- Monitoring and reporting methods and templates to be used.

5.6.2 Control Scope: Tools and Techniques

5.6.2.1 Variance Analysis

Variance analysis is a technique for determining the cause and degree of difference between the baseline and actual performance. Project performance measurements are used to assess the magnitude of variation from the original scope baseline. Important aspects of project scope control include determining the cause and degree of variance relative to the scope baseline (Section 5.4.3.1) and deciding whether corrective or preventive action is required.

5.6.3 Control Scope: Outputs

5.6.3.1 Work Performance Information

Work performance information produced includes correlated and contextualized information on how the project scope is performing compared to the scope baseline. It can include the categories of the changes received, the identified scope variances and their causes, how they impact schedule or cost, and the forecast of the future scope performance. This information provides a foundation for making scope decisions.

5.6.3.2 Change Requests

Analysis of scope performance can result in a change request to the scope baseline or other components of the project management plan. Change requests can include preventive or corrective actions, defect repairs, or enhancement requests. Change requests are processed for review and disposition according to the Perform Integrated Change Control process (Section 4.5).

5.6.3.3 Project Management Plan Updates

Project management plan updates may include, but are not limited to:

- **Scope Baseline Updates.** If the approved change requests have an effect on the project scope, then the scope statement, the WBS, and the WBS dictionary are revised and reissued to reflect the approved changes through Perform Integrated Change Control process.
- **Other Baseline Updates.** If the approved change requests have an effect on the project besides the project scope, then the corresponding cost baseline and schedule baselines are revised and reissued to reflect the approved changes.

5.6.3.4 Project Documents Updates

Project documents that may be updated include, but are not limited to:

- Requirements documentation, and
- Requirements traceability matrix.

5.6.3.5 Organizational Process Assets Updates

Organizational process assets that may be updated include, but are not limited to:

- Causes of variances,
- Corrective action chosen and the reasons, and
- Other types of lessons learned from project scope control.

6

PROJECT TIME MANAGEMENT

Project Time Management includes the processes required to manage the timely completion of the project.

Figure 6-1 provides an overview of the Project Time Management processes, which are as follows:

- 6.1 Plan Schedule Management**—The process of establishing the policies, procedures, and documentation for planning, developing, managing, executing, and controlling the project schedule.
- 6.2 Define Activities**—The process of identifying and documenting the specific actions to be performed to produce the project deliverables.
- 6.3 Sequence Activities**—The process of identifying and documenting relationships among the project activities.
- 6.4 Estimate Activity Resources**—The process of estimating the type and quantities of material, human resources, equipment, or supplies required to perform each activity.
- 6.5 Estimate Activity Durations**—The process of estimating the number of work periods needed to complete individual activities with estimated resources.
- 6.6 Develop Schedule**—The process of analyzing activity sequences, durations, resource requirements, and schedule constraints to create the project schedule model.
- 6.7 Control Schedule**—The process of monitoring the status of project activities to update project progress and manage changes to the schedule baseline to achieve the plan.

These processes interact with each other and with processes in other Knowledge Areas as described in detail in Section 3 and Annex A1.

Distinguishing the project schedule presentation (schedule) from the schedule data (Section 6.6.3.3) and calculations that produce the project schedule (Section 6.6.3.2) is practiced by referring to the scheduling tool populated with project data as the schedule model. A schedule model is a representation of the plan for executing the project's activities including durations, dependencies, and other planning information, used to produce project schedules along with other scheduling artifacts. For specific information regarding the schedule model, refer to the *Practice Standard for Scheduling*. [8]

On some projects, especially those of smaller scope, defining activities, sequencing activities, estimating activity resources, estimating activity durations, and developing the schedule model are so tightly linked that they are viewed as a single process that can be performed by a person over a relatively short period of time. These processes are presented here as distinct elements because the tools and techniques for each process are different.

The Project Time Management processes and their associated tools and techniques are documented in the schedule management plan. The schedule management plan is a subsidiary plan of, and integrated with, the project management plan through the Develop Project Management Plan process (Section 4.2). The schedule management plan identifies a scheduling method and scheduling tool (Figure 6-2), and sets the format and establishes criteria for developing and controlling the project schedule. The selected scheduling method defines the framework and algorithms used in the scheduling tool to create the schedule model. Some of the better known scheduling methods include critical path method (CPM) and critical chain method (CCM).

Project schedule development uses the outputs from the processes to define activities, sequence activities, estimate activity resources, and estimate activity durations in combination with the scheduling tool to produce the schedule model. The finalized and approved schedule is the baseline that will be used in the Control Schedule process (Section 6.7). As the project activities are being performed, the majority of effort in the Project Time Management Knowledge Area will occur in the Control Schedule process to ensure completion of project work in a timely manner. Figure 6-2 provides a scheduling overview that shows how the scheduling method, scheduling tool, and outputs from the Project Time Management processes interact to create a project schedule.

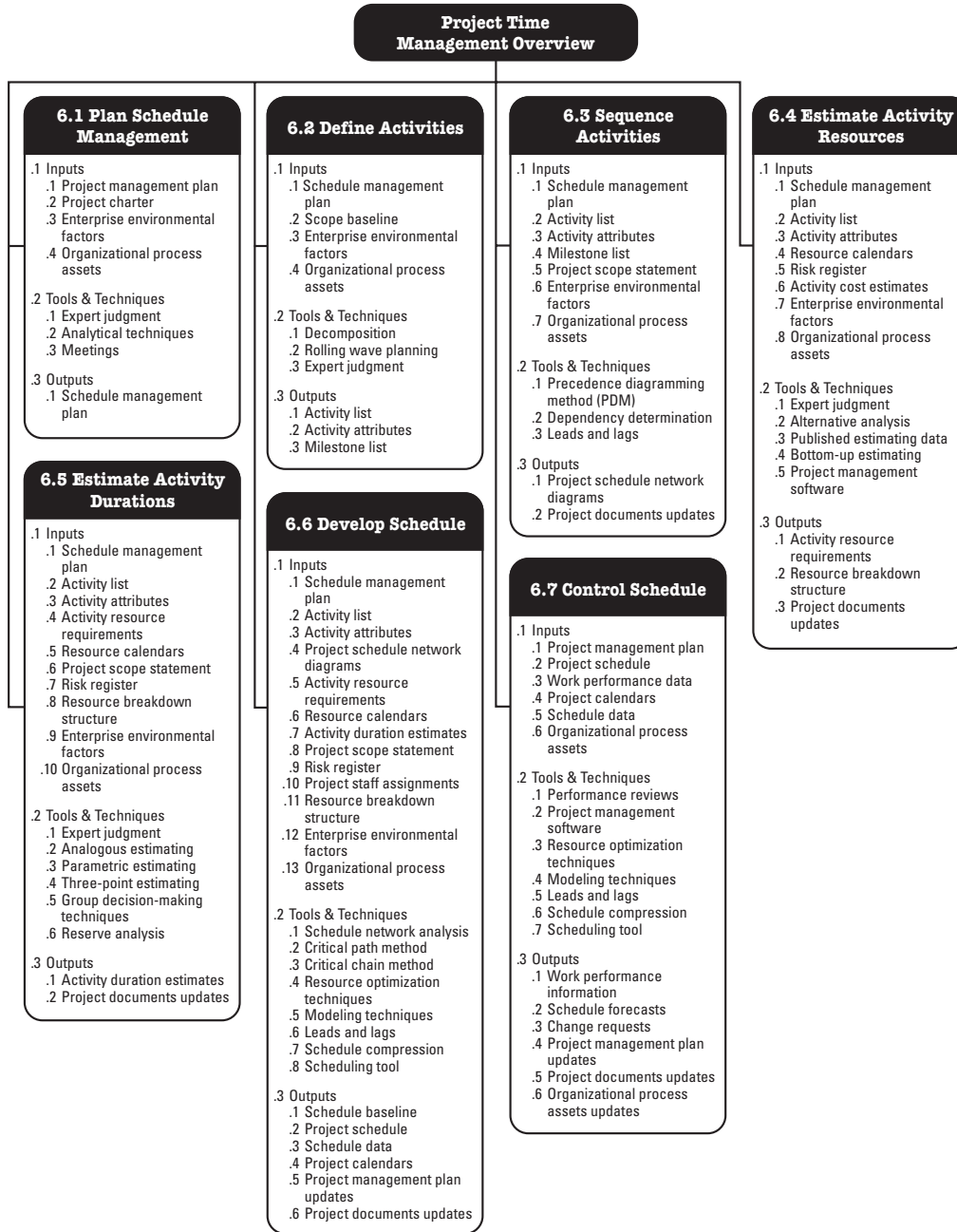

Figure 6-1. Project Time Management Overview

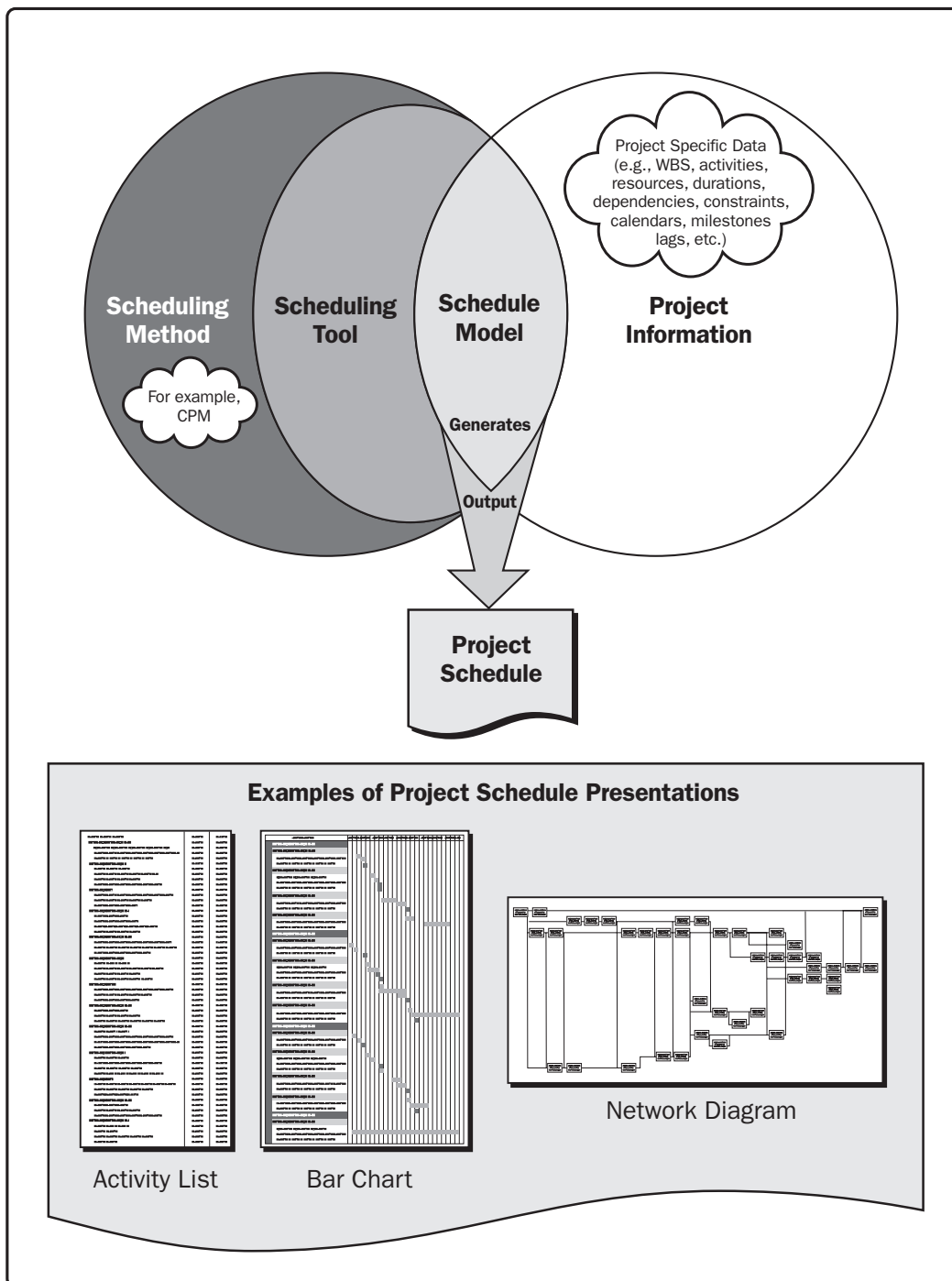

Figure 6-2. Scheduling Overview

6.1 Plan Schedule Management

Plan Schedule Management is the process of establishing the policies, procedures, and documentation for planning, developing, managing, executing, and controlling the project schedule. The key benefit of this process is that it provides guidance and direction on how the project schedule will be managed throughout the project. The inputs, tools and techniques, and outputs of this process are depicted in Figure 6-3. Figure 6-4 depicts the data flow diagram of the process.

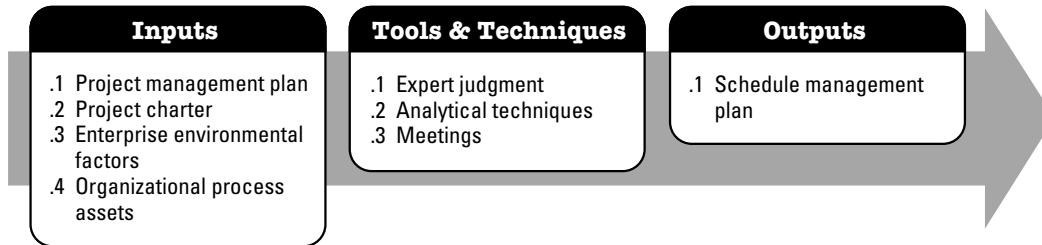

Figure 6-3. Plan Schedule Management: Inputs, Tools & Techniques, and Outputs

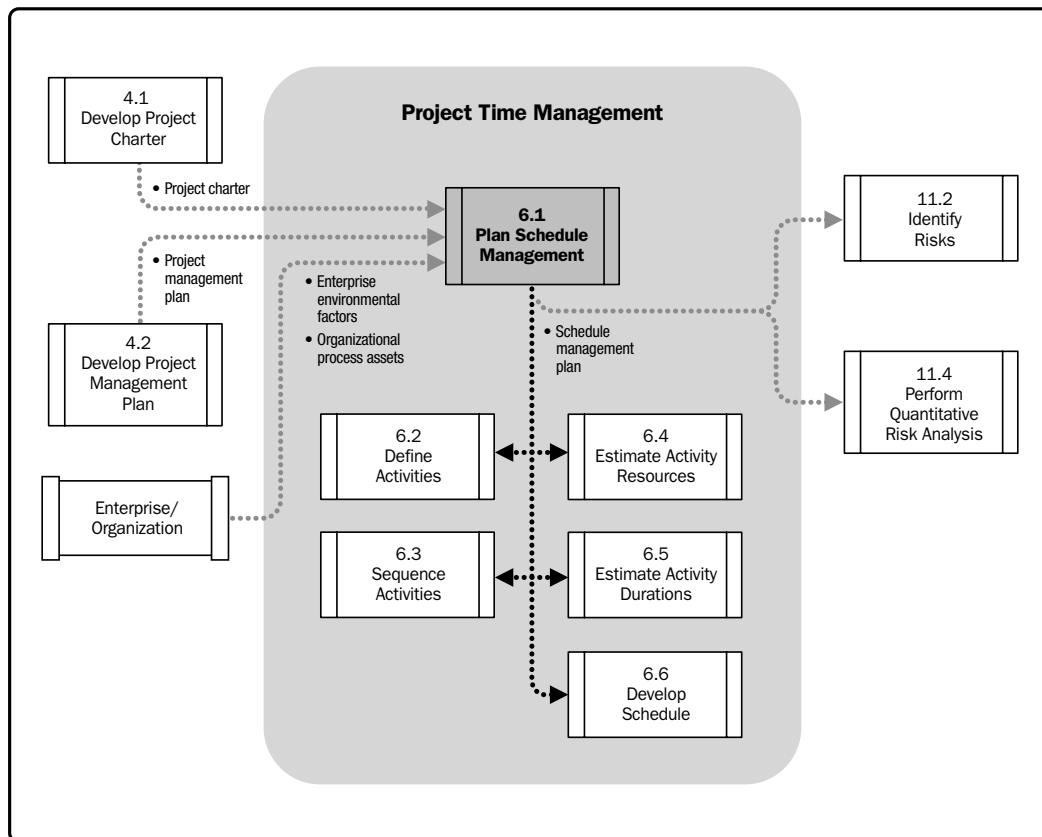

Figure 6-4. Plan Schedule Management Data Flow Diagram

The schedule management plan is a component of the project management plan. The schedule management plan may be formal or informal, highly detailed or broadly framed, based upon the needs of the project, and includes appropriate control thresholds. The schedule management plan defines how schedule contingencies will be reported and assessed. The schedule management plan may be updated to reflect a change in the way the schedule is managed. The schedule management plan is a major input into the Develop Project Management Plan process, as referenced in Section 6.1.3.1.

6.1.1 Plan Schedule Management: Inputs

6.1.1.1 Project Management Plan

Described in Section 4.2.3.1. The project management plan contains information used to develop the schedule management plan which includes, but is not limited to:

- **Scope baseline.** The scope baseline includes the project scope statement and the work breakdown structure (WBS) details used for defining activities, duration estimation, and schedule management; and
- **Other information.** Other scheduling related cost, risk, and communications decisions from the project management plan are used to develop the schedule.

6.1.1.2 Project Charter

Described in Section 4.1.3.1. The project charter defines the summary milestone schedule and project approval requirements that will influence the management of the project schedule.

6.1.1.3 Enterprise Environmental Factors

Described in Section 2.1.5. The enterprise environmental factors that influence the Plan Schedule Management process include, but are not limited to:

- Organizational culture and structure can all influence schedule management;
- Resource availability and skills that may influence schedule planning;
- Project management software provides the scheduling tool and alternative possibilities for managing the schedule;
- Published commercial information, such as resource productivity information, is often available from commercial databases that track; and
- Organizational work authorization systems.

6.1.1.4 Organizational Process Assets

Described in Section 2.1.4. The organizational process assets that influence the Plan Schedule Management process include, but are not limited to:

- Monitoring and reporting tools to be used;
- Historical information;
- Schedule control tools;
- Existing formal and informal schedule control related policies, procedures, and guidelines;
- Templates;
- Project closure guidelines;
- Change control procedures; and
- Risk control procedures including risk categories, probability definition and impact, and probability and impact matrix.

6.1.2 Plan Schedule Management: Tools and Techniques

6.1.2.1 Expert Judgment

Expert judgment, guided by historical information, provides valuable insight about the environment and information from prior similar projects. Expert judgment can also suggest whether to combine methods and how to reconcile differences between them.

Judgment based upon expertise in an application area, Knowledge Area, discipline, industry, etc., as appropriate for the activity being performed, should be used in developing the schedule management plan.

6.1.2.2 Analytical Techniques

The Plan Schedule Management process may involve choosing strategic options to estimate and schedule the project such as: scheduling methodology, scheduling tools and techniques, estimating approaches, formats, and project management software. The schedule management plan may also detail ways to fast track or crash (Section 6.6.2.7) the project schedule such as undertaking work in parallel. These decisions, like other schedule decisions affecting the project, may affect project risks.

Organizational policies and procedures may influence which scheduling techniques are employed in these decisions. Techniques may include, but are not limited to, rolling wave planning (Section 6.2.2.2), leads and lags (Section 6.3.2.3), alternatives analysis (Section 6.4.2.2), and methods for reviewing schedule performance (Section 6.7.2.1).

6.1.2.3 Meetings

Project teams may hold planning meetings to develop the schedule management plan. Participants at these meetings may include the project manager, the project sponsor, selected project team members, selected stakeholders, anyone with responsibility for schedule planning or execution, and others as needed.

6.1.3 Plan Schedule Management: Outputs

6.1.3.1 Schedule Management Plan

A component of the project management plan that establishes the criteria and the activities for developing, monitoring, and controlling the schedule. The schedule management plan may be formal or informal, highly detailed or broadly framed, based upon the needs of the project, and includes appropriate control thresholds.

For example, the schedule management plan can establish the following:

- **Project schedule model development.** The scheduling methodology and the scheduling tool to be used in the development of the project schedule model are specified.
- **Level of accuracy.** The acceptable range used in determining realistic activity duration estimates is specified and may include an amount for contingencies.
- **Units of measure.** Each unit used in measurements (such as staff hours, staff days, or weeks for time measures, or meters, liters, tons, kilometers, or cubic yards for quantity measures) is defined for each of the resources.
- **Organizational procedures links.** The WBS (Section 5.4) provides the framework for the schedule management plan, allowing for consistency with the estimates and resulting schedules.
- **Project schedule model maintenance.** The process used to update the status and record progress of the project in the schedule model during the execution of the project is defined.
- **Control thresholds.** Variance thresholds for monitoring schedule performance may be specified to indicate an agreed-upon amount of variation to be allowed before some action needs to be taken. Thresholds are typically expressed as percentage deviations from the parameters established in the baseline plan.

- **Rules of performance measurement.** Earned value management (EVM) rules or other physical measurement rules of performance measurement are set. For example, the schedule management plan may specify:
 - Rules for establishing percent complete,
 - Control accounts at which management of progress and schedule will be measured,
 - Earned value measurement techniques (e.g., baselines, fixed-formula, percent complete, etc.) to be employed (for more specific information, refer to the *Practice Standard for Earned Value Management*) [9],
 - Schedule performance measurements such as schedule variance (SV) and schedule performance index (SPI) used to assess the magnitude of variation to the original schedule baseline.
- **Reporting formats.** The formats and frequency for the various schedule reports are defined.
- **Process descriptions.** Descriptions of each of the schedule management processes are documented.

6.2 Define Activities

Define Activities is the process of identifying and documenting the specific actions to be performed to produce the project deliverables. The key benefit of this process is to break down work packages into activities that provide a basis for estimating, scheduling, executing, monitoring, and controlling the project work. The inputs, tools and techniques, and outputs of this process are depicted in Figure 6-5. Figure 6-6 depicts the data flow diagram of the process.

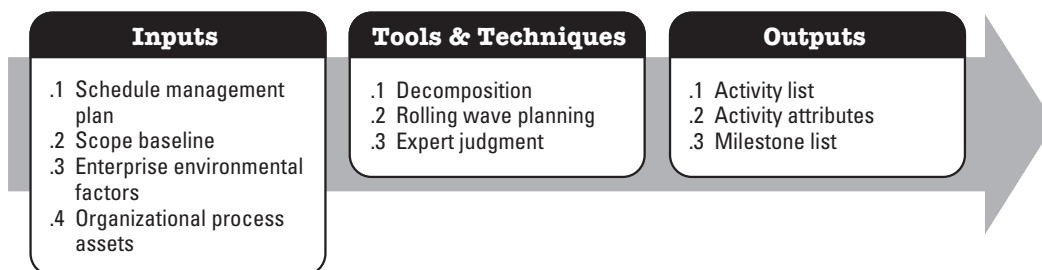

Figure 6-5. Define Activities: Inputs, Tools & Techniques, and Outputs

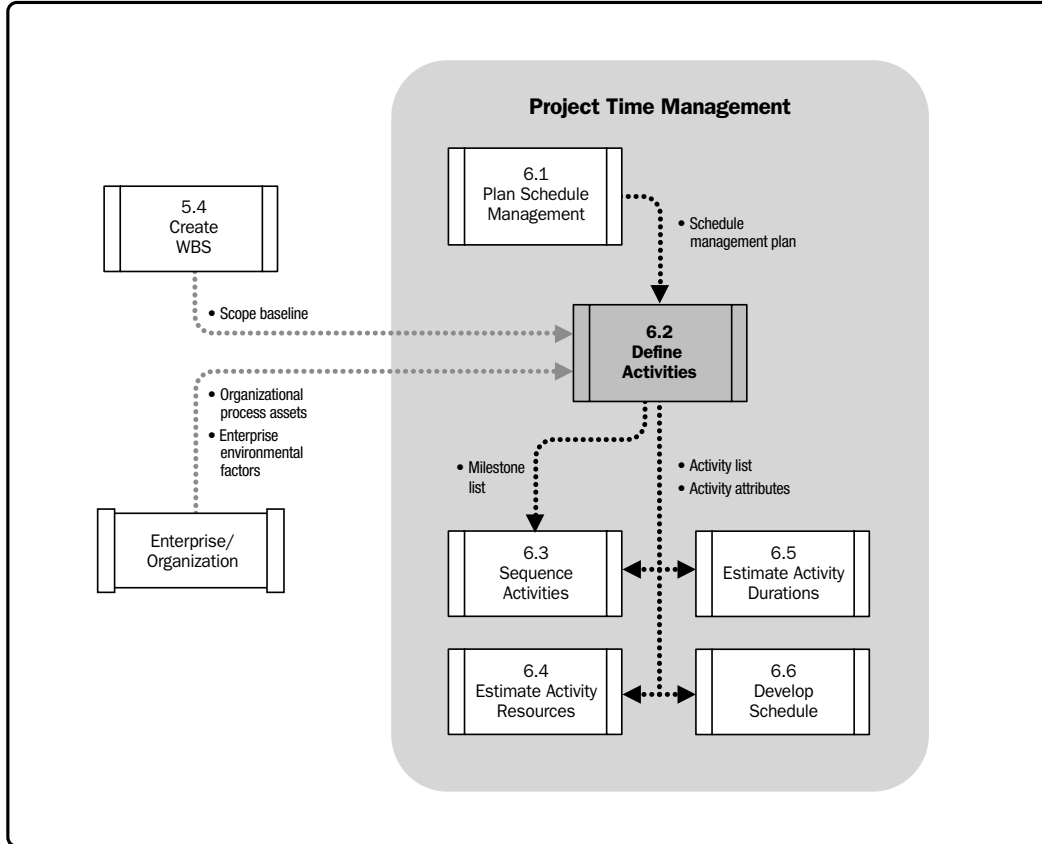

Figure 6-6. Define Activities Data Flow Diagram

Implicit in this process are defining and planning the schedule activities such that the project objectives will be met. The Create WBS process identifies the deliverables at the lowest level in the WBS—the work package. Work packages are typically decomposed into smaller components called activities that represent the work effort required to complete the work package.

6.2.1 Define Activities: Inputs

6.2.1.1 Schedule Management Plan

Described in Section 6.1.3.1. A key input from the schedule management plan is the prescribed level of detail necessary to manage the work.

6.2.1.2 Scope Baseline

Described in Section 5.4.3.1. The project WBS, deliverables, constraints, and assumptions documented in the scope baseline are considered explicitly while defining activities.

6.2.1.3 Enterprise Environmental Factors

Described in Section 2.1.5. Enterprise environmental factors that influence the Define Activities process include, but are not limited to:

- Organizational cultures and structure,
- Published commercial information from commercial databases, and
- Project management information system (PMIS).

6.2.1.4 Organizational Process Assets

Described in Section 2.1.4. The organizational process assets that can influence the Define Activities process include, but are not limited to:

- Lessons learned knowledge base containing historical information regarding activity lists used by previous similar projects,
- Standardized processes,
- Templates that contain a standard activity list or a portion of an activity list from a previous project, and
- Existing formal and informal activity planning-related policies, procedures, and guidelines, such as the scheduling methodology, that are considered in developing the activity definitions.

6.2.2 Define Activities: Tools and Techniques

6.2.2.1 Decomposition

Decomposition is a technique used for dividing and subdividing the project scope and project deliverables into smaller, more manageable parts. Activities represent the effort needed to complete a work package. The Define Activities process defines the final outputs as activities rather than deliverables, as done in the Create WBS process (Section 5.4).

The activity list, WBS, and WBS dictionary can be developed either sequentially or concurrently, with the WBS and WBS dictionary as the basis for development of the final activity list. Each work package within the WBS is decomposed into the activities required to produce the work package deliverables. Involving team members in the decomposition can lead to better and more accurate results.

6.2.2.2 Rolling Wave Planning

Rolling wave planning is an iterative planning technique in which the work to be accomplished in the near term is planned in detail, while the work in the future is planned at a higher level. It is a form of progressive elaboration. Therefore, work can exist at various levels of detail depending on where it is in the project life cycle. During early strategic planning, when information is less defined, work packages may be decomposed to the known level of detail. As more is known about the upcoming events in the near term, work packages can be decomposed into activities.

6.2.2.3 Expert Judgment

Project team members or other experts, who are experienced and skilled in developing detailed project scope statements, the WBS, and project schedules, can provide expertise in defining activities.

6.2.3 Define Activities: Outputs

6.2.3.1 Activity List

The activity list is a comprehensive list that includes all schedule activities required on the project. The activity list also includes the activity identifier and a scope of work description for each activity in sufficient detail to ensure that project team members understand what work is required to be completed. Each activity should have a unique title that describes its place in the schedule, even if that activity title is displayed outside the context of the project schedule.

6.2.3.2 Activity Attributes

Activities, distinct from milestones, have durations, during which the work of that activity is performed, and may have resources and costs associated with that work. Activity attributes extend the description of the activity by identifying the multiple components associated with each activity. The components for each activity evolve over time. During the initial stages of the project, they include the activity identifier (ID), WBS ID, and activity label or name, and when completed, may include activity codes, activity description, predecessor activities, successor activities, logical relationships, leads and lags (Section 6.3.2.3), resource requirements, imposed dates, constraints, and assumptions. Activity attributes can be used to identify the person responsible for executing the work, geographic area, or place where the work has to be performed, the project calendar the activity is assigned to, and activity type such as level of effort (often abbreviated as LOE), discrete effort, and apportioned effort. Activity attributes are used for schedule development and for selecting, ordering, and sorting the planned schedule activities in various ways within reports. The number of attributes varies by application area.

6.2.3.3 Milestone List

A milestone is a significant point or event in a project. A milestone list is a list identifying all project milestones and indicates whether the milestone is mandatory, such as those required by contract, or optional, such as those based upon historical information. Milestones are similar to regular schedule activities, with the same structure and attributes, but they have zero duration because milestones represent a moment in time.

6.3 Sequence Activities

Sequence Activities is the process of identifying and documenting relationships among the project activities. The key benefit of this process is that it defines the logical sequence of work to obtain the greatest efficiency given all project constraints. The inputs, tools and techniques, and outputs of this process are depicted in Figure 6-7. Figure 6-8 depicts the data flow diagram of the process.

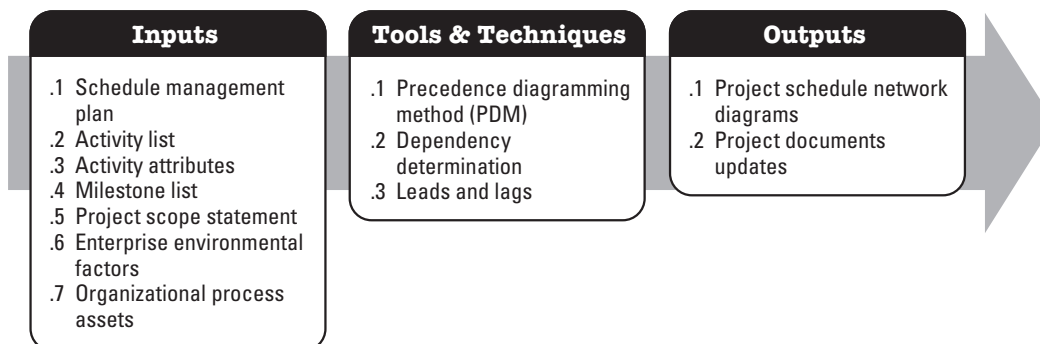

Figure 6-7. Sequence Activities: Inputs, Tools & Techniques, and Outputs

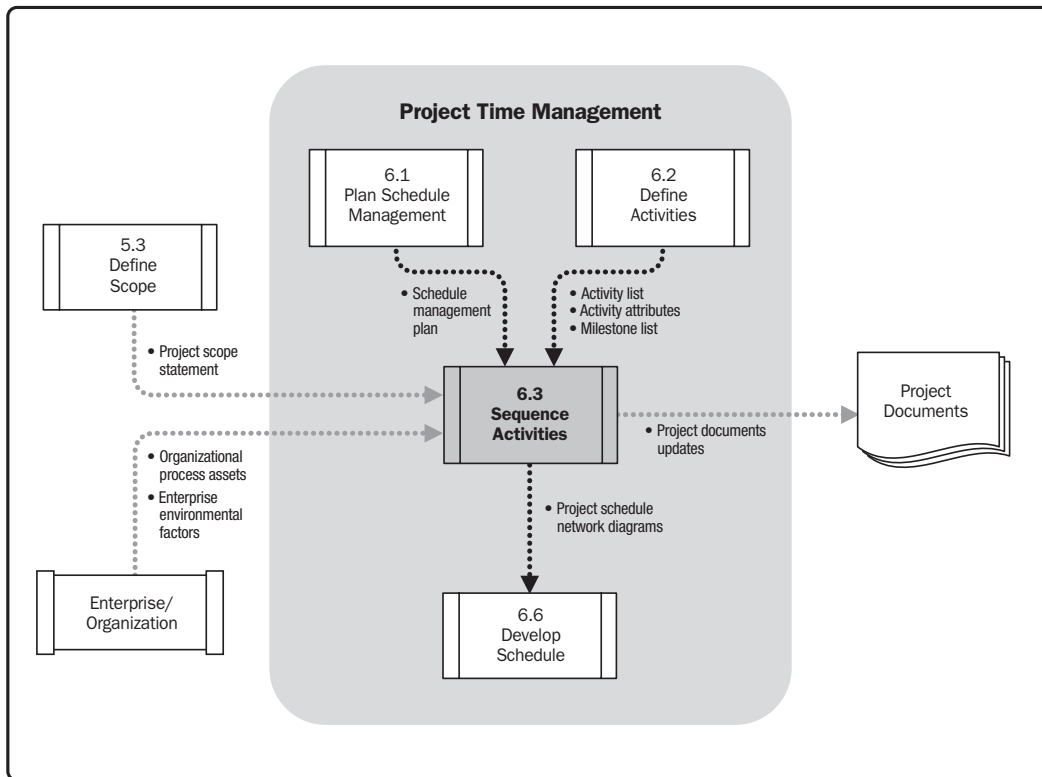

Figure 6-8. Sequence Activities Data Flow Diagram

Every activity and milestone except the first and last should be connected to at least one predecessor with a finish-to-start or start-to-start logical relationship and at least one successor with a finish-to-start or finish-to-finish logical relationship. Logical relationships should be designed to create a realistic project schedule. It may be necessary to use lead or lag time between activities to support a realistic and achievable project schedule. Sequencing can be performed by using project management software or by using manual or automated techniques.

6.3.1 Sequence Activities: Inputs

6.3.1.1 Schedule Management Plan

Described in Section 6.1.3.1. The schedule management plan identifies the scheduling method and tool to be used for the project, which will guide how the activities may be sequenced.

6.3.1.2 Activity List

Described in Section 6.2.3.1. The activity list contains all schedule activities required on the project, which are to be sequenced. Dependencies and other constraints for these activities can influence the sequencing of the activities.

6.3.1.3 Activity Attributes

Described in Section 6.2.3.2. Activity attributes may describe a necessary sequence of events or defined predecessor or successor relationships.

6.3.1.4 Milestone List

Described in Section 6.2.3.3. The milestone list may have scheduled dates for specific milestones, which may influence the way activities are sequenced.

6.3.1.5 Project Scope Statement

Described in Section 5.3.3.1. The project scope statement contains the product scope description, which includes product characteristics that may affect activity sequencing, such as the physical layout of a plant to be constructed or subsystem interfaces on a software project. Other information from the project scope statement including project deliverables, project constraints, and project assumptions may also affect activity sequencing. While these effects are often apparent in the activity list, the product scope description is generally reviewed to ensure accuracy.

6.3.1.6 Enterprise Environmental Factors

Described in Section 2.1.5. Enterprise environmental factors that influence the Sequence Activities process include, but are not limited to:

- Government or industry standards,
- Project management information system (PMIS),
- Scheduling tool, and
- Company work authorization systems.

6.3.1.7 Organizational Process Assets

Described in Section 2.1.4. The organizational process assets that can influence the Sequence Activities process include, but are not limited to: project files from the corporate knowledge base used for scheduling methodology, existing formal and informal activity planning-related policies, procedures, and guidelines, such as the scheduling methodology that are considered in developing logical relationships, and templates that can be used to expedite the preparation of networks of project activities. Related activity attributes information in templates can also contain additional descriptive information useful in sequencing activities.

6.3.2 Sequence Activities: Tools and Techniques

6.3.2.1 Precedence Diagramming Method

The precedence diagramming method (PDM) is a technique used for constructing a schedule model in which activities are represented by nodes and are graphically linked by one or more logical relationships to show the sequence in which the activities are to be performed. Activity-on-node (AON) is one method of representing a precedence diagram. This is the method used by most project management software packages.

PDM includes four types of dependencies or logical relationships. A predecessor activity is an activity that logically comes before a dependent activity in a schedule. A successor activity is a dependent activity that logically comes after another activity in a schedule. These relationships are defined below and are illustrated in Figure 6-9:

- **Finish-to-start (FS).** A logical relationship in which a successor activity cannot start until a predecessor activity has finished. Example: The awards ceremony (successor) cannot start until the race (predecessor) has finished.
- **Finish-to-finish (FF).** A logical relationship in which a successor activity cannot finish until a predecessor activity has finished. Example: Writing a document (predecessor) is required to finish before editing the document (successor) can finish.
- **Start-to-start (SS).** A logical relationship in which a successor activity cannot start until a predecessor activity has started. Example: Level concrete (successor) cannot begin until pour foundation (predecessor) begins.
- **Start-to-finish (SF).** A logical relationship in which a successor activity cannot finish until a predecessor activity has started. Example: The first security guard shift (successor) cannot finish until the second security guard shift (predecessor) starts.

In PDM, finish-to-start is the most commonly used type of precedence relationship. The start-to-finish relationship is very rarely used but is included to present a complete list of the PDM relationship types.

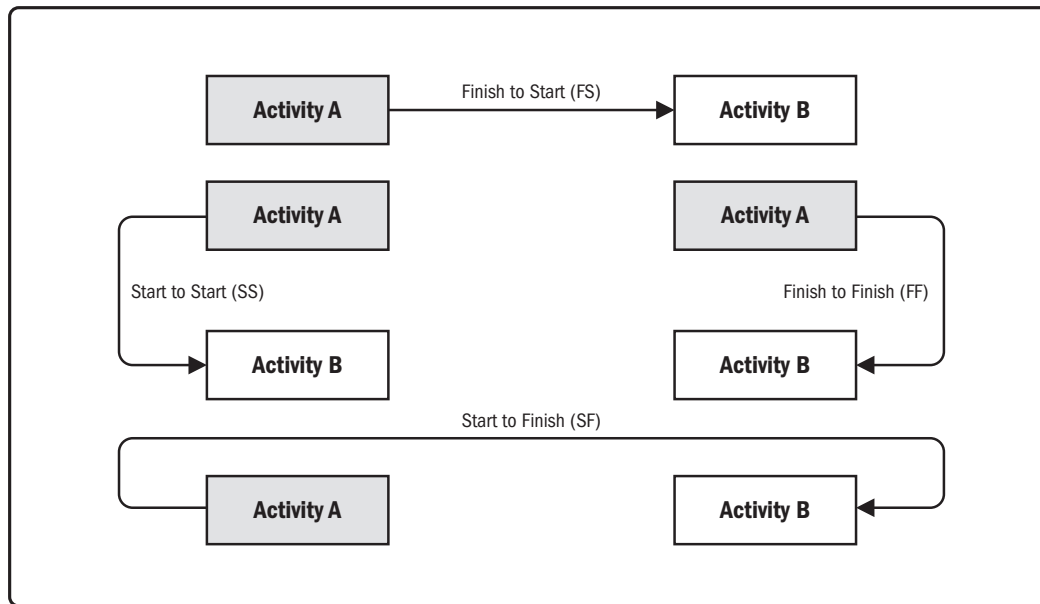

Figure 6-9. Precedence Diagramming Method (PDM) Relationship Types

6.3.2.2 Dependency Determination

Dependencies may be characterized by the following attributes: mandatory or discretionary, internal or external, as described below. Dependency has four attributes, but two can be applicable at the same time in following ways: mandatory external dependencies, mandatory internal dependencies, discretionary external dependencies, or discretionary internal dependencies.

- Mandatory dependencies.** Mandatory dependencies are those that are legally or contractually required or inherent in the nature of the work. Mandatory dependencies often involve physical limitations, such as on a construction project, where it is impossible to erect the superstructure until after the foundation has been built, or on an electronics project, where a prototype has to be built before it can be tested. Mandatory dependencies are also sometimes referred to as hard logic or hard dependencies. Technical dependencies may not be mandatory. The project team determines which dependencies are mandatory during the process of sequencing the activities. Mandatory dependencies should not be confused with assigning schedule constraints in the scheduling tool.

- **Discretionary dependencies.** Discretionary dependencies are sometimes referred to as preferred logic, preferential logic, or soft logic. Discretionary dependencies are established based on knowledge of best practices within a particular application area or some unusual aspect of the project where a specific sequence is desired, even though there may be other acceptable sequences. Discretionary dependencies should be fully documented since they can create arbitrary total float values and can limit later scheduling options. When fast tracking techniques are employed, these discretionary dependencies should be reviewed and considered for modification or removal. The project team determines which dependencies are discretionary during the process of sequencing the activities.
- **External dependencies.** External dependencies involve a relationship between project activities and non-project activities. These dependencies are usually outside the project team's control. For example, the testing activity in a software project may be dependent on the delivery of hardware from an external source, or governmental environmental hearings may need to be held before site preparation can begin on a construction project. The project management team determines which dependencies are external during the process of sequencing the activities.
- **Internal dependencies.** Internal dependencies involve a precedence relationship between project activities and are generally inside the project team's control. For example, if the team cannot test a machine until they assemble it, this is an internal mandatory dependency. The project management team determines which dependencies are internal during the process of sequencing the activities.

6.3.2.3 Leads and Lags

A lead is the amount of time whereby a successor activity can be advanced with respect to a predecessor activity. For example, on a project to construct a new office building, the landscaping could be scheduled to start two weeks prior to the scheduled punch list completion. This would be shown as a finish-to-start with a two-week lead as shown in Figure 6-10. Lead is often represented as a negative value for lag in scheduling software.

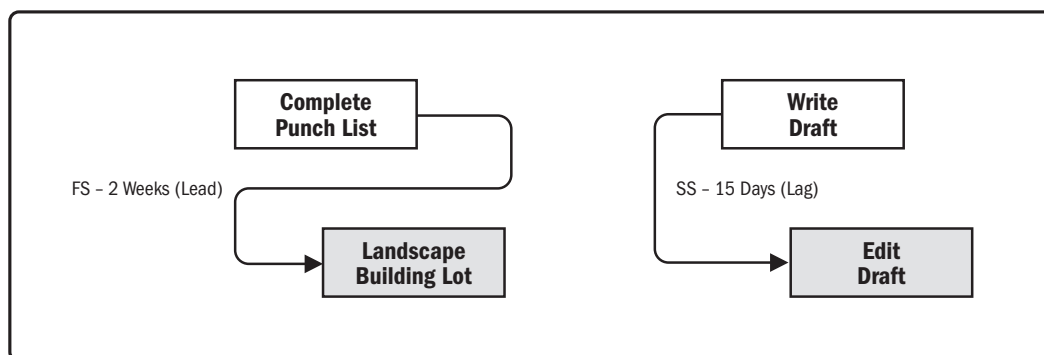

Figure 6-10. Examples of Lead and Lag

A lag is the amount of time whereby a successor activity will be delayed with respect to a predecessor activity. For example, a technical writing team may begin editing the draft of a large document 15 days after they begin writing it. This can be shown as a start-to-start relationship with a 15-day lag as shown in Figure 6-10. Lag can also be represented in project schedule network diagrams as shown in Figure 6-11 in the relationship between activities H and I, as indicated by the nomenclature SS+10 (start-to-start plus 10 days lag) even though offset is not shown relative to a timescale.

The project management team determines the dependencies that may require a lead or a lag to accurately define the logical relationship. The use of leads and lags should not replace schedule logic. Activities and their related assumptions should be documented.

6.3.3 Sequence Activities: Outputs

6.3.3.1 Project Schedule Network Diagrams

A project schedule network diagram is a graphical representation of the logical relationships, also referred to as dependencies, among the project schedule activities. Figure 6-11 illustrates a project schedule network diagram. A project schedule network diagram is produced manually or by using project management software. It can include full project details, or have one or more summary activities. A summary narrative can accompany the diagram and describe the basic approach used to sequence the activities. Any unusual activity sequences within the network should be fully described within the narrative.

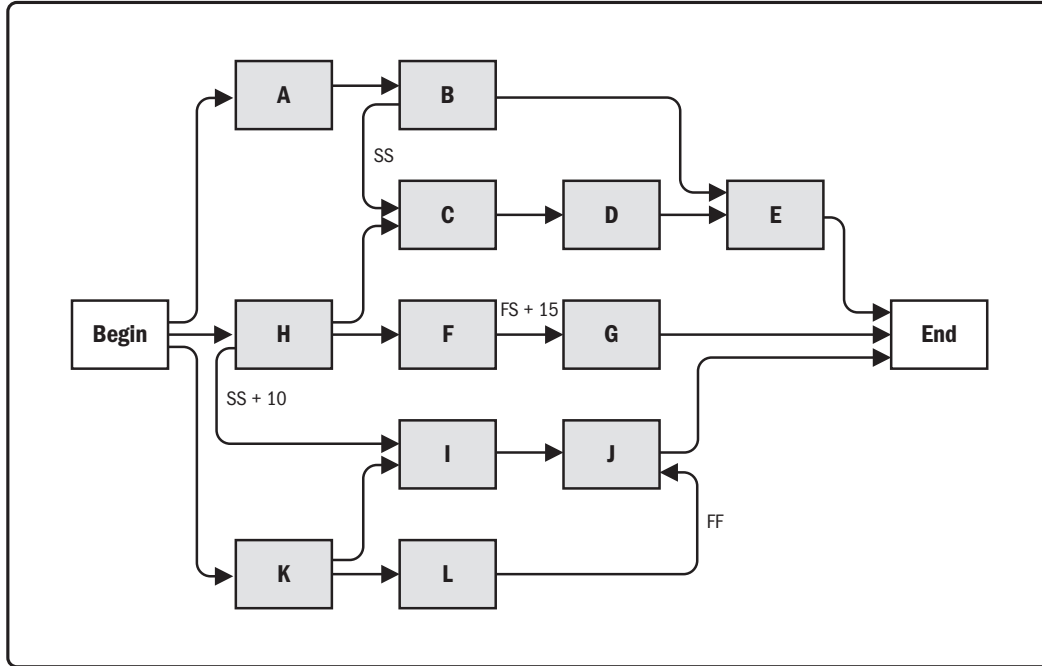

Figure 6-11. Project Schedule Network Diagram

6.3.3.2 Project Documents Updates

Project documents that may be updated include, but are not limited to:

- Activity lists,
- Activity attributes,
- Milestone list, and
- Risk register.

6.4 Estimate Activity Resources

Estimate Activity Resources is the process of estimating the type and quantities of material, human resources, equipment, or supplies required to perform each activity. The key benefit of this process is that it identifies the type, quantity, and characteristics of resources required to complete the activity which allows more accurate cost and duration estimates. The inputs, tools and techniques, and outputs of this process are depicted in Figure 6-12. Figure 6-13 depicts the data flow diagram of the process.

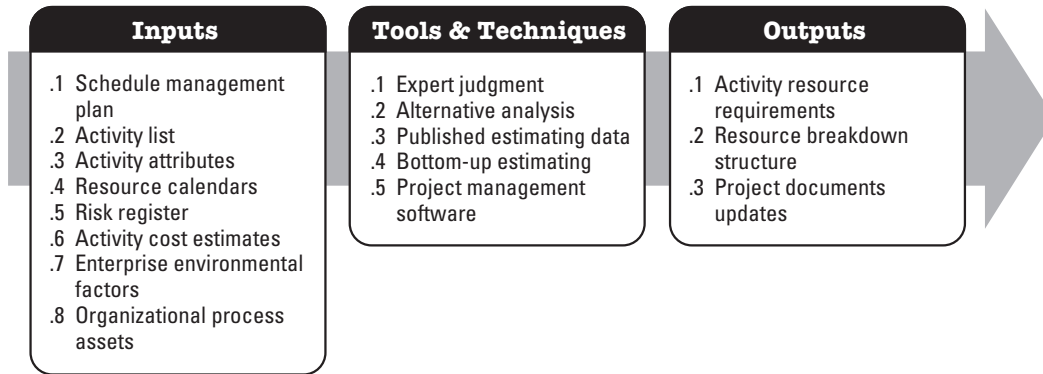

Figure 6-12. Estimate Activity Resources: Inputs, Tools & Techniques, and Outputs

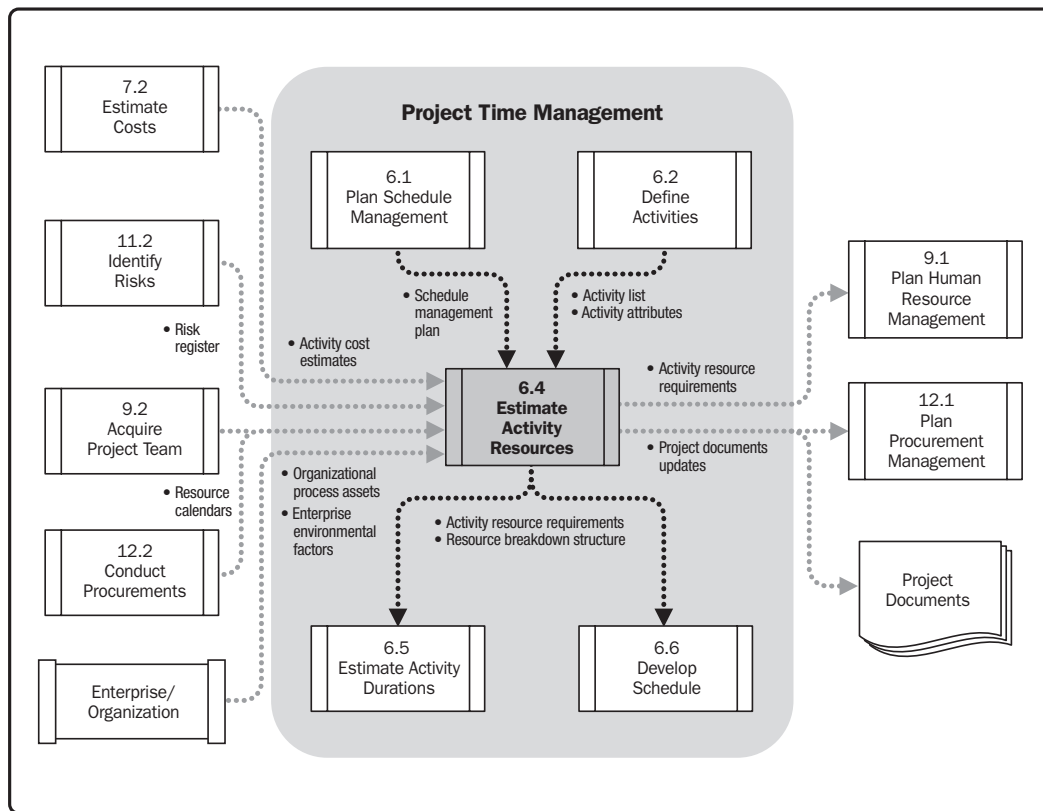

Figure 6-13. Estimate Activity Resources Data Flow Diagram

The Estimate Activity Resources process is closely coordinated with the Estimate Costs process (Section 7.2). For example:

- A construction project team will need to be familiar with local building codes. Such knowledge is often readily available from local sellers. However, if the local labor pool lacks experience with unusual or specialized construction techniques, the additional cost for a consultant may be the most effective way to secure knowledge of the local building codes.
- An automotive design team will need to be familiar with the latest in automated assembly techniques. The requisite knowledge might be obtained by hiring a consultant, by sending a designer to a seminar on robotics, or by including someone from manufacturing as a member of the project team.

6.4.1 Estimate Activity Resources: Inputs

6.4.1.1 Schedule Management Plan

Described in Section 6.1.3.1. The schedule management plan identifies the level of accuracy and the units of measure for the resources to be estimated.

6.4.1.2 Activity List

Described in Section 6.2.3.1. The activity list identifies the activities which will need resources.

6.4.1.3 Activity Attributes

Described in Section 6.2.3.2. The activity attributes provide the primary data input for use in estimating those resources required for each activity in the activity list.

6.4.1.4 Resource Calendars

Described in Sections 9.2.3.2 and 12.2.3.3. A resource calendar is a calendar that identifies the working days and shifts on which each specific resource is available. Information on which resources (such as human resources, equipment, and material) are potentially available during a planned activity period, is used for estimating resource utilization. Resource calendars specify when and how long identified project resources will be available during the project. This information may be at the activity or project level. This knowledge includes consideration of attributes such as resource experience and/or skill level, as well as various geographical locations from which the resources originate and when they may be available.

6.4.1.5 Risk Register

Described in Section 11.2.3.1. Risk events may impact resource selection and availability. Updates to the risk register are included with project documents updates, described in Section 11.5.3.2, from Plan Risk Responses.

6.4.1.6 Activity Cost Estimates

Described in Section 7.2.3.1. The cost of resources may impact resource selection.

6.4.1.7 Enterprise Environmental Factors

Described in Section 2.1.5. The enterprise environmental factors that can influence the Estimate Activity Resources process include, but are not limited to, resource location, availability, and skills.

6.4.1.8 Organizational Process Assets

Described in Section 2.1.4. The organizational process assets that can influence the Estimate Activity Resources process include, but are not limited to:

- Policies and procedures regarding staffing,
- Policies and procedures relating to rental and purchase of supplies and equipment, and
- Historical information regarding types of resources used for similar work on previous projects.

6.4.2 Estimate Activity Resources: Tools and Techniques

6.4.2.1 Expert Judgment

Expert judgment is often required to assess the resource-related inputs to this process. Any group or person with specialized knowledge in resource planning and estimating can provide such expertise.

6.4.2.2 Alternative Analysis

Many schedule activities have alternative methods of accomplishment. They include using various levels of resource capability or skills, different size or type of machines, different tools (hand versus automated), and make-or-buy decisions regarding the resource (Section 12.1.3.5).

6.4.2.3 Published Estimating Data

Several organizations routinely publish updated production rates and unit costs of resources for an extensive array of labor trades, material, and equipment for different countries and geographical locations within countries.

6.4.2.4 Bottom-Up Estimating

Bottom-up estimating is a method of estimating project duration or cost by aggregating the estimates of the lower-level components of the WBS. When an activity cannot be estimated with a reasonable degree of confidence, the work within the activity is decomposed into more detail. The resource needs are estimated. These estimates are then aggregated into a total quantity for each of the activity's resources. Activities may or may not have dependencies between them that can affect the application and use of resources. If there are dependencies, this pattern of resource usage is reflected and documented in the estimated requirements of the activity.

6.4.2.5 Project Management Software

Project management software, such as a scheduling software tool, has the capability to help plan, organize, and manage resource pools and develop resource estimates. Depending on the sophistication of the software, resource breakdown structures, resource availability, resource rates, and various resource calendars can be defined to assist in optimizing resource utilization.

6.4.3 Estimate Activity Resources: Outputs

6.4.3.1 Activity Resource Requirements

Activity resource requirements identify the types and quantities of resources required for each activity in a work package. These requirements then can be aggregated to determine the estimated resources for each work package and each work period. The amount of detail and the level of specificity of the resource requirement descriptions can vary by application area. The resource requirements documentation for each activity can include the basis of estimate for each resource, as well as the assumptions that were made in determining which types of resources are applied, their availability, and what quantities are used.

6.4.3.2 Resource Breakdown Structure

The resource breakdown structure is a hierarchical representation of resources by category and type. Examples of resource categories include labor, material, equipment, and supplies. Resource types may include the skill level, grade level, or other information as appropriate to the project. The resource breakdown structure is useful for organizing and reporting project schedule data with resource utilization information.

6.4.3.3 Project Documents Updates

Project documents that may be updated include, but are not limited to:

- Activity list,
- Activity attributes, and
- Resource calendars.

6.5 Estimate Activity Durations

Estimate Activity Durations is the process of estimating the number of work periods needed to complete individual activities with estimated resources. The key benefit of this process is that it provides the amount of time each activity will take to complete, which is a major input into the Develop Schedule process. The inputs, tools and techniques, and outputs of this process are depicted in Figure 6-14. Figure 6-15 depicts the data flow diagram of the process.

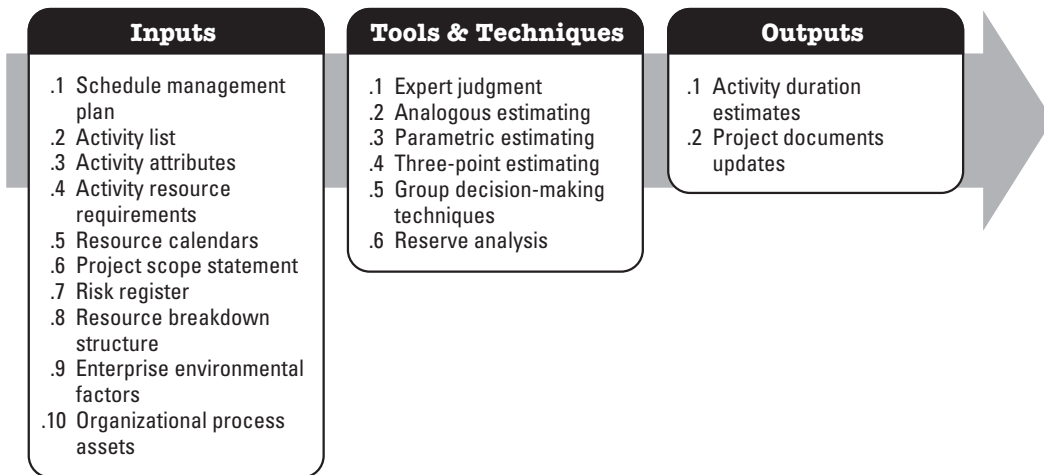

Figure 6-14. Estimate Activity Durations: Inputs, Tools & Techniques, and Outputs

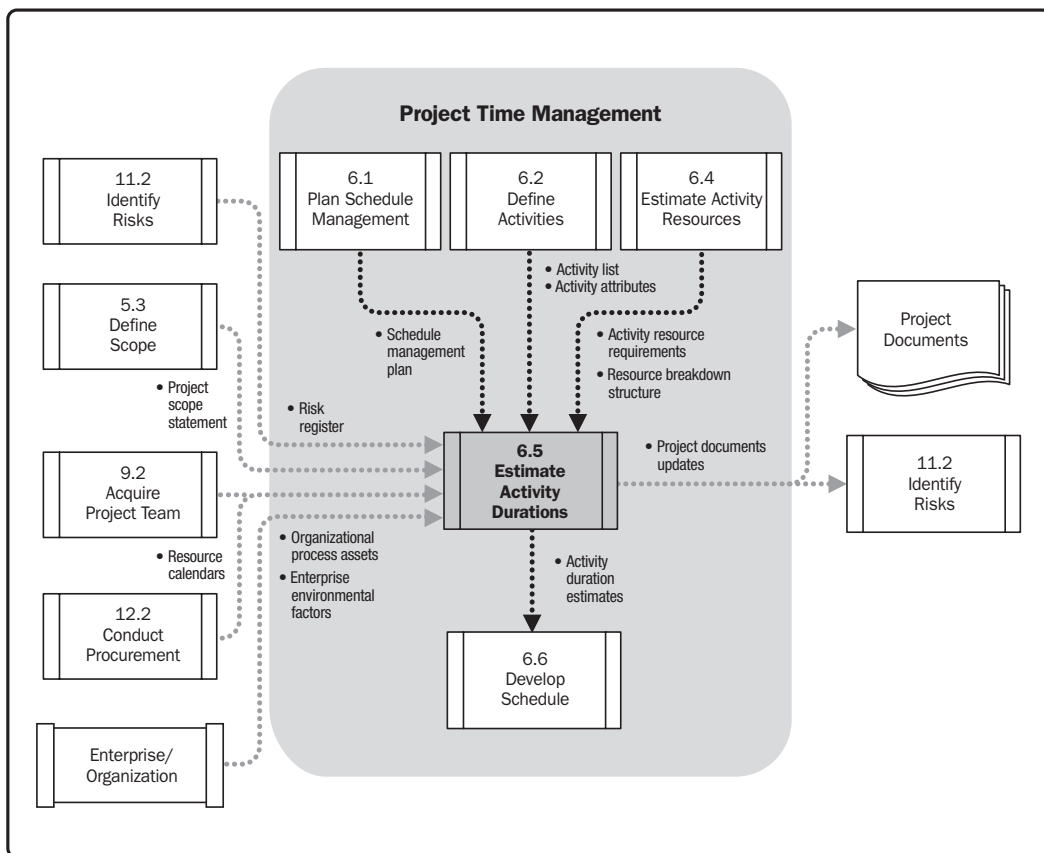

Figure 6-15. Estimate Activity Durations Data Flow Diagram

Estimating activity durations uses information on activity scope of work, required resource types, estimated resource quantities, and resource calendars. The inputs of the estimates of activity duration originate from the person or group on the project team who is most familiar with the nature of the work in the specific activity. The duration estimate is progressively elaborated, and the process considers the quality and availability of the input data. For example, as more detailed and precise data is available about the project engineering and design work, the accuracy of the duration estimates improves. Thus, the duration estimate can be assumed to be progressively more accurate and of better quality.

The Estimate Activity Durations process requires an estimation of the amount of work effort required to complete the activity and the amount of available resources estimated to complete the activity. These estimates are used to approximate the number of work periods (activity duration) needed to complete the activity using the appropriate project and resource calendars. All data and assumptions that support duration estimating are documented for each estimate of activity duration.

6.5.1 Estimate Activity Durations: Inputs

6.5.1.1 Schedule Management Plan

Described in Section 6.1.3.1. The schedule management plan defines the method used and the level of accuracy along with other criteria required to estimate activity durations including the project update cycle.

6.5.1.2 Activity List

Described in Section 6.2.3.1. The activity list identifies the activities that will need duration estimates.

6.5.1.3 Activity Attributes

Described in Section 6.2.3.2. The activity attributes provide the primary data input for use in estimating durations required for each activity in the activity list.

6.5.1.4 Activity Resource Requirements

Described in Section 6.4.3.1. The estimated activity resource requirements will have an effect on the duration of the activity, since the level to which the resources assigned to the activity meet the requirements will significantly influence the duration of most activities. For example, if additional or lower-skilled resources are assigned to an activity, there may be reduced efficiency or productivity due to increased communication, training, and coordination needs leading to a longer duration estimate.

6.5.1.5 Resource Calendars

Described in Section 6.4.1.4. The resource calendars influence the duration of schedule activities due to the availability of specific resources, type of resources, and resources with specific attributes. For example, when staff members are assigned to an activity on a full-time basis, in general, a skilled staff member can be expected to complete a given activity in less time than a relatively less-skilled staff member.

6.5.1.6 Project Scope Statement

Described in Section 5.3.3.1. The assumptions and constraints from the project scope statement are considered when estimating the activity durations. Examples of assumptions include, but are not limited to:

- Existing conditions,
- Availability of information, and
- Length of the reporting periods.

Examples of constraints include, but are not limited to:

- Available skilled resources, and
- Contract terms and requirements.

6.5.1.7 Risk Register

Described in Section 11.2.3.1. The risk register provides the list of risks, along with the results of risk analysis and risk response planning. Updates to the risk register are included with project document updates described in Section 11.5.3.2.

6.5.1.8 Resource Breakdown Structure

Described in Section 6.4.3.2. The resource breakdown structure provides a hierarchical structure of the identified resources by resource category and resource type.

6.5.1.9 Enterprise Environmental Factors

Described in Section 2.1.5. The enterprise environmental factors that can influence the Estimate Activity Durations process include, but are not limited to:

- Duration estimating databases and other reference data,
- Productivity metrics,
- Published commercial information, and
- Location of team members.

6.5.1.10 Organizational Process Assets

Described in Section 2.1.4. The organizational process assets that can influence the Estimate Activity Durations process include, but are not limited to:

- Historical duration information,
- Project calendars,
- Scheduling methodology, and
- Lessons learned.

6.5.2 Estimate Activity Durations: Tools and Techniques

6.5.2.1 Expert Judgment

Expert judgment, guided by historical information, can provide duration estimate information or recommended maximum activity durations from prior similar projects. Expert judgment can also be used to determine whether to combine methods of estimating and how to reconcile differences between them.

6.5.2.2 Analogous Estimating

Analogous estimating is a technique for estimating the duration or cost of an activity or a project using historical data from a similar activity or project. Analogous estimating uses parameters from a previous, similar project, such as duration, budget, size, weight, and complexity, as the basis for estimating the same parameter or measure for a future project. When estimating durations, this technique relies on the actual duration of previous, similar projects as the basis for estimating the duration of the current project. It is a gross value estimating approach, sometimes adjusted for known differences in project complexity. Analogous duration estimating is frequently used to estimate project duration when there is a limited amount of detailed information about the project.

Analogous estimating is generally less costly and less time consuming than other techniques, but it is also less accurate. Analogous duration estimates can be applied to a total project or to segments of a project and may be used in conjunction with other estimating methods. Analogous estimating is most reliable when the previous activities are similar in fact and not just in appearance, and the project team members preparing the estimates have the needed expertise.

6.5.2.3 Parametric Estimating

Parametric estimating is an estimating technique in which an algorithm is used to calculate cost or duration based on historical data and project parameters. Parametric estimating uses a statistical relationship between historical data and other variables (e.g., square footage in construction) to calculate an estimate for activity parameters, such as cost, budget, and duration.

Activity durations can be quantitatively determined by multiplying the quantity of work to be performed by labor hours per unit of work. For example, activity duration on a design project is estimated by the number of drawings multiplied by the number of labor hours per drawing, or on a cable installation, the meters of cable multiplied by the number of labor hours per meter. For example, if the assigned resource is capable of installing 25 meters of cable per hour, the duration required to install 1,000 meters is 40 hours. (1,000 meters divided by 25 meters per hour).

This technique can produce higher levels of accuracy depending upon the sophistication and underlying data built into the model. Parametric time estimates can be applied to a total project or to segments of a project, in conjunction with other estimating methods.

6.5.2.4 Three-Point Estimating

The accuracy of single-point activity duration estimates may be improved by considering estimation uncertainty and risk. This concept originated with the program evaluation and review technique (PERT). PERT uses three estimates to define an approximate range for an activity's duration:

- **Most likely** (tM). This estimate is based on the duration of the activity, given the resources likely to be assigned, their productivity, realistic expectations of availability for the activity, dependencies on other participants, and interruptions.
- **Optimistic** (tO). The activity duration based on analysis of the best-case scenario for the activity.
- **Pessimistic** (tP). The activity duration based on analysis of the worst-case scenario for the activity.

Depending on the assumed distribution of values within the range of the three estimates the expected duration, tE , can be calculated using a formula. Two commonly used formulas are triangular and beta distributions. The formulas are:

- **Triangular Distribution.** $tE = (tO + tM + tP) / 3$
- **Beta Distribution** (from the traditional PERT technique). $tE = (tO + 4tM + tP) / 6$

Duration estimates based on three points with an assumed distribution provide an expected duration and clarify the range of uncertainty around the expected duration.

6.5.2.5 Group Decision-Making Techniques

Team-based approaches, such as brainstorming, the Delphi or nominal group techniques, are useful for engaging team members to improve estimate accuracy and commitment to the emerging estimates. By involving a structured group of people who are close to the technical execution of work in the estimation process, additional information is gained and more accurate estimates obtained. Additionally, when people are involved in the estimation process, their commitment towards meeting the resulting estimates increases.

6.5.2.6 Reserve Analysis

Duration estimates may include contingency reserves, sometimes referred to as time reserves or buffers, into the project schedule to account for schedule uncertainty. Contingency reserves are the estimated duration within the schedule baseline, which is allocated for identified risks that are accepted and for which contingent or mitigation responses are developed. Contingency reserves are associated with the “known-unknowns,” which may be estimated to account for this unknown amount of rework. The contingency reserve may be a percentage of the estimated activity duration, a fixed number of work periods, or may be developed by using quantitative analysis methods such as Monte Carlo simulation (Section 11.4.2.2). Contingency reserves may be separated from the individual activities and aggregated into buffers as shown in Figure 6-19.

As more precise information about the project becomes available, the contingency reserve may be used, reduced, or eliminated. Contingency should be clearly identified in schedule documentation.

Estimates may also be produced for the amount of management reserve of time for the project. Management reserves are a specified amount of the project duration withheld for management control purposes and are reserved for unforeseen work that is within scope of the project. Management reserves are intended to address the “unknown-unknowns” that can affect a project. Management reserve is not included in the schedule baseline, but it is part of the overall project duration requirements. Depending on contract terms, use of management reserves may require a change to the schedule baseline.

6.5.3 Estimate Activity Durations: Outputs

6.5.3.1 Activity Duration Estimates

Activity duration estimates are quantitative assessments of the likely number of time periods that are required to complete an activity. Duration estimates do not include any lags as described in Section 6.3.2.3. Activity duration estimates may include some indication of the range of possible results. For example:

- 2 weeks \pm 2 days, which indicates that the activity will take at least eight days and not more than twelve (assuming a five-day workweek); and
- 15 % probability of exceeding three weeks, which indicates a high probability—85 %—that the activity will take three weeks or less.

6.5.3.2 Project Documents Updates

Project documents that may be updated include, but are not limited to:

- Activity attributes; and
- Assumptions made in developing the activity duration estimate, such as skill levels and availability, as well as a basis of estimates for durations.

6.6 Develop Schedule

Develop Schedule is the process of analyzing activity sequences, durations, resource requirements, and schedule constraints to create the project schedule model. The key benefit of this process is that by entering schedule activities, durations, resources, resource availabilities, and logical relationships into the scheduling tool, it generates a schedule model with planned dates for completing project activities. The inputs, tools and techniques, and outputs of this process are depicted in Figure 6-16. Figure 6-17 depicts the data flow diagram of the process.

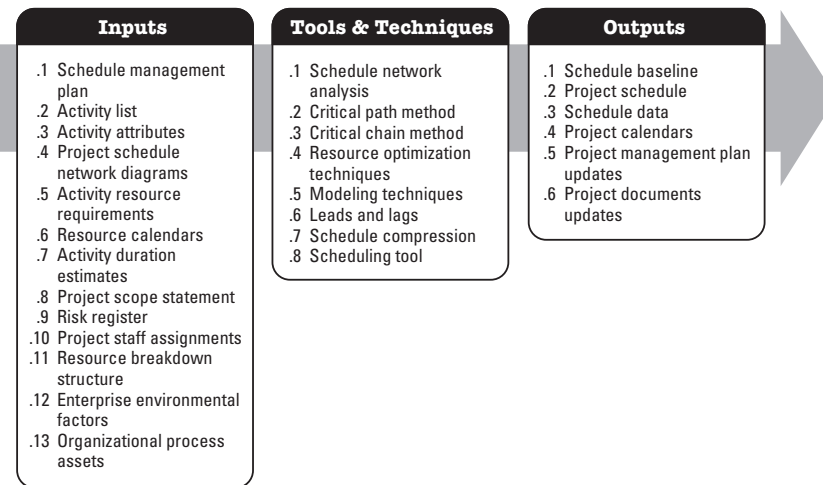

Figure 6-16 Develop Schedule: Inputs, Tools & Techniques, and Outputs

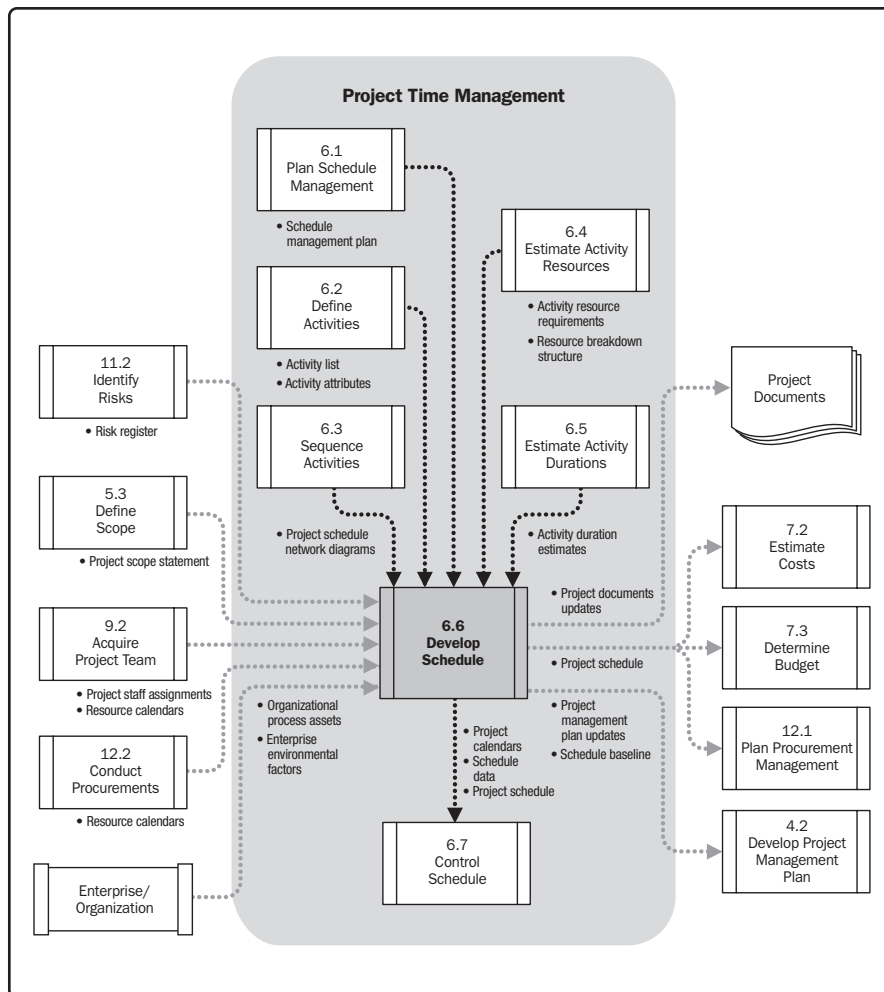

Figure 6-17. Develop Schedule Data Flow Diagram

Developing an acceptable project schedule is often an iterative process. The schedule model is used to determine the planned start and finish dates for project activities and milestones based on the accuracy of the inputs. Schedule development can require the review and revision of duration estimates and resource estimates to create the project schedule model to establish an approved project schedule that can serve as a baseline to track progress. Once the activity start and finish dates have been determined, it is common to have project staff assigned to the activities review their assigned activities and confirm that the start and finish dates present no conflict with resource calendars or assigned activities in other projects or tasks and thus are still valid. As work progresses, revising and maintaining the project schedule model to sustain a realistic schedule continues throughout the duration of the project, as described in Section 6.7.

For more specific information regarding scheduling, refer to the *Practice Standard for Scheduling*.

6.6.1 Develop Schedule: Inputs

6.6.1.1 Schedule Management Plan

Described in Section 6.1.3.1. The schedule management plan identifies the scheduling method and tool used to create the schedule, and how the schedule is to be calculated.

6.6.1.2 Activity List

Described in Section 6.2.3.1. The activity list identifies the activities that will be included in the schedule model.

6.6.1.3 Activity Attributes

Described in Section 6.2.3.2. The activity attributes provide the details used to build the schedule model.

6.6.1.4 Project Schedule Network Diagrams

Described in Section 6.3.3.1. The project schedule network diagrams contain the logical relationships of predecessors and successors that will be used to calculate the schedule.

6.6.1.5 Activity Resource Requirements

Described in Section 6.4.3.1. The activity resource requirements identify the types and quantities of resources required for each activity used to create the schedule model.

6.6.1.6 Resource Calendars

Described in Sections 9.2.3.2 and 12.2.3.3. The resource calendars contain information on the availability of resources during the project.

6.6.1.7 Activity Duration Estimates

Described in Section 6.5.3.1. The activity duration estimates contain the quantitative assessments of the likely number of work periods that will be required to complete an activity that will be used to calculate the schedule.

6.6.1.8 Project Scope Statement

Described in Section 5.3.3.1. The project scope statement contains assumptions and constraints that can impact the development of the project schedule.

6.6.1.9 Risk Register

Described in Section 11.2.3.1. The risk register provides the details of all identified risks and their characteristics that affect the schedule model.

6.6.1.10 Project Staff Assignments

Described in Section 9.2.3.1. The project staff assignments specify which resources are assigned to each activity.

6.6.1.11 Resource Breakdown Structure

Described in Section 6.4.3.2. The resource breakdown structure provides the details by which resource analysis and organizational reporting can be done.

6.6.1.12 Enterprise Environmental Factors

Described in Section 2.1.5. The enterprise environmental factors include, but are not limited to:

- Standards,
- Communication channels, and
- Scheduling tool to be used in developing the schedule model.

6.6.1.13 Organizational Process Assets

Described in Section 2.1.4. The organizational process assets that can influence the Develop Schedule process include, but are not limited to: scheduling methodology and project calendar(s).

6.6.2 Develop Schedule: Tools and Techniques

6.6.2.1 Schedule Network Analysis

Schedule network analysis is a technique that generates the project schedule model. It employs various analytical techniques, such as critical path method, critical chain method, what-if analysis, and resource optimization techniques to calculate the early and late start and finish dates for the uncompleted portions of project activities. Some network paths may have points of path convergence or path divergence that can be identified and used in schedule compression analysis or other analyses.

6.6.2.2 Critical Path Method

The critical path method, which is a method used to estimate the minimum project duration and determine the amount of scheduling flexibility on the logical network paths within the schedule model. This schedule network analysis technique calculates the early start, early finish, late start, and late finish dates for all activities without regard for any resource limitations by performing a forward and backward pass analysis through the schedule network, as shown in Figure 6-18. In this example the longest path includes activities A, C, and D, and, therefore, the sequence of A-C-D is the critical path. The critical path is the sequence of activities that represents the longest path through a project, which determines the shortest possible project duration. The resulting early and late start and finish dates are not necessarily the project schedule, rather they indicate the time periods within which the activity could be executed, using the parameters entered in the schedule model for activity durations, logical relationships, leads, lags, and other known constraints. The critical path method is used to calculate the amount of scheduling flexibility on the logical network paths within the schedule model.

On any network path, the schedule flexibility is measured by the amount of time that a schedule activity can be delayed or extended from its early start date without delaying the project finish date or violating a schedule constraint, and is termed “total float.” A CPM critical path is normally characterized by zero total float on the critical path. As implemented with PDM sequencing, critical paths may have positive, zero, or negative total float depending on constraints applied. Any activity on the critical path is called a critical path activity. Positive total float is caused when the backward pass is calculated from a schedule constraint that is later than the early finish date that has been calculated during forward pass calculation. Negative total float is caused when a constraint on the late dates is violated by duration and logic. Schedule networks may have multiple near-critical paths. Many software packages allow the user to define the parameters used to determine the critical path(s). Adjustments to activity durations (if more resources or less scope can be arranged), logical relationships (if the relationships were discretionary to begin with), leads and lags, or other schedule constraints may be necessary to produce network paths with a zero or positive total float. Once the total float for a network path has been calculated, then the free float—the amount of time that a schedule activity can be delayed without delaying the early start date of any successor or violating a schedule constraint—can also be determined. For example the free float for Activity B, in Figure 6-18, is 5 days.

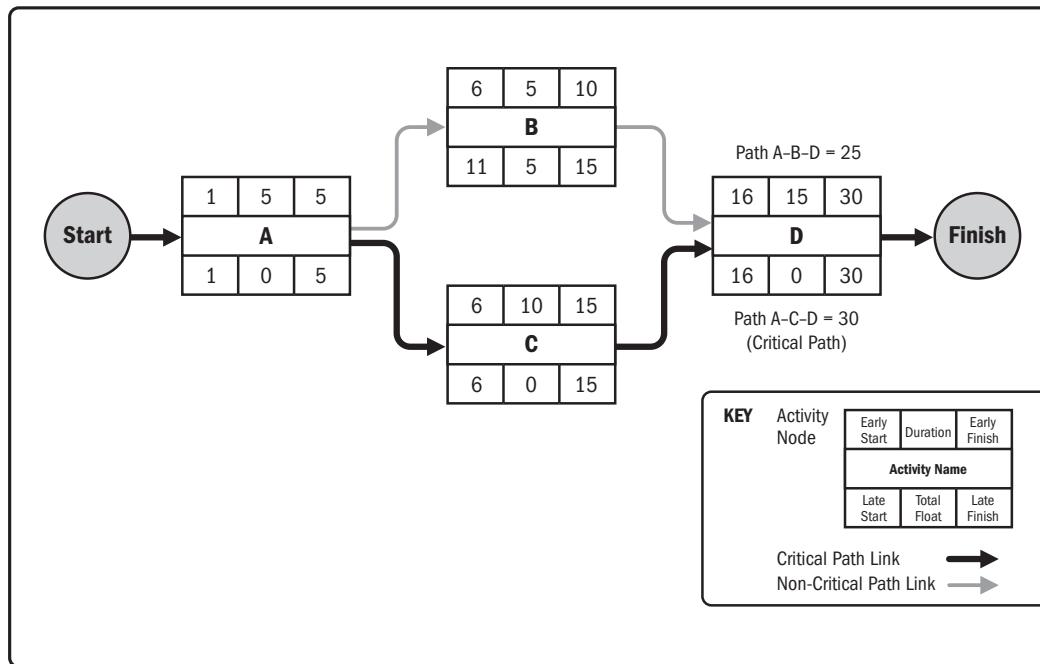

Figure 6-18. Example of Critical Path Method

6.6.2.3 Critical Chain Method

The critical chain method (CCM) is a schedule method that allows the project team to place buffers on any project schedule path to account for limited resources and project uncertainties. It is developed from the critical path method approach and considers the effects of resource allocation, resource optimization, resource leveling, and activity duration uncertainty on the critical path determined using the critical path method. To do so, the critical chain method introduces the concept of buffers and buffer management. The critical chain method uses activities with durations that do not include safety margins, logical relationships, and resource availability with statistically determined buffers composed of the aggregated safety margins of activities at specified points on the project schedule path to account for limited resources and project uncertainties. The resource-constrained critical path is known as the critical chain.

The critical chain method adds duration buffers that are non-work schedule activities to manage uncertainty. One buffer, placed at the end of the critical chain, as shown in Figure 6-19, is known as the project buffer and protects the target finish date from slippage along the critical chain. Additional buffers, known as feeding buffers, are placed at each point where a chain of dependent activities that are not on the critical chain feeds into the critical chain. Feeding buffers thus protect the critical chain from slippage along the feeding chains. The size of each buffer should account for the uncertainty in the duration of the chain of dependent activities leading up to that buffer. Once the buffer schedule activities are determined, the planned activities are scheduled to their latest possible planned start and finish dates. Consequently, instead of managing the total float of network paths, the critical chain method focuses on managing the remaining buffer durations against the remaining durations of chains of activities.

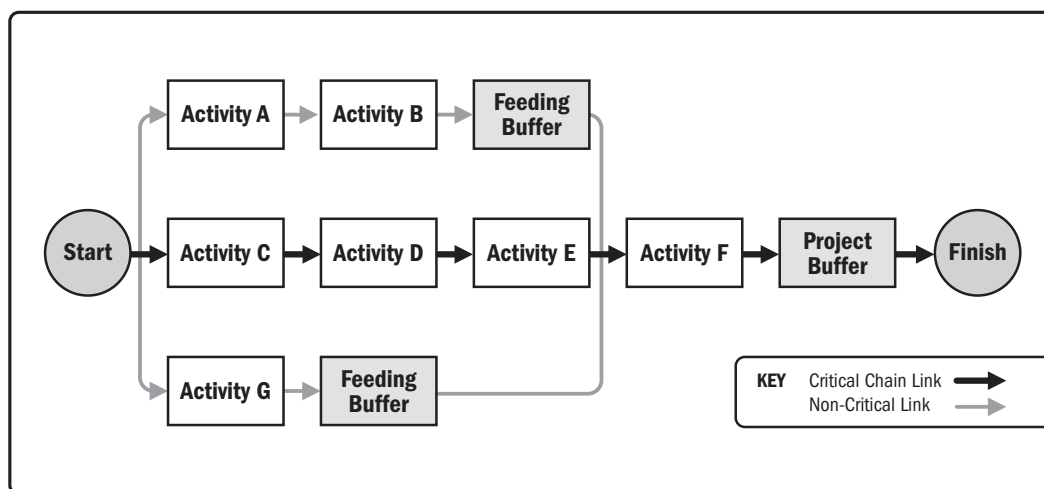

Figure 6-19. Example of Critical Chain Method

6.6.2.4 Resource Optimization Techniques

Examples of resource optimization techniques that can be used to adjust the schedule model due to demand and supply of resources include, but are not limited to:

- Resource leveling.** A technique in which start and finish dates are adjusted based on resource constraints with the goal of balancing demand for resources with the available supply. Resource leveling can be used when shared or critically required resources are only available at certain times, or in limited quantities, or over-allocated, such as when a resource has been assigned to two or more activities during the same time period, as shown in Figure 6-20, or to keep resource usage at a constant level. Resource leveling can often cause the original critical path to change, usually to increase.

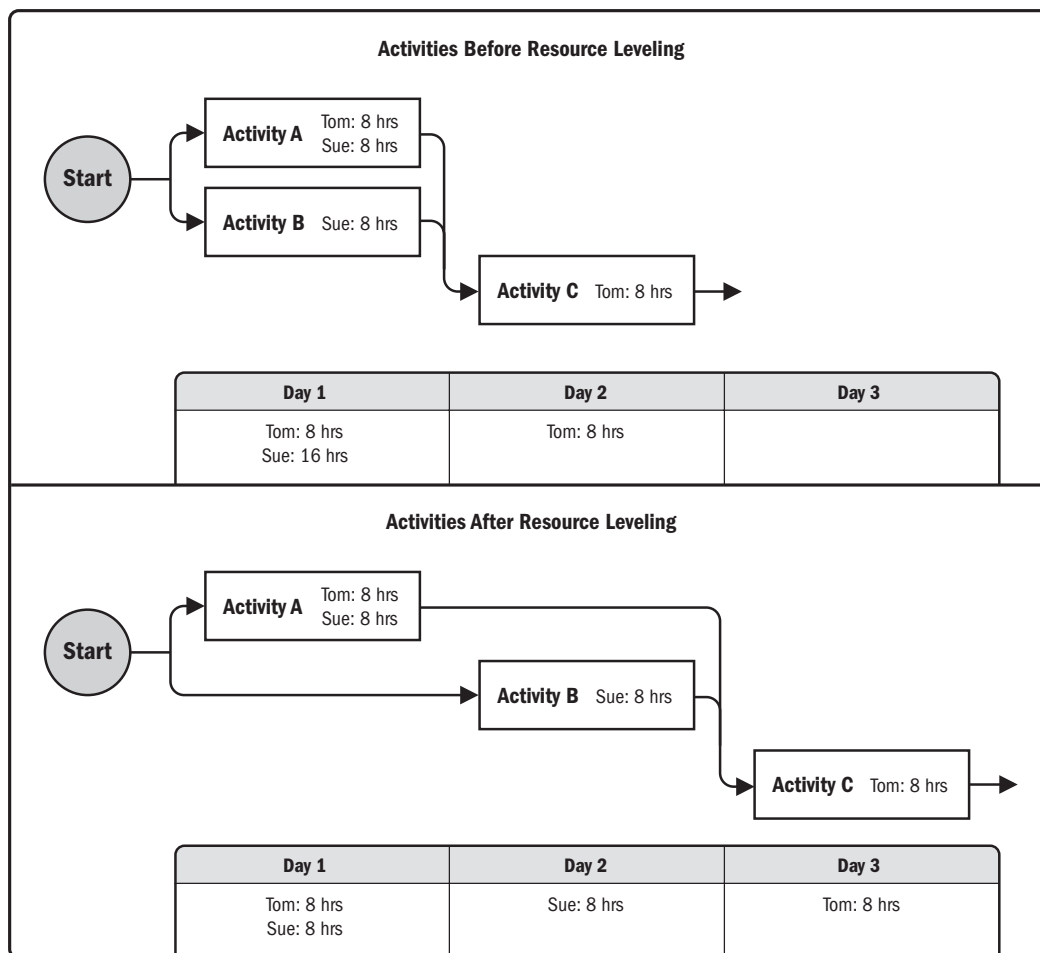

Figure 6-20. Resource Leveling

- **Resource Smoothing.** A technique that adjusts the activities of a schedule model such that the requirements for resources on the project do not exceed certain predefined resource limits. In resource smoothing, as opposed to resource leveling, the project's critical path is not changed and the completion date may not be delayed. In other words, activities may only be delayed within their free and total float. Thus resource smoothing may not be able to optimize all resources.

6.6.2.5 Modeling Techniques

Examples of modeling techniques include, but are not limited to:

- **What-If Scenario Analysis.** What-if scenario analysis is the process of evaluating scenarios in order to predict their effect, positively or negatively, on project objectives. This is an analysis of the question, "What if the situation represented by scenario 'X' happens?" A schedule network analysis is performed using the schedule to compute the different scenarios, such as delaying a major component delivery, extending specific engineering durations, or introducing external factors, such as a strike or a change in the permitting process. The outcome of the what-if scenario analysis can be used to assess the feasibility of the project schedule under adverse conditions, and in preparing contingency and response plans to overcome or mitigate the impact of unexpected situations.
- **Simulation.** Simulation involves calculating multiple project durations with different sets of activity assumptions, usually using probability distributions constructed from the three-point estimates (described in Section 6.5.2.4) to account for uncertainty. The most common simulation technique is Monte Carlo analysis (Section 11.4.2.2), in which a distribution of possible activity durations is defined for each activity and used to calculate a distribution of possible outcomes for the total project.

6.6.2.6 Leads and Lags

Described in Section 6.3.2.3. Leads and lags are refinements applied during network analysis to develop a viable schedule by adjusting the start time of the successor activities. Leads are used in limited circumstances to advance a successor activity with respect to the predecessor activity, and lags are used in limited circumstances where processes require a set period of time to elapse between the predecessors and successors without work or resource impact.

6.6.2.7 Schedule Compression

Schedule compression techniques are used to shorten the schedule duration without reducing the project scope, in order to meet schedule constraints, imposed dates, or other schedule objectives. Schedule compression techniques include, but are not limited to:

- **Crashing.** A technique used to shorten the schedule duration for the least incremental cost by adding resources. Examples of crashing include approving overtime, bringing in additional resources, or paying to expedite delivery to activities on the critical path. Crashing works only for activities on the critical path where additional resources will shorten the activity's duration. Crashing does not always produce a viable alternative and may result in increased risk and/or cost.
- **Fast tracking.** A schedule compression technique in which activities or phases normally done in sequence are performed in parallel for at least a portion of their duration. An example is constructing the foundation for a building before completing all of the architectural drawings. Fast tracking may result in rework and increased risk. Fast tracking only works if activities can be overlapped to shorten the project duration.

6.6.2.8 Scheduling Tool

Automated scheduling tools contain the schedule model and expedite the scheduling process by generating start and finish dates based on the inputs of activities, network diagrams, resources and activity durations using schedule network analysis. A scheduling tool can be used in conjunction with other project management software applications as well as manual methods.

6.6.3 Develop Schedule: Outputs

6.6.3.1 Schedule Baseline

A schedule baseline is the approved version of a schedule model that can be changed only through formal change control procedures and is used as a basis for comparison to actual results. It is accepted and approved by the appropriate stakeholders as the schedule baseline with baseline start dates and baseline finish dates. During monitoring and controlling, the approved baseline dates are compared to the actual start and finish dates to determine whether variances have occurred. The schedule baseline is a component of the project management plan.

6.6.3.2 Project Schedule

The outputs from a schedule model are schedule presentations. The project schedule is an output of a schedule model that presents linked activities with planned dates, durations, milestones, and resources. At a minimum, the project schedule includes a planned start date and planned finish date for each activity. If resource planning is done at an early stage, then the project schedule remains preliminary until resource assignments have been confirmed and scheduled start and finish dates are established. This process usually occurs no later than the completion of the project management plan (Section 4.2.3.1). A target project schedule model may also be developed with a defined target start and target finish for each activity. The project schedule presentation may be presented in summary form, sometimes referred to as the master schedule or milestone schedule, or presented in detail. Although a project schedule model can be presented in tabular form, it is more often presented graphically, using one or more of the following formats, which are classified as presentations:

- **Bar charts.** These charts, also known as Gantt charts, represent schedule information where activities are listed on the vertical axis, dates are shown on the horizontal axis, and activity durations are shown as horizontal bars placed according to start and finish dates. Bar charts are relatively easy to read, and are frequently used in management presentations. For control and management communications, the broader, more comprehensive summary activity, sometimes referred to as a hammock activity, is used between milestones or across multiple interdependent work packages, and is displayed in bar chart reports. An example is the summary schedule portion of Figure 6-21 that is presented in a WBS-structured format.
- **Milestone charts.** These charts are similar to bar charts, but only identify the scheduled start or completion of major deliverables and key external interfaces. An example is the milestone schedule portion of Figure 6-21.
- **Project schedule network diagrams.** These diagrams are commonly presented in the activity-on-node diagram format showing activities and relationships without a time scale, sometimes referred to as a pure logic diagram, as shown in Figure 6-11, or presented in a time-scaled schedule network diagram format that is sometimes called a logic bar chart, as shown for the detailed schedule in Figure 6-21. These diagrams, with activity date information, usually show both the project network logic and the project's critical path schedule activities. This example also shows how each work package is planned as a series of related activities. Another presentation of the project schedule network diagram is a time-scaled logic diagram. These diagrams include a time scale and bars that represent the duration of activities with the logical relationships. It is optimized to show the relationships between activities where any number of activities may appear on the same line of the diagram in sequence.

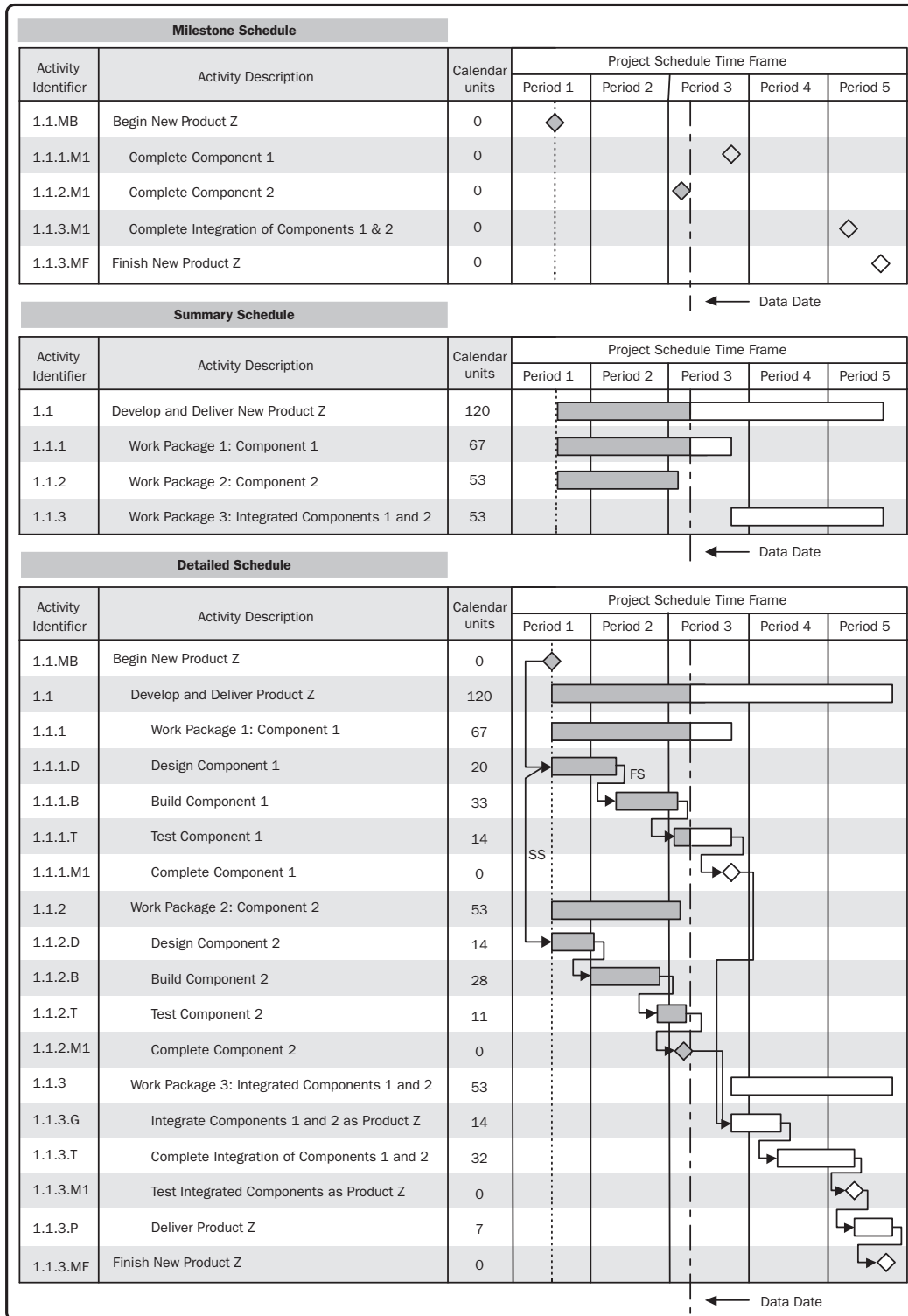

Figure 6-21. Project Schedule Presentations —Examples

Figure 6-21 shows schedule presentations for a sample project being executed, with the work in progress reported through the data date, a point in time when the status of the project is recorded, which is sometimes also called the as-of date or status date. For a simple project schedule model, Figure 6-21 reflects schedule presentations in the forms of (1) a milestone schedule as a milestone chart, (2) a summary schedule as a bar chart, and (3) a detailed schedule as a project schedule network diagram. Figure 6-21 also visually shows the relationships among the three different levels of schedule presentation.

6.6.3.3 Schedule Data

The schedule data for the project schedule model is the collection of information for describing and controlling the schedule. The schedule data includes at least the schedule milestones, schedule activities, activity attributes, and documentation of all identified assumptions and constraints. The amount of additional data varies by application area. Information frequently supplied as supporting detail includes, but is not limited to:

- Resource requirements by time period, often in the form of a resource histogram;
- Alternative schedules, such as best-case or worst-case, not resource-leveled, or resource-leveled, with or without imposed dates; and
- Scheduling of contingency reserves.

Schedule data could also include such items as resource histograms, cash-flow projections, and order and delivery schedules.

6.6.3.4 Project Calendars

A project calendar identifies working days and shifts that are available for scheduled activities. It distinguishes time periods in days or parts of days that are available to complete scheduled activities from time periods that are not available. A schedule model may require more than one project calendar to allow for different work periods for some activities to calculate the project schedule. The project calendars may be updated.

6.6.3.5 Project Management Plan Updates

Elements of the project management plan that may be updated include, but are not limited to:

- Schedule baseline (Section 6.6.3.1),
- Schedule management plan (Section 6.1.3.1).

6.6.3.6 Project Documents Updates

Project documents that may be updated include, but are not limited to:

- **Activity resource requirements.** Resource leveling can have a significant effect on preliminary estimates for the types and quantities of resources required. If the resource-leveling analysis changes the project resource requirements, then the project resource requirements are updated.
- **Activity attributes.** Activity attributes (Section 6.2.3.2) are updated to include any revised resource requirements and any other revisions generated by the Develop Schedule process.
- **Calendars.** The calendar for each project may consist of multiple calendars, project calendars, individual resource calendars etc., as the basis for scheduling the project.
- **Risk register.** The risk register may need to be updated to reflect opportunities or threats perceived through scheduling assumptions.

6.7 Control Schedule

Control Schedule is the process of monitoring the status of project activities to update project progress and manage changes to the schedule baseline to achieve the plan. The key benefit of this process is that it provides the means to recognize deviation from the plan and take corrective and preventive actions and thus minimize risk. The inputs, tools and techniques, and outputs of this process are depicted in Figure 6-22. Figure 6-23 depicts the data flow diagram of the process.

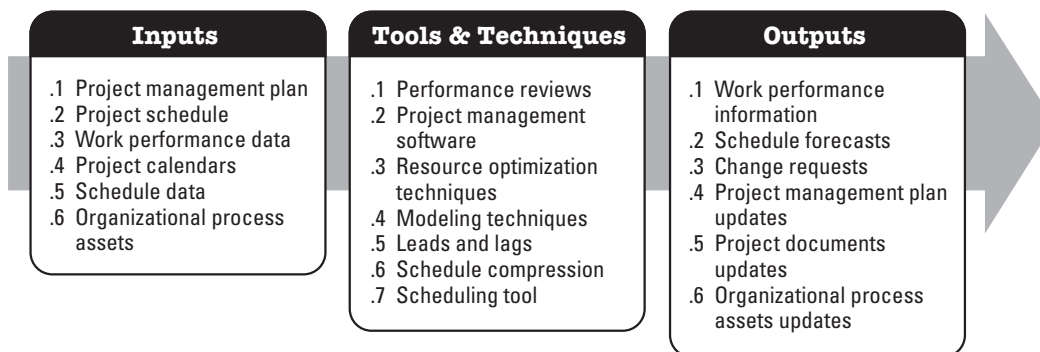

Figure 6-22. Control Schedule: Inputs, Tools & Techniques, and Outputs

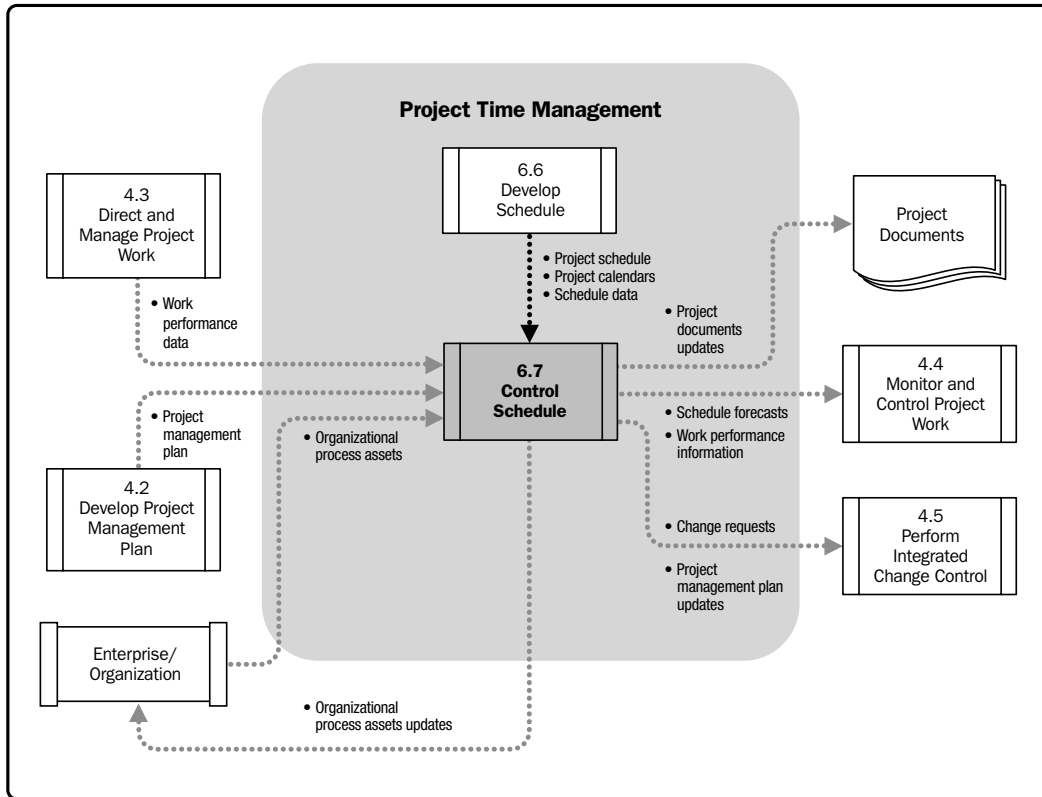

Figure 6-23. Control Schedule Data Flow Diagram

Updating the schedule model requires knowing the actual performance to date. Any change to the schedule baseline can only be approved through the Perform Integrated Change Control process (Section 4.5). Control Schedule, as a component of the Perform Integrated Change Control process, is concerned with:

- Determining the current status of the project schedule,
- Influencing the factors that create schedule changes,
- Determining if the project schedule has changed, and
- Managing the actual changes as they occur.

If any agile approach is utilized, control schedule is concerned with:

- Determining the current status of the project schedule by comparing the total amount of work delivered and accepted against the estimates of work completed for the elapsed time cycle,
- Conducting retrospective reviews (scheduled reviews to record lessons learned) for correcting processes and improving, if required,
- Reprioritizing the remaining work plan (backlog),
- Determining the rate at which the deliverables are produced, validated, and accepted (velocity) in given time per iteration (agreed work cycle duration, typically two weeks or one month),
- Determining that the project schedule has changed, and
- Managing the actual changes as they occur.

6.7.1 Control Schedule: Inputs

6.7.1.1 Project Management Plan

Described in Section 4.2.3.1. The project management plan contains the schedule management plan and the schedule baseline. The schedule management plan describes how the schedule will be managed and controlled. The schedule baseline is used as a reference to compare with actual results to determine if a change, corrective action, or preventive action is necessary.

6.7.1.2 Project Schedule

Described in Section 6.6.3.2. Project schedule refers to the most recent version with notations to indicate updates, completed activities, and started activities as of the indicated data date.

6.7.1.3 Work Performance Data

Described in Section 4.3.3.2. Work performance data refers to information about project progress such as which activities have started, their progress (e.g., actual duration, remaining duration, and physical percent complete), and which activities have finished.

6.7.1.4 Project Calendars

Described in Section 6.6.3.4. A schedule model may require more than one project calendar to allow for different work periods for some activities to calculate the schedule forecasts.

6.7.1.5 Schedule Data

Described in Section 6.6.3.3. Schedule data will be reviewed and updated in the Control Schedule process.

6.7.1.6 Organizational Process Assets

Described in Section 2.1.4. The organizational process assets that influence the Control Schedule process include, but are not limited to:

- Existing formal and informal schedule control-related policies, procedures, and guidelines;
- Schedule control tools; and
- Monitoring and reporting methods to be used.

6.7.2 Control Schedule: Tools and Techniques

6.7.2.1 Performance Reviews

Performance reviews measure, compare, and analyze schedule performance such as actual start and finish dates, percent complete, and remaining duration for work in progress. Various techniques may be used, among them:

- **Trend analysis.** Trend analysis examines project performance over time to determine whether performance is improving or deteriorating. Graphical analysis techniques are valuable for understanding performance to date and for comparison to future performance goals in the form of completion dates.
- **Critical path method (Section 6.6.2.2).** Comparing the progress along the critical path can help determine schedule status. The variance on the critical path will have a direct impact on the project end date. Evaluating the progress of activities on near critical paths can identify schedule risk.

- **Critical chain method (Section 6.6.2.3).** Comparing the amount of buffer remaining to the amount of buffer needed to protect the delivery date can help determine schedule status. The difference between the buffer needed and the buffer remaining can determine whether corrective action is appropriate.
- **Earned value management (Section 7.4.2.1).** Schedule performance measurements such as schedule variance (SV) and schedule performance index (SPI), are used to assess the magnitude of variation to the original schedule baseline. The total float and early finish variances are also essential planning components to evaluate project time performance. Important aspects of schedule control include determining the cause and degree of variance relative to the schedule baseline (Section 6.6.3.1), estimating the implications of those variances for future work to completion, and deciding whether corrective or preventive action is required. For example, a major delay on any activity not on the critical path may have little effect on the overall project schedule, while a much shorter delay on a critical or near-critical activity may require immediate action. For projects not using earned value management, similar variance analysis can be performed by comparing planned activity start or finish dates against actual start or finish dates to identify variances between the schedule baseline and actual project performance. Further analysis can be performed to determine the cause and degree of variance relative to the schedule baseline and any corrective or preventative actions needed.

6.7.2.2 Project Management Software

Project management software for scheduling provides the ability to track planned dates versus actual dates, to report variances to and progress made against the schedule baseline, and to forecast the effects of changes to the project schedule model.

6.7.2.3 Resource Optimization Techniques

Described in Section 6.6.2.4. Resource optimization techniques involve the scheduling of activities and the resources required by those activities while taking into consideration both the resource availability and the project time.

6.7.2.4 Modeling Techniques

Described in Section 6.6.2.5. Modeling techniques are used to review various scenarios guided by risk monitoring to bring the schedule model into alignment with the project management plan and approved baseline.

6.7.2.5 Leads and Lags

Adjusting leads and lags is applied during network analysis to find ways to bring project activities that are behind into alignment with the plan. For example, on a project to construct a new office building, the landscaping can be adjusted to start before the exterior work of the building is complete by increasing the lead time in the relationship. Or, a technical writing team can adjust the start of editing the draft of a large document immediately after the document is completed by eliminating or decreasing lag time.

6.7.2.6 Schedule Compression

Described in Section 6.6.2.7. Schedule compression techniques are used to find ways to bring project activities that are behind into alignment with the plan by fast tracking or crashing schedule for the remaining work.

6.7.2.7 Scheduling Tool

Schedule data is updated and compiled into the schedule model to reflect actual progress of the project and remaining work to be completed. The scheduling tool (Section 6.6.2.8) and the supporting schedule data are used in conjunction with manual methods or other project management software to perform schedule network analysis to generate an updated project schedule.

6.7.3 Control Schedule: Outputs

6.7.3.1 Work Performance Information

The calculated SV and SPI time performance indicators for WBS components, in particular the work packages and control accounts, are documented and communicated to stakeholders.

6.7.3.2 Schedule Forecasts

Schedule forecasts are estimates or predictions of conditions and events in the project's future based on information and knowledge available at the time of the forecast. Forecasts are updated and reissued based on work performance information provided as the project is executed. The information is based on the project's past performance and expected future performance, and includes earned value performance indicators that could impact the project in the future.

6.7.3.3 Change Requests

Schedule variance analysis, along with review of progress reports, results of performance measures, and modifications to the project scope or project schedule may result in change requests to the schedule baseline, scope baseline, and/or other components of the project management plan. Change requests are processed for review and disposition through the Perform Integrated Change Control process (Section 4.5). Preventive actions may include recommended changes to eliminate or reduce the probability of negative schedule variances.

6.7.3.4 Project Management Plan Updates

Elements of the project management plan that may be updated include, but are not limited to:

- **Schedule baseline.** Changes to the schedule baseline are incorporated in response to approved change requests (Section 4.4.3.1) related to project scope changes, activity resources, or activity duration estimates. The schedule baseline may be updated to reflect changes caused by schedule compression techniques.
- **Schedule management plan.** The schedule management plan may be updated to reflect a change in the way the schedule is managed.
- **Cost baseline.** The cost baseline may be updated to reflect approved change requests or changes caused by compression techniques.

6.7.3.5 Project Documents Updates

Project documents that may be updated include, but are not limited to:

- **Schedule Data.** New project schedule network diagrams may be developed to display approved remaining durations and approved modifications to the schedule. In some cases, project schedule delays can be so severe that development of a new target schedule with forecasted start and finish dates is needed to provide realistic data for directing the work, measuring performance, and measuring progress.
- **Project Schedule.** An updated project schedule will be generated from the schedule model populated with updated schedule data to reflect the schedule changes and manage the project.
- **Risk Register.** The risk register, and risk response plans within it, may also be updated based on the risks that may arise due to schedule compression techniques.

6.7.3.6 Organizational Process Assets Updates

Organizational process assets that may be updated include, but are not limited to:

- Causes of variances,
- Corrective action chosen and the reasons, and
- Other types of lessons learned from project schedule control.

7

PROJECT COST MANAGEMENT

Project Cost Management includes the processes involved in planning, estimating, budgeting, financing, funding, managing, and controlling costs so that the project can be completed within the approved budget.

Figure 7-1 provides an overview of the following Project Cost Management processes:

7.1 Plan Cost Management—The process that establishes the policies, procedures, and documentation for planning, managing, expending, and controlling project costs.

7.2 Estimate Costs—The process of developing an approximation of the monetary resources needed to complete project activities.

7.3 Determine Budget—The process of aggregating the estimated costs of individual activities or work packages to establish an authorized cost baseline.

7.4 Control Costs—The process of monitoring the status of the project to update the project costs and managing changes to the cost baseline.

These processes interact with each other and with processes in other Knowledge Areas as described in detail in Section 3 and Annex A1.

On some projects, especially those of smaller scope, cost estimating and cost budgeting are tightly linked and can be viewed as a single process that can be performed by a single person over a relatively short period of time. These are presented here as distinct processes because the tools and techniques for each are different. The ability to influence cost is greatest at the early stages of the project, making early scope definition critical (Section 5.3).

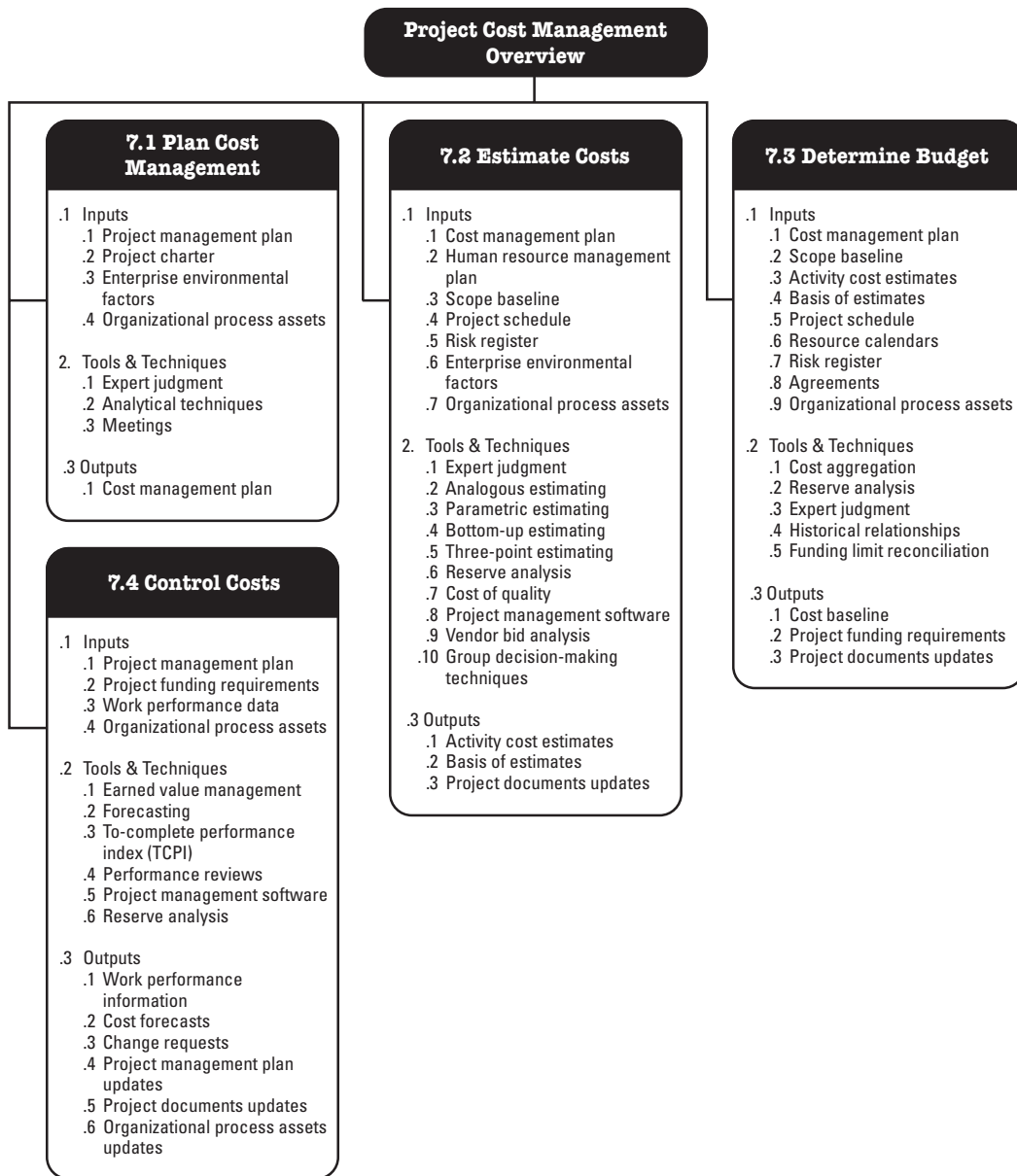

Figure 7-1. Project Cost Management Overview

Project Cost Management should consider the stakeholder requirements for managing costs. Different stakeholders will measure project costs in different ways and at different times. For example, the cost of an acquired item may be measured when the acquisition decision is made or committed, the order is placed, the item is delivered, or the actual cost is incurred or recorded for project accounting purposes.

Project Cost Management is primarily concerned with the cost of the resources needed to complete project activities. Project Cost Management should also consider the effect of project decisions on the subsequent recurring cost of using, maintaining, and supporting the product, service, or result of the project. For example, limiting the number of design reviews can reduce the cost of the project but could increase the resulting product's operating costs.

In many organizations, predicting and analyzing the prospective financial performance of the project's product is performed outside of the project. In others, such as a capital facilities project, Project Cost Management can include this work. When such predictions and analyses are included, Project Cost Management may address additional processes and numerous general financial management techniques such as return on investment, discounted cash flow, and investment payback analysis.

The cost management planning effort occurs early in project planning and sets the framework for each of the cost management processes so that performance of the processes will be efficient and coordinated.

7.1 Plan Cost Management

Plan Cost Management is the process that establishes the policies, procedures, and documentation for planning, managing, expending, and controlling project costs. The key benefit of this process is that it provides guidance and direction on how the project costs will be managed throughout the project. The inputs, tools and techniques, and outputs of this process are depicted in Figure 7-2. Figure 7-3 depicts the data flow diagram of the process.



Figure 7-2. Plan Cost Management: Inputs, Tools & Techniques, and Outputs

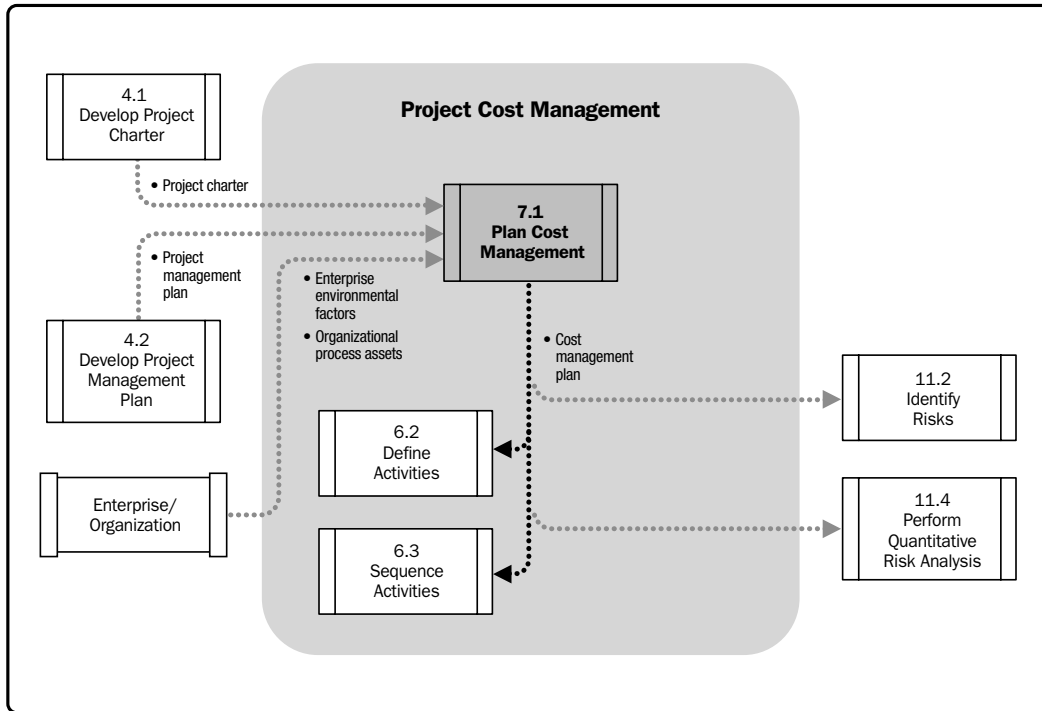

Figure 7-3. Plan Cost Management: Data Flow Diagram

The cost management processes and their associated tools and techniques are documented in the cost management plan. The cost management plan is a component of the project management plan.

7.1.1 Plan Cost Management: Inputs

7.1.1.1 Project Management Plan

Described in Section 4.2.3.1. The project management plan contains information used to develop the cost management plan, which contains, but is not limited to:

- **Scope baseline.** The scope baseline includes the project scope statement and WBS detail for cost estimation and management.
- **Schedule baseline.** The schedule baseline defines when the project costs will be incurred.
- **Other information.** Other cost-related scheduling, risk, and communications decisions from the project management plan.

7.1.1.2 Project Charter

Described in Section 4.1.3.1. The project charter provides the summary budget from which the detailed project costs are developed. The project charter also defines the project approval requirements that will influence the management of the project costs.

7.1.1.3 Enterprise Environmental Factors

Described in Section 2.1.5. The enterprise environmental factors that influence the Plan Cost Management process include, but are not limited to:

- Organizational culture and structure can all influence cost management;
- Market conditions describe what products, services, and results are available in the regional and global market;
- Currency exchange rates for project costs sourced from more than one country;
- Published commercial information such as resource cost rate information is often available from commercial databases that track skills and human resource costs, and provide standard costs for material and equipment. Published seller price lists are another source of information; and
- Project management information system, which provides alternative possibilities for managing cost.

7.1.1.4 Organizational Process Assets

Described in Section 2.1.4. The organizational process assets that influence the Plan Cost Management process include, but are not limited to:

- Financial controls procedures (e.g., time reporting, required expenditure and disbursement reviews, accounting codes, and standard contract provisions);
- Historical information and lessons learned knowledge bases;
- Financial databases; and
- Existing formal and informal cost estimating and budgeting-related policies, procedures, and guidelines.

7.1.2 Plan Cost Management: Tools and Techniques

7.1.2.1 Expert Judgment

Expert judgment, guided by historical information, provides valuable insight about the environment and information from prior similar projects. Expert judgment can also suggest whether to combine methods and how to reconcile differences between them.

Judgment based upon expertise in an application area, Knowledge Area, discipline, industry, etc., as appropriate for the activity being performed should be used in developing the cost management plan.

7.1.2.2 Analytical Techniques

Developing the cost management plan may involve choosing strategic options to fund the project such as: self-funding, funding with equity, or funding with debt. The cost management plan may also detail ways to finance project resources such as making, purchasing, renting, or leasing. These decisions, like other financial decisions affecting the project, may affect project schedule and/or risks.

Organizational policies and procedures may influence which financial techniques are employed in these decisions. Techniques may include (but are not limited to): payback period, return on investment, internal rate of return, discounted cash flow, and net present value.

7.1.2.3 Meetings

Project teams may hold planning meetings to develop the cost management plan. Attendees at these meetings may include the project manager, the project sponsor, selected project team members, selected stakeholders, anyone with responsibility for project costs, and others as needed.

7.1.3 Plan Cost Management: Outputs

7.1.3.1 Cost Management Plan

The cost management plan is a component of the project management plan and describes how the project costs will be planned, structured, and controlled. The cost management processes and their associated tools and techniques are documented in the cost management plan.

For example, the cost management plan can establish the following:

- **Units of measure.** Each unit used in measurements (such as staff hours, staff days, weeks for time measures; or meters, liters, tons, kilometers, or cubic yards for quantity measures; or lump sum in currency form) is defined for each of the resources.
- **Level of precision.** The degree to which activity cost estimates will be rounded up or down (e.g., US\$100.49 to US\$100, or US\$995.59 to US\$1,000), based on the scope of the activities and magnitude of the project.
- **Level of accuracy.** The acceptable range (e.g., $\pm 10\%$) used in determining realistic activity cost estimates is specified, and may include an amount for contingencies;
- **Organizational procedures links.** The work breakdown structure (WBS) (Section 5.4) provides the framework for the cost management plan, allowing for consistency with the estimates, budgets, and control of costs. The WBS component used for the project cost accounting is called the control account. Each control account is assigned a unique code or account number(s) that links directly to the performing organization's accounting system.
- **Control thresholds.** Variance thresholds for monitoring cost performance may be specified to indicate an agreed-upon amount of variation to be allowed before some action needs to be taken. Thresholds are typically expressed as percentage deviations from the baseline plan.
- **Rules of performance measurement.** Earned value management (EVM) rules of performance measurement are set. For example, the cost management plan may:
 - Define the points in the WBS at which measurement of control accounts will be performed;
 - Establish the earned value measurement techniques (e.g., weighted milestones, fixed-formula, percent complete, etc.) to be employed; and
 - Specify tracking methodologies and the earned value management computation equations for calculating projected estimate at completion (EAC) forecasts to provide a validity check on the bottom-up EAC.

For more specific information regarding earned value management, refer to the *Practice Standard for Earned Value Management – Second Edition*.

- **Reporting formats.** The formats and frequency for the various cost reports are defined.
- **Process descriptions.** Descriptions of each of the other cost management processes are documented.
- **Additional details.** Additional details about cost management activities include, but are not limited to:
 - Description of strategic funding choices,
 - Procedure to account for fluctuations in currency exchange rates, and
 - Procedure for project cost recording.

7.2 Estimate Costs

Estimate Costs is the process of developing an approximation of the monetary resources needed to complete project activities. The key benefit of this process is that it determines the amount of cost required to complete project work. The inputs, tools and techniques, and outputs of this process are depicted in Figure 7-4. Figure 7-5 depicts the data flow diagram of the process.

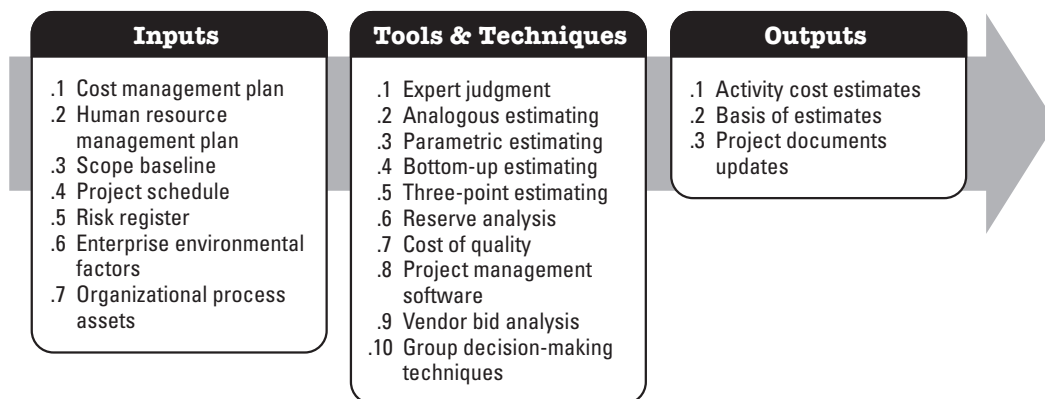

Figure 7-4. Estimate Costs: Inputs, Tools & Techniques, and Outputs

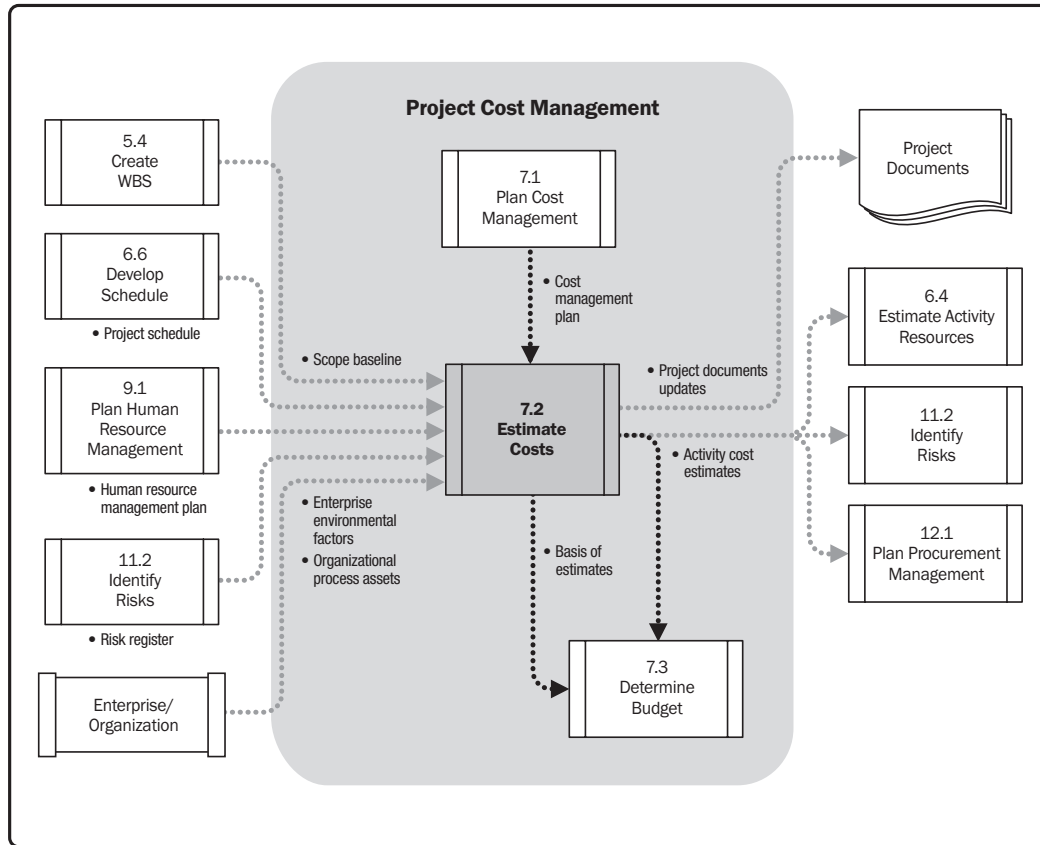

Figure 7-5. Estimate Costs Data Flow Diagram

Cost estimates are a prediction that is based on the information known at a given point in time. Cost estimates include the identification and consideration of costing alternatives to initiate and complete the project. Cost trade-offs and risks should be considered, such as make versus buy, buy versus lease, and the sharing of resources in order to achieve optimal costs for the project.

Cost estimates are generally expressed in units of some currency (i.e., dollars, euros, yen, etc.), although in some instances other units of measure, such as staff hours or staff days, are used to facilitate comparisons by eliminating the effects of currency fluctuations.

Cost estimates should be reviewed and refined during the course of the project to reflect additional detail as it becomes available and assumptions are tested. The accuracy of a project estimate will increase as the project progresses through the project life cycle. For example, a project in the initiation phase may have a rough order of magnitude (ROM) estimate in the range of -25% to $+75\%$. Later in the project, as more information is known, definitive estimates could narrow the range of accuracy to -5% to $+10\%$. In some organizations, there are guidelines for when such refinements can be made and the degree of confidence or accuracy that is expected.

Sources of input information are derived from the outputs of processes in other Knowledge Areas. Once received, all of this information will remain available as inputs to all of the cost management processes.

Costs are estimated for all resources that will be charged to the project. This includes, but is not limited to, labor, materials, equipment, services, and facilities, as well as special categories such as an inflation allowance, cost of financing, or contingency costs. A cost estimate is a quantitative assessment of the likely costs for resources required to complete the activity. Cost estimates may be presented at the activity level or in summary form.

7.2.1 Estimate Costs: Inputs

7.2.1.1 Cost Management Plan

Described in Section 7.1.3.1. The cost management plan defines how project costs will be managed and controlled. It includes the method used and the level of accuracy required to estimate activity cost.

7.2.1.2 Human Resource Management Plan

Described in Section 9.1.3.1. The human resource management plan provides project staffing attributes, personnel rates, and related rewards/recognition, which are necessary components for developing the project cost estimates.

7.2.1.3 Scope Baseline

The scope baseline is comprised of the following:

- **Project scope statement.** The project scope statement (Section 5.3.3.1) provides the product description, acceptance criteria, key deliverables, project boundaries, assumptions, and constraints about the project. One basic assumption that needs to be made when estimating project costs is whether the estimates will be limited to direct project costs only or whether the estimates will also include indirect costs. Indirect costs are those costs that cannot be directly traced to a specific project and therefore will be accumulated and allocated equitably over multiple projects by some approved and documented accounting procedure. One of the most common constraints for many projects is a limited project budget. Examples of other constraints are required delivery dates, available skilled resources, and organizational policies.
- **Work breakdown structure.** The WBS (Section 5.4) provides the relationships among all the components of the project and the project deliverables.
- **WBS dictionary.** The WBS dictionary (Section 5.4.3.1) provides detailed information about the deliverables and a description of the work for each component in the WBS required to produce each deliverable.

Additional information that may be found in the scope baseline with contractual and legal implications, such as health, safety, security, performance, environmental, insurance, intellectual property rights, licenses, and permits. All of this information should be considered when developing the cost estimates.

7.2.1.4 Project Schedule

Described in Section 6.6.3.2. The type and quantity of resources and the amount of time which those resources are applied to complete the work of the project are major factors in determining the project cost. Schedule activity resources and their respective durations are used as key inputs to this process. Estimate Activity Resources (Section 6.4) involves determining the availability of staff, the number of staff hours required, and quantities of material and equipment needed to perform schedule activities. It is closely coordinated with cost estimating. Activity duration estimates (Section 6.5.3.1) will affect cost estimates on any project where the project budget includes an allowance for the cost of financing (including interest charges) and where resources are applied per unit of time for the duration of the activity. Activity duration estimates can also affect cost estimates that have time-sensitive costs included in them, such as union labor with regularly expiring collective bargaining agreements or materials with seasonal cost variations.

7.2.1.5 Risk Register

Described in Section 11.2.3.1. The risk register should be reviewed to consider risk response costs. Risks, which can be either threats or opportunities, typically have an impact on both activity and overall project costs. As a general rule, when the project experiences a negative risk event, the near-term cost of the project will usually increase, and there will sometimes be a delay in the project schedule. In a similar way, the project team should be sensitive to potential opportunities that can benefit the business either by directly reducing activity costs or by accelerating the schedule.

7.2.1.6 Enterprise Environmental Factors

Described in Section 2.1.5. The enterprise environmental factors that influence the Estimate Costs process include, but are not limited to:

- **Market conditions.** These conditions describe what products, services, and results are available in the market, from whom, and under what terms and conditions. Regional and/or global supply and demand conditions greatly influence resource costs.

- **Published commercial information.** Resource cost rate information is often available from commercial databases that track skills and human resource costs, and provide standard costs for material and equipment. Published seller price lists are another source of information.

7.2.1.7 Organizational Process Assets

Described in Section 2.1.4. The organizational process assets that influence the Estimate Costs process include, but are not limited to:

- Cost estimating policies,
- Cost estimating templates,
- Historical information, and
- Lessons learned.

7.2.2 Estimate Costs: Tools and Techniques

7.2.2.1 Expert Judgment

Expert judgment, guided by historical information, provides valuable insight about the environment and information from prior similar projects. Expert judgment can also be used to determine whether to combine methods of estimating and how to reconcile differences between them.

7.2.2.2 Analogous Estimating

Analogous cost estimating uses the values such as scope, cost, budget, and duration or measures of scale such as size, weight, and complexity from a previous, similar project as the basis for estimating the same parameter or measurement for a current project. When estimating costs, this technique relies on the actual cost of previous, similar projects as the basis for estimating the cost of the current project. It is a gross value estimating approach, sometimes adjusted for known differences in project complexity.

Analogous cost estimating is frequently used to estimate a value when there is a limited amount of detailed information about the project, for example, in the early phases of a project. Analogous cost estimating uses historical information and expert judgment.

Analogous cost estimating is generally less costly and less time consuming than other techniques, but it is also generally less accurate. Analogous cost estimates can be applied to a total project or to segments of a project, in conjunction with other estimating methods. Analogous estimating is most reliable when the previous projects are similar in fact and not just in appearance, and the project team members preparing the estimates have the needed expertise.

7.2.2.3 Parametric Estimating

Parametric estimating uses a statistical relationship between relevant historical data and other variables (e.g., square footage in construction) to calculate a cost estimate for project work. This technique can produce higher levels of accuracy depending upon the sophistication and underlying data built into the model. Parametric cost estimates can be applied to a total project or to segments of a project, in conjunction with other estimating methods.

7.2.2.4 Bottom-Up Estimating

Bottom-up estimating is a method of estimating a component of work. The cost of individual work packages or activities is estimated to the greatest level of specified detail. The detailed cost is then summarized or “rolled up” to higher levels for subsequent reporting and tracking purposes. The cost and accuracy of bottom-up cost estimating are typically influenced by the size and complexity of the individual activity or work package.

7.2.2.5 Three-Point Estimating

The accuracy of single-point activity cost estimates may be improved by considering estimation uncertainty and risk and using three estimates to define an approximate range for an activity’s cost:

- **Most likely** (*cM*). The cost of the activity, based on realistic effort assessment for the required work and any predicted expenses.
- **Optimistic** (*cO*). The activity cost based on analysis of the best-case scenario for the activity.
- **Pessimistic** (*cP*). The activity cost based on analysis of the worst-case scenario for the activity.

Depending on the assumed distribution of values within the range of the three estimates the expected cost, cE , can be calculated using a formula. Two commonly used formulas are triangular and beta distributions. The formulas are:

- **Triangular Distribution.** $cE = (cO + cM + cP) / 3$
- **Beta Distribution** (from a traditional PERT analysis). $cE = (cO + 4cM + cP) / 6$

Cost estimates based on three points with an assumed distribution provide an expected cost and clarify the range of uncertainty around the expected cost.

7.2.2.6 Reserve Analysis

Cost estimates may include contingency reserves (sometimes called contingency allowances) to account for cost uncertainty. Contingency reserves are the budget within the cost baseline that is allocated for identified risks, which are accepted and for which contingent or mitigating responses are developed. Contingency reserves are often viewed as the part of the budget intended to address the “known-unknowns” that can affect a project. For example, rework for some project deliverables could be anticipated, while the amount of this rework is unknown. Contingency reserves may be estimated to account for this unknown amount of rework. Contingency reserves can provide for a specific activity, for the whole project, or both. The contingency reserve may be a percentage of the estimated cost, a fixed number, or may be developed by using quantitative analysis methods.

As more precise information about the project becomes available, the contingency reserve may be used, reduced, or eliminated. Contingency should be clearly identified in cost documentation. Contingency reserves are part of the cost baseline and the overall funding requirements for the project.

Estimates may also be produced for the amount of management reserve to be funded for the project. Management reserves are an amount of the project budget withheld for management control purposes and are reserved for unforeseen work that is within scope of the project. Management reserves are intended to address the “unknown unknowns” that can affect a project. The management reserve is not included in the cost baseline but is part of the overall project budget and funding requirements. When an amount of management reserves is used to fund unforeseen work, the amount of management reserve used is added to the cost baseline, thus requiring an approved change to the cost baseline.

7.2.2.7 Cost of Quality (COQ)

Assumptions about costs of quality (Section 8.1.2.2) may be used to prepare the activity cost estimate.

7.2.2.8 Project Management Software

Project management software applications, computerized spreadsheets, simulation, and statistical tools are used to assist with cost estimating. Such tools can simplify the use of some cost-estimating techniques and thereby facilitate rapid consideration of cost estimate alternatives.

7.2.2.9 Vendor Bid Analysis

Cost estimating methods may include analysis of what the project should cost, based on the responsive bids from qualified vendors. When projects are awarded to a vendor under competitive processes, additional cost estimating work may be required of the project team to examine the price of individual deliverables and to derive a cost that supports the final total project cost.

7.2.2.10 Group Decision-Making Techniques

Team-based approaches, such as brainstorming, the Delphi or nominal group techniques, are useful for engaging team members to improve estimate accuracy and commitment to the emerging estimates. By involving a structured group of people who are close to the technical execution of work in the estimation process, additional information is gained and more accurate estimates are obtained. Additionally, when people are involved in the estimation process, their commitment towards meeting the resulting estimates increases.

7.2.3 Estimate Costs: Outputs

7.2.3.1 Activity Cost Estimates

Activity cost estimates are quantitative assessments of the probable costs required to complete project work. Cost estimates can be presented in summary form or in detail. Costs are estimated for all resources that are applied to the activity cost estimate. This includes, but is not limited to, direct labor, materials, equipment, services, facilities, information technology, and special categories such as cost of financing (including interest charges), an inflation allowance, exchange rates, or a cost contingency reserve. Indirect costs, if they are included in the project estimate, can be included at the activity level or at higher levels.

7.2.3.2 Basis of Estimates

The amount and type of additional details supporting the cost estimate vary by application area. Regardless of the level of detail, the supporting documentation should provide a clear and complete understanding of how the cost estimate was derived.

Supporting detail for activity cost estimates may include:

- Documentation of the basis of the estimate (i.e., how it was developed),
- Documentation of all assumptions made,
- Documentation of any known constraints,
- Indication of the range of possible estimates (e.g., €10,000 (±10%) to indicate that the item is expected to cost between a range of values), and
- Indication of the confidence level of the final estimate.

7.2.3.3 Project Documents Updates

Project documents that may be updated include, but are not limited to, the risk register.

7.3 Determine Budget

Determine Budget is the process of aggregating the estimated costs of individual activities or work packages to establish an authorized cost baseline. The key benefit of this process is that it determines the cost baseline against which project performance can be monitored and controlled. The inputs, tools and techniques, and outputs of this process are depicted in Figure 7-6. Figure 7-7 depicts the data flow diagram of the process.

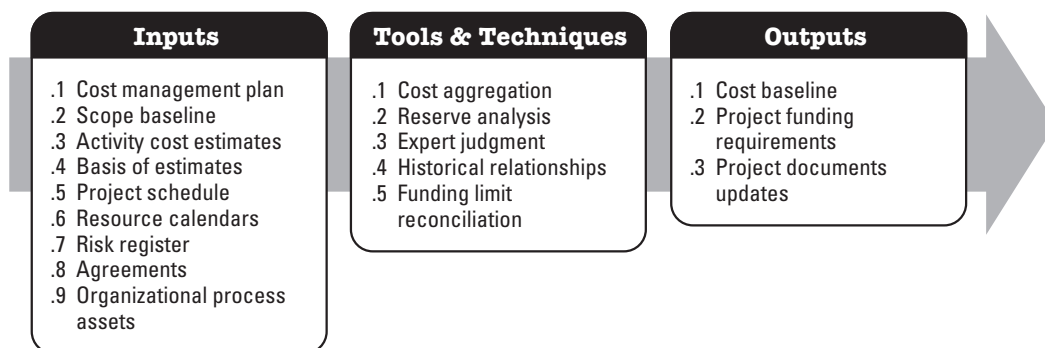

Figure 7-6. Determine Budget: Inputs, Tools & Techniques, and Outputs

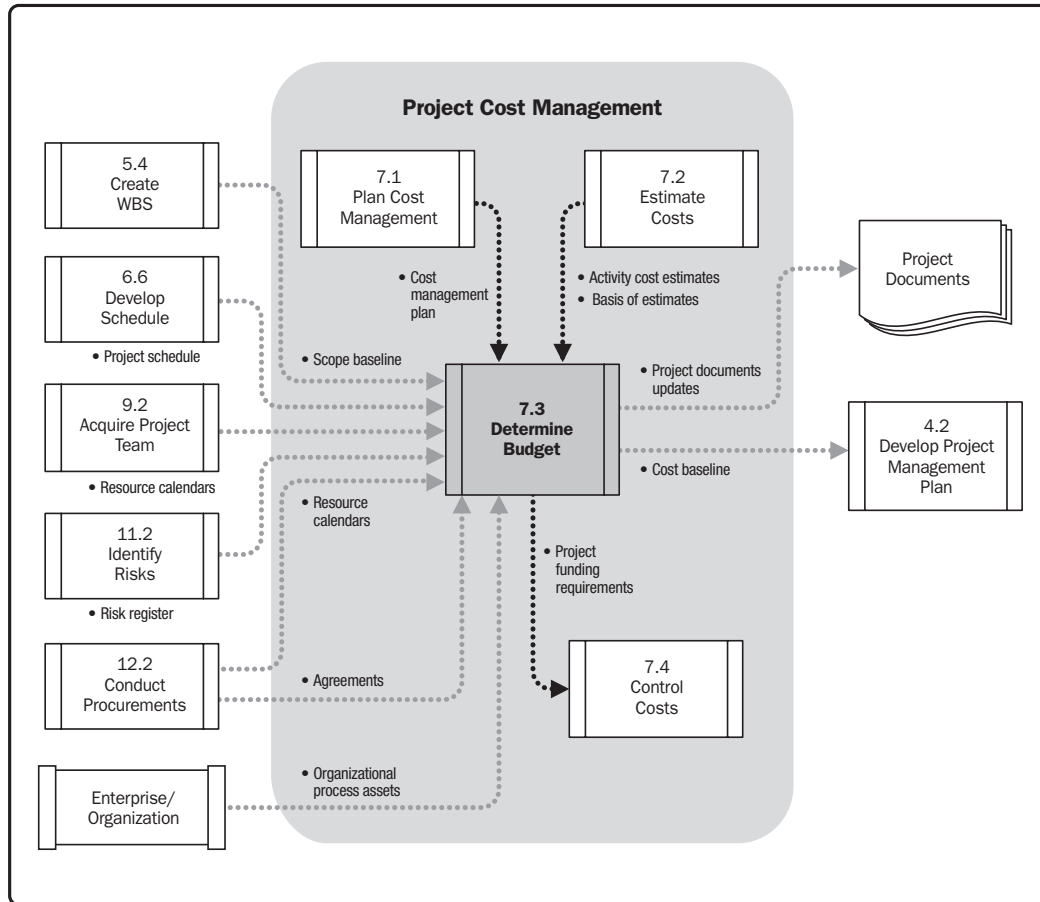

Figure 7-7. Determine Budget Data Flow Diagram

A project budget includes all the funds authorized to execute the project. The cost baseline is the approved version of the time-phased project budget, but excludes management reserves.

7.3.1 Determine Budget: Inputs

7.3.1.1 Cost Management Plan

Described in Section 7.1.3.1. The cost management plan describes how the project costs will be managed and controlled.

7.3.1.2 Scope Baseline

- **Project scope statement.** Formal limitations by period for the expenditure of project funds can be mandated by the organization, by agreement (Section 12.2.3.2), or by other entities such as government agencies. These funding constraints are reflected in the project scope statement.
- **Work breakdown structure.** The WBS (Section 5.4) provides the relationships among all the project deliverables and their various components.
- **WBS dictionary.** The WBS dictionary (Section 5.4.3.1) and related detailed statements of work provide an identification of the deliverables and a description of the work in each WBS component required to produce each deliverable.

7.3.1.3 Activity Cost Estimates

Described in Section 7.2.3.1. Cost estimates for each activity within a work package are aggregated to obtain a cost estimate for each work package.

7.3.1.4 Basis of Estimates

Described in Section 7.2.3.2. Supporting detail for cost estimates contained in the basis for estimates should specify any basic assumptions dealing with the inclusion or exclusion of indirect or other costs in the project budget.

7.3.1.5 Project Schedule

Described in Section 6.6.3.2. The project schedule includes planned start and finish dates for the project's activities, milestones, work packages, and control accounts. This information can be used to aggregate costs to the calendar periods in which the costs are planned to be incurred.

7.3.1.6 Resource Calendars

Described in Sections 9.2.3.2 and 12.2.3.3. Resource calendars provide information on which resources are assigned to the project and when they are assigned. This information can be used to indicate resource costs over the duration of the project.

7.3.1.7 Risk Register

Described in Section 11.2.3.1. The risk register should be reviewed to consider how to aggregate the risk response costs. Updates to the risk register are included with project document updates described in Section 11.5.3.2.

7.3.1.8 Agreements

Described in Section 12.2.3.2. Applicable agreement information and costs relating to products, services, or results that have been or will be purchased are included when determining the budget.

7.3.1.9 Organizational Process Assets

Described in Section 2.1.4. The organizational process assets that influence the Determine Budget process include, but are not limited to:

- Existing formal and informal cost budgeting-related policies, procedures, and guidelines;
- Cost budgeting tools; and
- Reporting methods.

7.3.2 Determine Budget: Tools and Techniques

7.3.2.1 Cost Aggregation

Cost estimates are aggregated by work packages in accordance with the WBS. The work package cost estimates are then aggregated for the higher component levels of the WBS (such as control accounts) and ultimately for the entire project.

7.3.2.2 Reserve Analysis

Budget reserve analysis can establish both the contingency reserves and the management reserves for the project. Management and contingency reserves are addressed in more detail in Section 7.2.2.6.

7.3.2.3 Expert Judgment

Expert judgment, guided by experience in an application area, Knowledge Area, discipline, industry, or similar project, aids in determining the budget. Such expertise may be provided by any group or person with specialized education, knowledge, skill, experience, or training. Expert judgment is available from many sources, including, but not limited to:

- Other units within the performing organization,
- Consultants,
- Stakeholders, including customers,
- Professional and technical associations, and
- Industry groups.

7.3.2.4 Historical Relationships

Any historical relationships that result in parametric estimates or analogous estimates involve the use of project characteristics (parameters) to develop mathematical models to predict total project costs. Such models may be simple (e.g., residential home construction is based on a certain cost per square foot of space) or complex (e.g., one model of software development costing uses multiple separate adjustment factors, each of which has numerous points within it).

Both the cost and accuracy of analogous and parametric models can vary widely. They are most likely to be reliable when:

- Historical information used to develop the model is accurate,
- Parameters used in the model are readily quantifiable, and
- Models are scalable, such that they work for large projects, small projects, and phases of a project.

7.3.2.5 Funding Limit Reconciliation

The expenditure of funds should be reconciled with any funding limits on the commitment of funds for the project. A variance between the funding limits and the planned expenditures will sometimes necessitate the rescheduling of work to level out the rate of expenditures. This is accomplished by placing imposed date constraints for work into the project schedule.

7.3.3 Determine Budget: Outputs

7.3.3.1 Cost Baseline

The cost baseline is the approved version of the time-phased project budget, excluding any management reserves, which can only be changed through formal change control procedures and is used as a basis for comparison to actual results. It is developed as a summation of the approved budgets for the different schedule activities.

Figure 7-8 illustrates the various components of the project budget and cost baseline. Activity cost estimates for the various project activities along with any contingency reserves (Section 7.2.2.6) for these activities are aggregated into their associated work package costs. The work package cost estimates, along with any contingency reserves estimated for the work packages, are aggregated into control accounts. The summation of the control accounts make up the cost baseline. Since the cost estimates that make up the cost baseline are directly tied to the schedule activities, this enables a time-phased view of the cost baseline, which is typically displayed in the form of an S-curve, as is illustrated in Figure 7-9.

Management reserves (Section 7.2.2.6) are added to the cost baseline to produce the project budget. As changes warranting the use of management reserves arise, the change control process is used to obtain approval to move the applicable management reserve funds into the cost baseline.

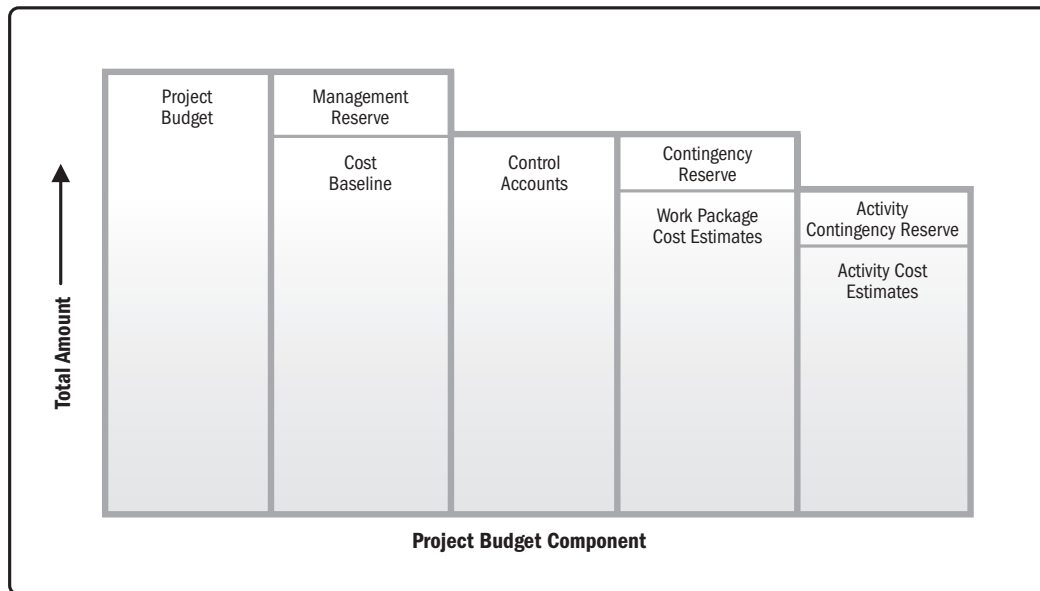

Figure 7-8. Project Budget Components

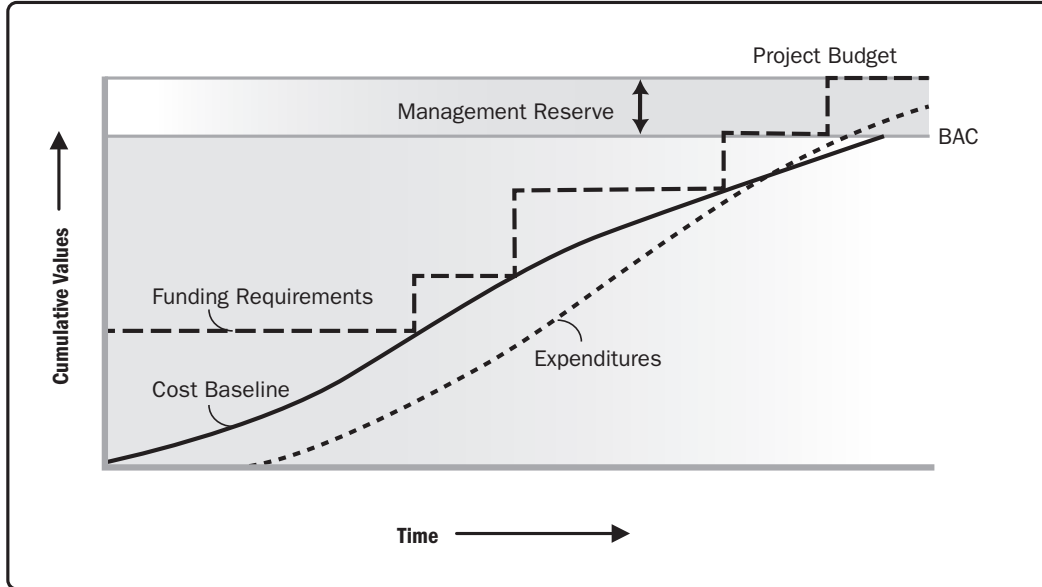

Figure 7-9. Cost Baseline, Expenditures, and Funding Requirements

7.3.3.2 Project Funding Requirements

Total funding requirements and periodic funding requirements (e.g., quarterly, annually) are derived from the cost baseline. The cost baseline will include projected expenditures plus anticipated liabilities. Funding often occurs in incremental amounts that are not continuous, and may not be evenly distributed, which appear as steps as shown in Figure 7-9. The total funds required are those included in the cost baseline, plus management reserves, if any. Funding requirements may include the source(s) of the funding.

7.3.3.3 Project Documents Updates

Project documents that may be updated include, but are not limited to:

- Risk register,
- Activity cost estimates, and
- Project schedule.

7.4 Control Costs

Control Costs is the process of monitoring the status of the project to update the project costs and managing changes to the cost baseline. The key benefit of this process is that it provides the means to recognize variance from the plan in order to take corrective action and minimize risk. The inputs, tools and techniques, and outputs of this process are depicted in Figure 7-10. Figure 7-11 depicts the data flow diagram of the process.

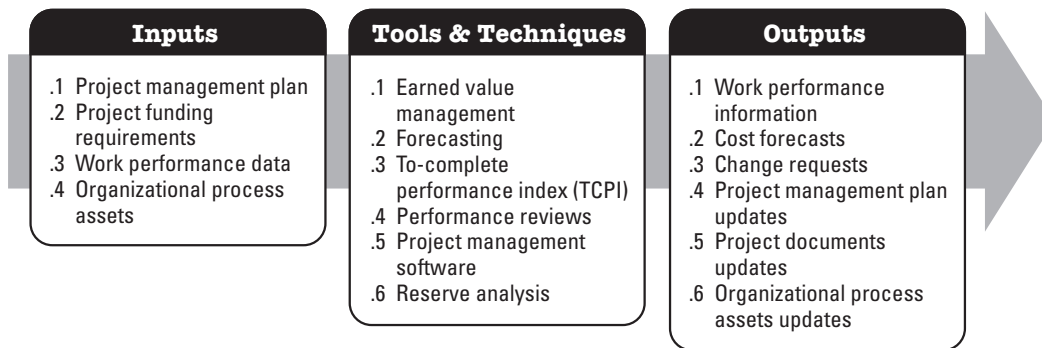

Figure 7-10. Control Costs: Inputs, Tools & Techniques, and Outputs

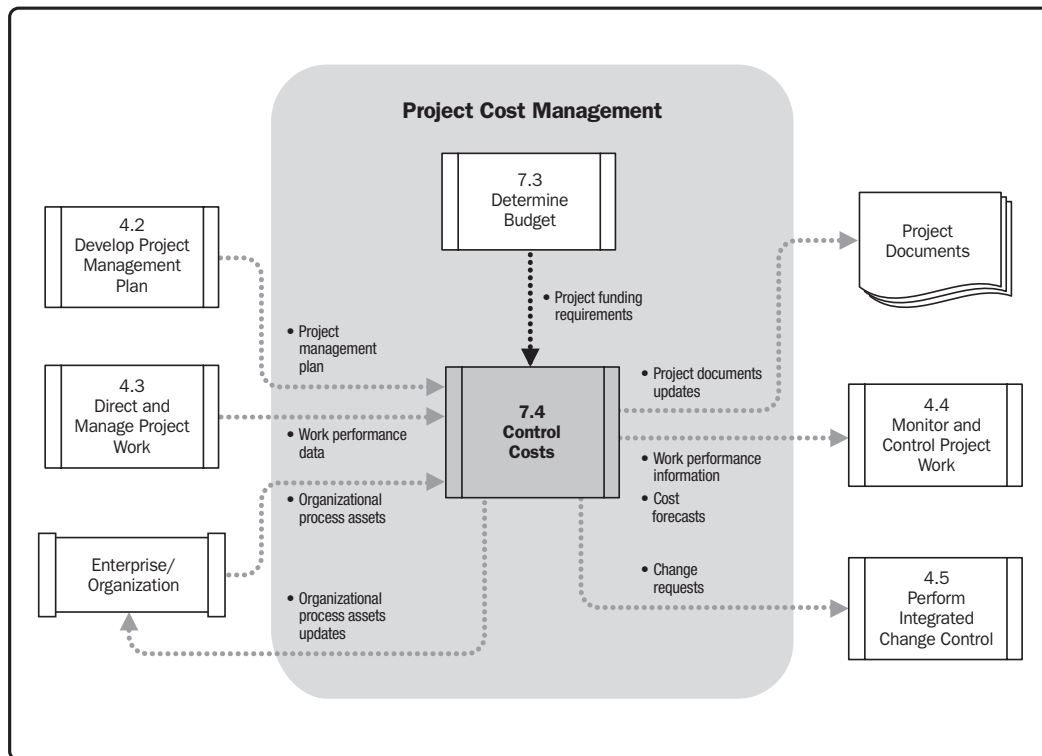

Figure 7-11. Control Costs Data Flow Diagram

Updating the budget requires knowledge of the actual costs spent to date. Any increase to the authorized budget can only be approved through the Perform Integrated Change Control process (Section 4.5). Monitoring the expenditure of funds without regard to the value of work being accomplished for such expenditures has little value to the project, other than to allow the project team to stay within the authorized funding. Much of the effort of cost control involves analyzing the relationship between the consumption of project funds to the physical work being accomplished for such expenditures. The key to effective cost control is the management of the approved cost baseline and the changes to that baseline.

Project cost control includes:

- Influencing the factors that create changes to the authorized cost baseline;
- Ensuring that all change requests are acted on in a timely manner;
- Managing the actual changes when and as they occur;
- Ensuring that cost expenditures do not exceed the authorized funding by period, by WBS component, by activity, and in total for the project;
- Monitoring cost performance to isolate and understand variances from the approved cost baseline;
- Monitoring work performance against funds expended;
- Preventing unapproved changes from being included in the reported cost or resource usage;
- Informing appropriate stakeholders of all approved changes and associated cost; and
- Bringing expected cost overruns within acceptable limits.

7.4.1 Control Costs: Inputs

7.4.1.1 Project Management Plan

Described in Section 4.2.3.1. The project management plan contains the following information that is used to control cost:

- **Cost baseline.** The cost baseline is compared with actual results to determine if a change, corrective action, or preventive action is necessary.
- **Cost management plan.** The cost management plan describes how the project costs will be managed and controlled (Section 7.1.3.1).

7.4.1.2 Project Funding Requirements

Described in Section 7.3.3.2. The project funding requirements include projected expenditures plus anticipated liabilities.

7.4.1.3 Work Performance Data

Described in Section 4.3.3.2. Work performance data includes information about project progress, such as which activities have started, their progress, and which deliverables have finished. Information also includes costs that have been authorized and incurred.

7.4.1.4 Organizational Process Assets

Described in Section 2.1.4. The organizational process assets that can influence the Control Costs process include, but are not limited to:

- Existing formal and informal cost control-related policies, procedures, and guidelines;
- Cost control tools; and
- Monitoring and reporting methods to be used.

7.4.2 Control Costs: Tools and Techniques

7.4.2.1 Earned Value Management

Earned value management (EVM) is a methodology that combines scope, schedule, and resource measurements to assess project performance and progress. It is a commonly used method of performance measurement for projects. It integrates the scope baseline with the cost baseline, along with the schedule baseline, to form the performance baseline, which helps the project management team assess and measure project performance and progress. It is a project management technique that requires the formation of an integrated baseline against which performance can be measured for the duration of the project. The principles of EVM can be applied to all projects in any industry. EVM develops and monitors three key dimensions for each work package and control account:

- **Planned value.** Planned value (PV) is the authorized budget assigned to scheduled work. It is the authorized budget planned for the work to be accomplished for an activity or work breakdown structure component, not including management reserve. This budget is allocated by phase over the life of the project, but at a given moment, planned value defines the physical work that should have been accomplished. The total of the PV is sometimes referred to as the performance measurement baseline (PMB). The total planned value for the project is also known as budget at completion (BAC).
- **Earned value.** Earned value (EV) is a measure of work performed expressed in terms of the budget authorized for that work. It is the budget associated with the authorized work that has been completed. The EV being measured needs to be related to the PMB, and the EV measured cannot be greater than the authorized PV budget for a component. The EV is often used to calculate the percent complete of a project. Progress measurement criteria should be established for each WBS component to measure work in progress. Project managers monitor EV, both incrementally to determine current status and cumulatively to determine the long-term performance trends.
- **Actual cost.** Actual cost (AC) is the realized cost incurred for the work performed on an activity during a specific time period. It is the total cost incurred in accomplishing the work that the EV measured. The AC needs to correspond in definition to what was budgeted in the PV and measured in the EV (e.g., direct hours only, direct costs only, or all costs including indirect costs). The AC will have no upper limit; whatever is spent to achieve the EV will be measured.

Variances from the approved baseline will also be monitored:

- **Schedule variance.** Schedule variance (SV) is a measure of schedule performance expressed as the difference between the earned value and the planned value. It is the amount by which the project is ahead or behind the planned delivery date, at a given point in time. It is a measure of schedule performance on a project. It is equal to the earned value (EV) minus the planned value (PV). The EVM schedule variance is a useful metric in that it can indicate when a project is falling behind or is ahead of its baseline schedule. The EVM schedule variance will ultimately equal zero when the project is completed because all of the planned values will have been earned. Schedule variance is best used in conjunction with critical path methodology (CPM) scheduling and risk management. *Equation: $SV = EV - PV$*
- **Cost variance.** Cost variance (CV) is the amount of budget deficit or surplus at a given point in time, expressed as the difference between earned value and the actual cost. It is a measure of cost performance on a project. It is equal to the earned value (EV) minus the actual cost (AC). The cost variance at the end of the project will be the difference between the budget at completion (BAC) and the actual amount spent. The CV is particularly critical because it indicates the relationship of physical performance to the costs spent. Negative CV is often difficult for the project to recover. *Equation: $CV = EV - AC$*

The SV and CV values can be converted to efficiency indicators to reflect the cost and schedule performance of any project for comparison against all other projects or within a portfolio of projects. The variances are useful for determining project status.

- Schedule performance index.** The schedule performance index (SPI) is a measure of schedule efficiency expressed as the ratio of earned value to planned value. It measures how efficiently the project team is using its time. It is sometimes used in conjunction with the cost performance index (CPI) to forecast the final project completion estimates. An SPI value less than 1.0 indicates less work was completed than was planned. An SPI greater than 1.0 indicates that more work was completed than was planned. Since the SPI measures all project work, the performance on the critical path also needs to be analyzed to determine whether the project will finish ahead of or behind its planned finish date. The SPI is equal to the ratio of the EV to the PV. Equation: $SPI = EV/PV$
- Cost performance index.** The cost performance index (CPI) is a measure of the cost efficiency of budgeted resources, expressed as a ratio of earned value to actual cost. It is considered the most critical EVM metric and measures the cost efficiency for the work completed. A CPI value of less than 1.0 indicates a cost overrun for work completed. A CPI value greater than 1.0 indicates a cost underrun of performance to date. The CPI is equal to the ratio of the EV to the AC. The indices are useful for determining project status and providing a basis for estimating project cost and schedule outcome. Equation: $CPI = EV/AC$

The three parameters of planned value, earned value, and actual cost can be monitored and reported on both a period-by-period basis (typically weekly or monthly) and on a cumulative basis. Figure 7-12 uses S-curves to display EV data for a project that is performing over budget and behind the schedule.

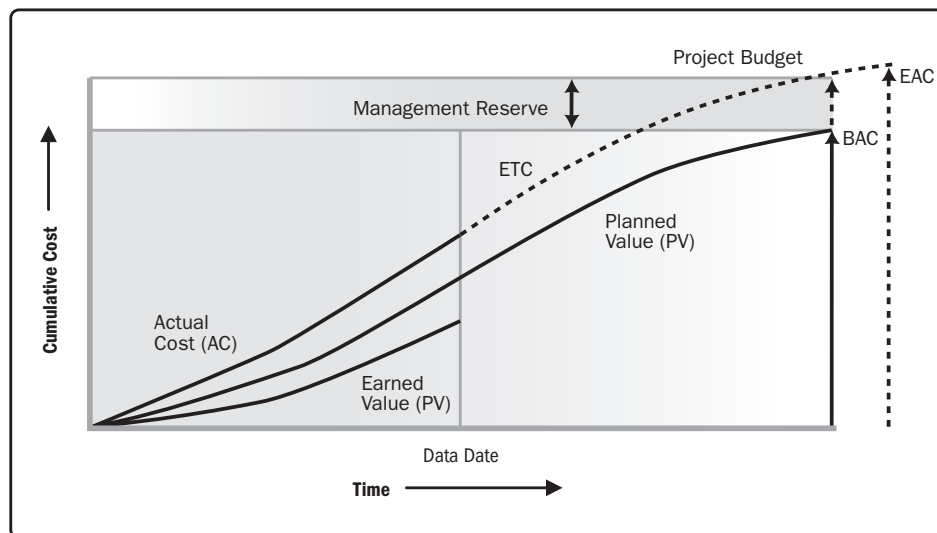

Figure 7-12. Earned Value, Planned Value, and Actual Costs

7.4.2.2 Forecasting

As the project progresses, the project team may develop a forecast for the estimate at completion (EAC) that may differ from the budget at completion (BAC) based on the project performance. If it becomes obvious that the BAC is no longer viable, the project manager should consider the forecasted EAC. Forecasting the EAC involves making projections of conditions and events in the project's future based on current performance information and other knowledge available at the time of the forecast. Forecasts are generated, updated, and reissued based on work performance data (Section 4.3.3.2) that is provided as the project is executed. The work performance information covers the project's past performance and any information that could impact the project in the future.

EACs are typically based on the actual costs incurred for work completed, plus an estimate to complete (ETC) the remaining work. It is incumbent on the project team to predict what it may encounter to perform the ETC, based on its experience to date. The EVM method works well in conjunction with manual forecasts of the required EAC costs. The most common EAC forecasting approach is a manual, bottom-up summation by the project manager and project team.

The project manager's bottom-up EAC method builds upon the actual costs and experience incurred for the work completed, and requires a new estimate to complete the remaining project work. Equation: $EAC = AC + \text{Bottom-up ETC}$.

The project manager's manual EAC is quickly compared with a range of calculated EACs representing various risk scenarios. When calculating EAC values, the cumulative CPI and SPI values are typically used. While EVM data quickly provide many statistical EACs, only three of the more common methods are described as follows:

- **EAC forecast for ETC work performed at the budgeted rate.** This EAC method accepts the actual project performance to date (whether favorable or unfavorable) as represented by the actual costs, and predicts that all future ETC work will be accomplished at the budgeted rate. When actual performance is unfavorable, the assumption that future performance will improve should be accepted only when supported by project risk analysis. *Equation:* $EAC = AC + (BAC - EV)$
- **EAC forecast for ETC work performed at the present CPI.** This method assumes what the project has experienced to date can be expected to continue in the future. The ETC work is assumed to be performed at the same cumulative cost performance index (CPI) as that incurred by the project to date. *Equation:* $EAC = BAC / CPI$

- **EAC forecast for ETC work considering both SPI and CPI factors.** In this forecast, the ETC work will be performed at an efficiency rate that considers both the cost and schedule performance indices. This method is most useful when the project schedule is a factor impacting the ETC effort. Variations of this method weight the CPI and SPI at different values (e.g., 80/20, 50/50, or some other ratio) according to the project manager's judgment. *Equation:* $EAC = AC + [(BAC - EV) / (CPI \times SPI)]$

Each of these approaches is applicable for any given project and will provide the project management team with an “early warning” signal if the EAC forecasts are not within acceptable tolerances.

7.4.2.3 To-Complete Performance Index (TCPI)

The to-complete performance index (TCPI) is a measure of the cost performance that is required to be achieved with the remaining resources in order to meet a specified management goal, expressed as the ratio of the cost to finish the outstanding work to the remaining budget. TCPI is the calculated cost performance index that is achieved on the remaining work to meet a specified management goal, such as the BAC or the EAC. If it becomes obvious that the BAC is no longer viable, the project manager should consider the forecasted EAC. Once approved, the EAC may replace the BAC in the TCPI calculation. The equation for the TCPI based on the BAC: $(BAC - EV) / (BAC - AC)$.

The TCPI is conceptually displayed in Figure 7-13. The equation for the TCPI is shown in the lower left as the work remaining (defined as the BAC minus the EV) divided by the funds remaining (which can be either the BAC minus the AC, or the EAC minus the AC).

If the cumulative CPI falls below the baseline (as shown in Figure 7-13), all future work of the project will need to be performed immediately in the range of the TCPI (BAC) (as reflected in the top line of Figure 7-13) to stay within the authorized BAC. Whether this level of performance is achievable is a judgment call based on a number of considerations, including risk, schedule, and technical performance. This level of performance is displayed as the TCPI (EAC) line. The equation for the TCPI based on the EAC: $(BAC - EV) / (EAC - AC)$. The EVM formulas are provided in Table 7-1.

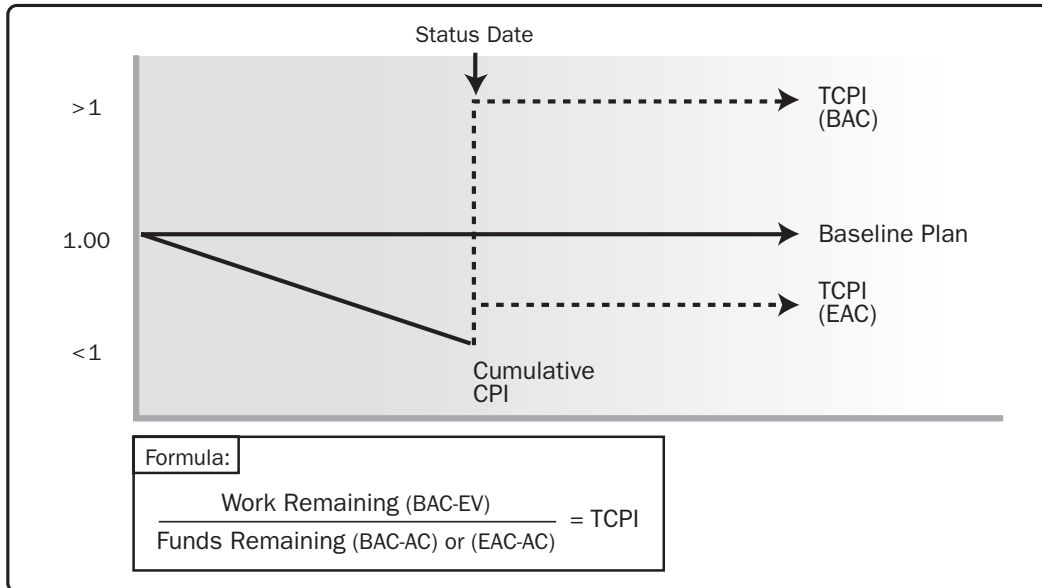

Figure 7-13. To-Complete Performance Index (TCPI)

7.4.2.4 Performance Reviews

Performance reviews compare cost performance over time, schedule activities or work packages overrunning and underrunning the budget, and estimated funds needed to complete work in progress. If EVM is being used, the following information is determined:

- Variance analysis.** Variance analysis, as used in EVM, is the explanation (cause, impact, and corrective actions) for cost ($CV = EV - AC$), schedule ($SV = EV - PV$), and variance at completion ($VAC = BAC - EAC$) variances. Cost and schedule variances are the most frequently analyzed measurements. For projects not using earned value management, similar variance analyses can be performed by comparing planned activity cost against actual activity cost to identify variances between the cost baseline and actual project performance. Further analysis can be performed to determine the cause and degree of variance relative to the schedule baseline and any corrective or preventative actions needed. Cost performance measurements are used to assess the magnitude of variation to the original cost baseline. An important aspect of project cost control includes determining the cause and degree of variance relative to the cost baseline (Section 7.3.3.1) and deciding whether corrective or preventive action is required. The percentage range of acceptable variances will tend to decrease as more work is accomplished.

- **Trend analysis.** Trend analysis examines project performance over time to determine if performance is improving or deteriorating. Graphical analysis techniques are valuable for understanding performance to date and for comparison to future performance goals in the form of BAC versus EAC and completion dates.
- **Earned value performance.** Earned value performance compares the performance measurement baseline to actual schedule and cost performance. If EVM is not being used, then the analysis of the cost baseline against actual costs for the work performed is used for cost performance comparisons.

Table 7-1. Earned Value Calculations Summary Table

Earned Value Analysis					
Abbreviation	Name	Lexicon Definition	How Used	Equation	Interpretation of Result
PV	Planned Value	The authorized budget assigned to scheduled work.	The value of the work planned to be completed to a point in time, usually the data date, or project completion.		
EV	Earned Value	The measure of work performed expressed in terms of the budget authorized for that work.	The planned value of all the work completed (earned) to a point in time, usually the data date, without reference to actual costs.	$EV = \text{sum of the planned value of completed work}$	
AC	Actual Cost	The realized cost incurred for the work performed on an activity during a specific time period.	The actual cost of all the work completed to a point in time, usually the data date.		
BAC	Budget at Completion	The sum of all budgets established for the work to be performed.	The value of total planned work, the project cost baseline.		
CV	Cost Variance	The amount of budget deficit or surplus at a given point in time, expressed as the difference between the earned value and the actual cost.	The difference between the value of work completed to a point in time, usually the data date, and the actual costs to the same point in time.	$CV = EV - AC$	Positive = Under planned cost Neutral = On planned cost Negative = Over planned cost
SV	Schedule Variance	The amount by which the project is ahead or behind the planned delivery date, at a given point in time, expressed as the difference between the earned value and the planned value.	The difference between the work completed to a point in time, usually the data date, and the work planned to be completed to the same point in time.	$SV = EV - PV$	Positive = Ahead of Schedule Neutral = On schedule Negative = Behind Schedule
VAC	Variance at Completion	A projection of the amount of budget deficit or surplus, expressed as the difference between the budget at completion and the estimate at completion.	The estimated difference in cost at the completion of the project.	$VAC = BAC - EAC$	Positive = Under planned cost Neutral = On planned cost Negative = Over planned cost
CPI	Cost Performance Index	A measure of the cost efficiency of budgeted resources expressed as the ratio of earned value to actual cost.	A CPI of 1.0 means the project is exactly on budget, that the work actually done so far is exactly the same as the cost so far. Other values show the percentage of how much costs are over or under the budgeted amount for work accomplished.	$CPI = EV/AC$	Greater than 1.0 = Under planned cost Exactly 1.0 = On planned cost Less than 1.0 = Over planned cost
SPI	Schedule Performance Index	A measure of schedule efficiency expressed as the ratio of earned value to planned value.	An SPI of 1.0 means that the project is exactly on schedule, that the work actually done so far is exactly the same as the work planned to be done so far. Other values show the percentage of how much costs are over or under the budgeted amount for work planned.	$SPI = EV/PV$	Greater than 1.0 = Ahead of schedule Exactly 1.0 = On schedule Less than 1.0 = Behind schedule
EAC	Estimate At Completion	The expected total cost of completing all work expressed as the sum of the actual cost to date and the estimate to complete.	If the CPI is expected to be the same for the remainder of the project, EAC can be calculated using: If future work will be accomplished at the planned rate, use: If the initial plan is no longer valid, use: If both the CPI and SPI influence the remaining work, use:	$EAC = BAC/CPI$ $EAC = AC + BAC - EV$ $EAC = AC + \text{Bottom-up ETC}$ $EAC = AC + [(BAC - EV)/(CPI \times SPI)]$	
ETC	Estimate to Complete	The expected cost to finish all the remaining project work.	Assuming work is proceeding on plan, the cost of completing the remaining authorized work can be calculated using: Reestimate the remaining work from the bottom up.	$ETC = EAC - AC$ $ETC = \text{Reestimate}$	
TCPI	To Complete Performance Index	A measure of the cost performance that must be achieved with the remaining resources in order to meet a specified management goal, expressed as the ratio of the cost to finish the outstanding work to the budget available.	The efficiency that must be maintained in order to complete on plan. The efficiency that must be maintained in order to complete the current EAC.	$TCPI = (BAC - EV)/(BAC - AC)$ $TCPI = (BAC - EV)/(EAC - AC)$	Greater than 1.0 = Harder to complete Exactly 1.0 = Same to complete Less than 1.0 = Easier to complete Greater than 1.0 = Harder to complete Exactly 1.0 = Same to complete Less than 1.0 = Easier to complete

7.4.2.5 Project Management Software

Project management software is often used to monitor the three EVM dimensions (PV, EV, and AC), to display graphical trends, and to forecast a range of possible final project results.

7.4.2.6 Reserve Analysis

During cost control, reserve analysis is used to monitor the status of contingency and management reserves for the project to determine if these reserves are still needed or if additional reserves need to be requested. As work on the project progresses, these reserves may be used as planned to cover the cost of risk mitigation events or other contingencies. Or, if the probable risk events do not occur, the unused contingency reserves may be removed from the project budget to free up resources for other projects or operations. Additional risk analysis during the project may reveal a need to request that additional reserves be added to the project budget. Management and contingency reserves are addressed in more detail in Section 7.2.2.6.

7.4.3 Control Costs: Outputs

7.4.3.1 Work Performance Information

The calculated CV, SV, CPI, SPI, TCPI, and VAC values for WBS components, in particular the work packages and control accounts, are documented and communicated to stakeholders.

7.4.3.2 Cost Forecasts

Either a calculated EAC value or a bottom-up EAC value is documented and communicated to stakeholders.

7.4.3.3 Change Requests

Analysis of project performance may result in a change request to the cost baseline or other components of the project management plan. Change requests may include preventive or corrective actions, and are processed for review and disposition through the Perform Integrated Change Control process (Section 4.5).

7.4.3.4 Project Management Plan Updates

Elements of the project management plan that may be updated include, but are not limited to:

- **Cost baseline.** Changes to the cost baseline are incorporated in response to approved changes in scope, activity resources, or cost estimates. In some cases, cost variances can be so severe that a revised cost baseline is needed to provide a realistic basis for performance measurement.
- **Cost management plan.** Changes to the cost management plan, such as changes to control thresholds or specified levels of accuracy required in managing the project's cost, are incorporated in response to feedback from relevant stakeholders.

7.4.3.5 Project Documents Updates

Project documents that may be updated include, but are not limited to:

- Cost estimates, and
- Basis of estimates.

7.4.3.6 Organizational Process Assets Updates

Organizational process assets that may be updated include, but are not limited to:

- Causes of variances,
- Corrective action chosen and the reasons,
- Financial databases, and
- Other types of lessons learned from project cost control.

8

PROJECT QUALITY MANAGEMENT

Project Quality Management includes the processes and activities of the performing organization that determine quality policies, objectives, and responsibilities so that the project will satisfy the needs for which it was undertaken. Project Quality Management uses policies and procedures to implement, within the project's context, the organization's quality management system and, as appropriate, it supports continuous process improvement activities as undertaken on behalf of the performing organization. Project Quality Management works to ensure that the project requirements, including product requirements, are met and validated.

Figure 8-1 provides an overview of the Project Quality Management processes, which include:

- 8.1 Plan Quality Management**—The process of identifying quality requirements and/or standards for the project and its deliverables and documenting how the project will demonstrate compliance with quality requirements.
- 8.2 Perform Quality Assurance**—The process of auditing the quality requirements and the results from quality control measurements to ensure that appropriate quality standards and operational definitions are used.
- 8.3 Control Quality**—The process of monitoring and recording results of executing the quality activities to assess performance and recommend necessary changes.

These processes interact with each other and with processes in other Knowledge Areas as described in detail in Section 3 and Annex A1.

Project Quality Management addresses the management of the project and the deliverables of the project. It applies to all projects, regardless of the nature of their deliverables. Quality measures and techniques are specific to the type of deliverables being produced by the project. For example, the project quality management of software deliverables may use different approaches and measures from those used when building a nuclear power plant. In either case, failure to meet the quality requirements can have serious, negative consequences for any or all of the project's stakeholders. For example:

- Meeting customer requirements by overworking the project team may result in decreased profits and increased project risks, employee attrition, errors, or rework.
- Meeting project schedule objectives by rushing planned quality inspections may result in undetected errors, decreased profits, and increased post-implementation risks.

Quality and *grade* are not the same concepts. Quality as a delivered performance or result is “the degree to which a set of inherent characteristics fulfill requirements” (ISO 9000) [10]. Grade as a design intent is a category assigned to deliverables having the same functional use but different technical characteristics. The project manager and the project management team are responsible for managing the tradeoffs associated with delivering the required levels of both quality and grade. While a quality level that fails to meet quality requirements is always a problem, a low grade of quality may not be a problem. For example:

- It may not be a problem if a suitable low-grade software product (one with a limited number of features) is of high quality (no obvious defects, readable manual). In this example, the product would be appropriate for its general purpose of use.
- It may be a problem if a high-grade software product (one with numerous features) is of low quality (many defects, poorly organized user documentation). In essence, its high-grade feature set would prove ineffective and/or inefficient due to its low quality.

The project management team should determine the appropriate levels of accuracy and precision for use in the quality management plan. *Precision* is a measure of exactness. For example, the magnitude for each increment on the measurement’s number line is the interval that determines the measurement’s precision—the greater the number of increments, the greater the precision. *Accuracy* is an assessment of correctness. For example, if the measured value of an item is very close to the true value of the characteristic being measured, the measurement is more accurate. An illustration of this concept is the comparison of archery targets. Arrows clustered tightly in one area of the target, even if they are not clustered in the bull’s-eye, are considered to have high precision. Targets where the arrows are more spread out but equidistant from the bull’s-eye are considered to have the same degree of accuracy. Targets where the arrows are both tightly grouped and within the bull’s-eye are considered to be both accurate and precise. Precise measurements are not necessarily accurate measurements, and accurate measurements are not necessarily precise measurements.

The basic approach to project quality management as described in this section is intended to be compatible with International Organization for Standardization (ISO) quality standards. Every project should have a quality management plan. Project teams should follow the quality management plan and should have data to demonstrate compliance with the plan.

In the context of achieving ISO compatibility, modern quality management approaches seek to minimize variation and to deliver results that meet defined requirements. These approaches recognize the importance of:

- **Customer satisfaction.** Understanding, evaluating, defining, and managing requirements so that customer expectations are met. This requires a combination of conformance to requirements (to ensure the project produces what it was created to produce) and fitness for use (the product or service needs to satisfy the real needs).
- **Prevention over inspection.** Quality should be planned, designed, and built into—not inspected into the project’s management or the project’s deliverables. The cost of preventing mistakes is generally much less than the cost of correcting mistakes when they are found by inspection or during usage.
- **Continuous improvement.** The PDCA (plan-do-check-act) cycle is the basis for quality improvement as defined by Shewhart and modified by Deming. In addition, quality improvement initiatives such as Total Quality Management (TQM), Six Sigma, and Lean Six Sigma could improve the quality of the project’s management as well as the quality of the project’s product. Commonly used process improvement models include Malcolm Baldrige, *Organizational Project Management Maturity Model (OPM3®)*, and Capability Maturity Model Integrated (CMMI®).
- **Management Responsibility.** Success requires the participation of all members of the project team. Nevertheless, management retains, within its responsibility for quality, a related responsibility to provide suitable resources at adequate capacities.
- **Cost of quality (COQ).** Cost of quality refers to the total cost of the conformance work and the nonconformance work that should be done as a compensatory effort because, on the first attempt to perform that work, the potential exists that some portion of the required work effort may be done or has been done incorrectly. The costs for quality work may be incurred throughout the deliverable’s life cycle. For example, decisions made by the project team can impact the operational costs associated with using a completed deliverable. Post-project quality costs may be incurred because of product returns, warranty claims, and recall campaigns. Therefore, because of the temporary nature of projects and the potential benefits that may be derived from reducing the post-project cost of quality, sponsoring organizations may choose to invest in product quality improvement. These investments generally are made in the areas of conformance work that act to prevent defects or act to mitigate the costs of defects by inspecting out nonconforming units. Refer to Figure 8-2 and Section 8.1.2.2. Moreover, the issues related to post-project COQ should be the concern of program management and portfolio management such that project, program, and portfolio management offices should apply appropriate reviews, templates, and funding allocations for this purpose.

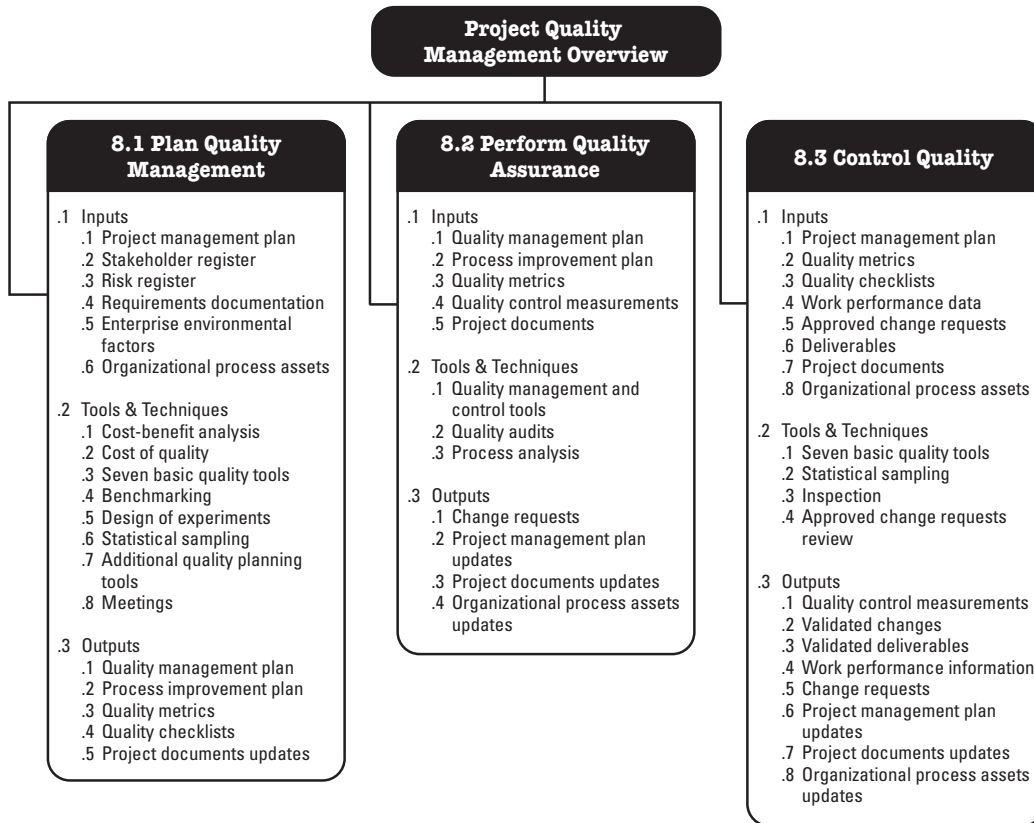

Figure 8-1. Project Quality Management Overview

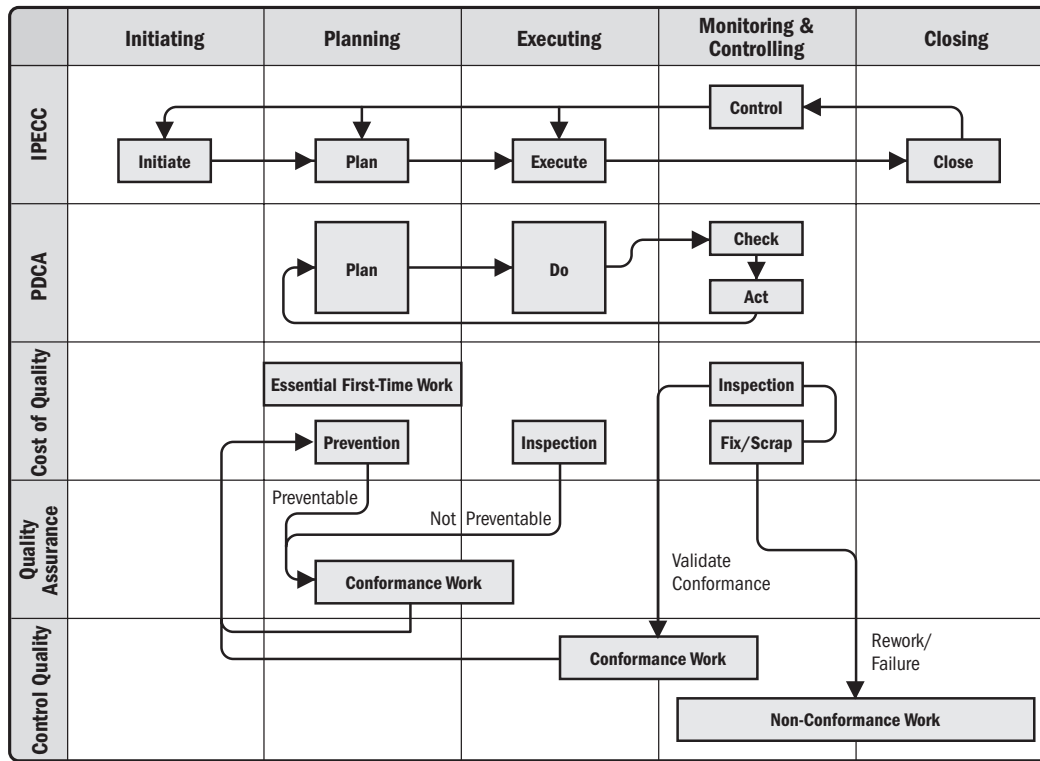

Figure 8-2. Fundamental Relationships of Quality Assurance and Control Quality to the IPECC, PDCA, Cost of Quality Models and Project Management Process Groups

8.1 Plan Quality Management

Plan Quality Management is the process of identifying quality requirements and/or standards for the project and its deliverables, and documenting how the project will demonstrate compliance with relevant quality requirements. The key benefit of this process is that it provides guidance and direction on how quality will be managed and validated throughout the project. The inputs, tools and techniques, and outputs of this process are depicted in Figure 8-3. Figure 8-4 depicts the data flow diagram of the process.

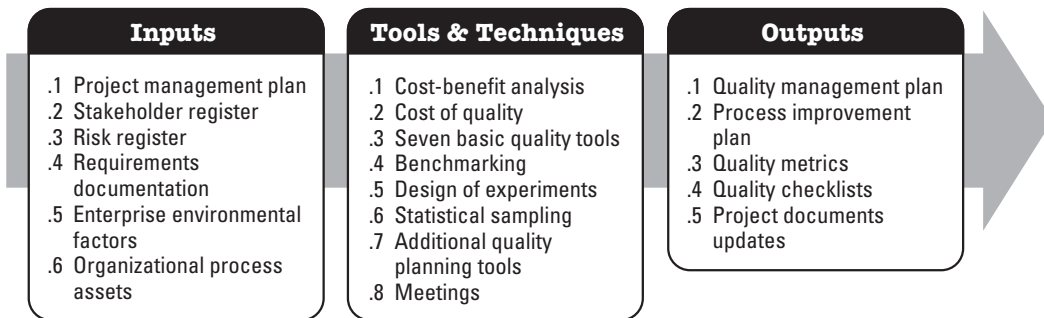

Figure 8-3. Plan Quality Management Inputs, Tools & Techniques, and Outputs

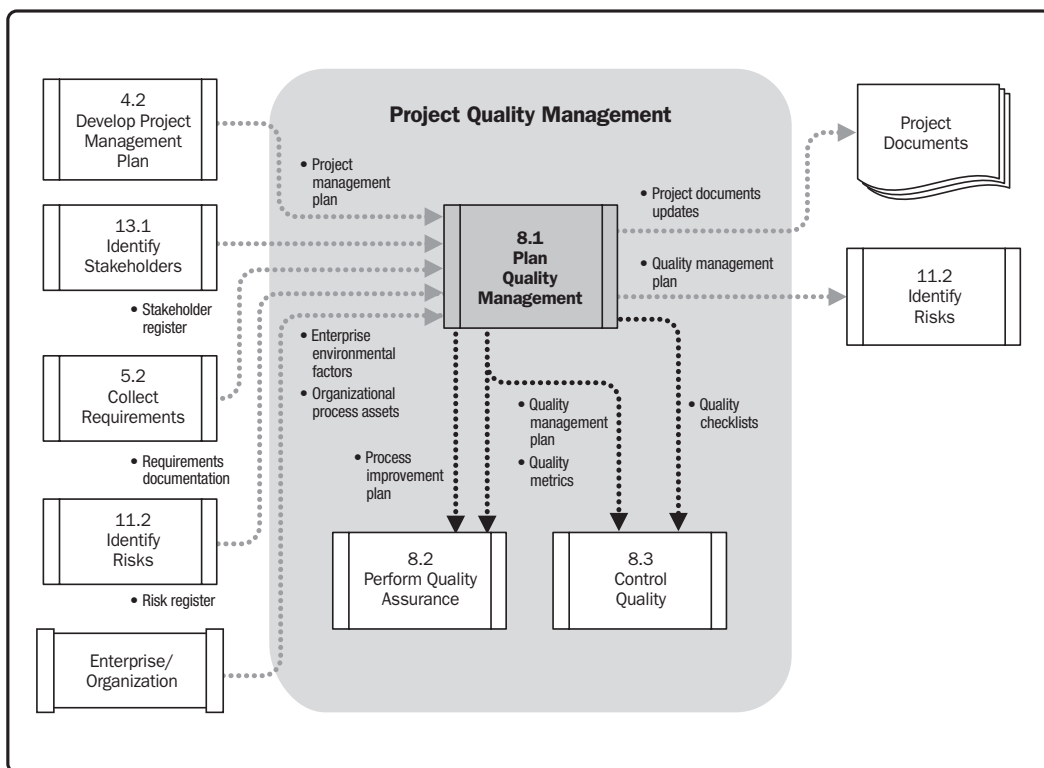

Figure 8-4. Plan Quality Management Data Flow Diagram

Quality planning should be performed in parallel with the other planning processes. For example, proposed changes in the deliverables to meet identified quality standards may require cost or schedule adjustments and a detailed risk analysis of the impact to plans.

The quality planning techniques discussed here are those used most frequently on projects. There are many others that may be useful on certain projects or in some application areas.

8.1.1 Plan Quality Management: Inputs

8.1.1.1 Project Management Plan

Described in Section 4.2.3.1. The project management plan is used to develop the quality management plan. The information used for the development of the quality management plan includes, but is not limited to:

- **Scope baseline.** The scope baseline (Section 5.4.3.1) includes:
 - *Project scope statement.* The project scope statement contains the project description, major project deliverables, and acceptance criteria. The product scope often contains details of technical issues and other concerns that can affect quality planning and that should have been identified as a result of the planning processes in Project Scope Management. The definition of acceptance criteria may significantly increase or decrease quality costs and therefore, project costs. Satisfying all acceptance criteria that the needs of the sponsor and/or customer have been met.
 - *Work breakdown structure (WBS).* The WBS identifies the deliverables and the work packages used to measure project performance.
 - *WBS dictionary.* The WBS dictionary provides detailed information for WBS elements.
- **Schedule baseline.** The schedule baseline documents the accepted schedule performance measures, including start and finish dates (Section 6.6.3.1).
- **Cost baseline.** The cost baseline documents the accepted time interval being used to measure cost performance (Section 7.3.3.1).
- **Other management plans.** These plans contribute to the overall project quality and may highlight actionable areas of concern with regard to the project's quality.

8.1.1.2 Stakeholder Register

Described in Section 13.1.3.1. The stakeholder register aids in identifying those stakeholders possessing a particular interest in, or having an impact on, quality.

8.1.1.3 Risk Register

Described in Section 11.2.3.1. The risk register contains information on threats and opportunities that may impact quality requirements.

8.1.1.4 Requirements Documentation

Described in Section 5.2.3.1. Requirements documentation captures the requirements that the project shall meet pertaining to stakeholder expectations. The components of the requirements documentation include, but are not limited to, project (including product) and quality requirements. The requirements are used by the project team to help plan how quality control will be implemented on the project.

8.1.1.5 Enterprise Environmental Factors

Described in Section 2.1.5. The enterprise environmental factors that influence the Plan Quality Management process include, but are not limited to:

- Governmental agency regulations;
- Rules, standards, and guidelines specific to the application area;
- Working or operating conditions of the project or its deliverables that may affect project quality; and
- Cultural perceptions that may influence expectations about quality.

8.1.1.6 Organizational Process Assets

Described in Section 2.1.4. The organizational process assets that influence the Plan Quality Management process include, but are not limited to:

- Organizational quality policies, procedures, and guidelines. The performing organization's quality policy, as endorsed by senior management, sets the organization's intended direction on implementing its quality management approach;
- Historical databases; and
- Lessons learned from previous phases or projects.

8.1.2 Plan Quality Management: Tools and Techniques

8.1.2.1 Cost-Benefit Analysis

The primary benefits of meeting quality requirements include less rework, higher productivity, lower costs, increased stakeholder satisfaction, and increased profitability. A cost-benefit analysis for each quality activity compares the cost of the quality step to the expected benefit.

8.1.2.2 Cost of Quality (COQ)

Cost of quality includes all costs incurred over the life of the product by investment in preventing nonconformance to requirements, appraising the product or service for conformance to requirements, and failing to meet requirements (rework). Failure costs are often categorized into internal (found by the project) and external (found by the customer). Failure costs are also called cost of poor quality. Figure 8-5 provides some examples to consider in each area.

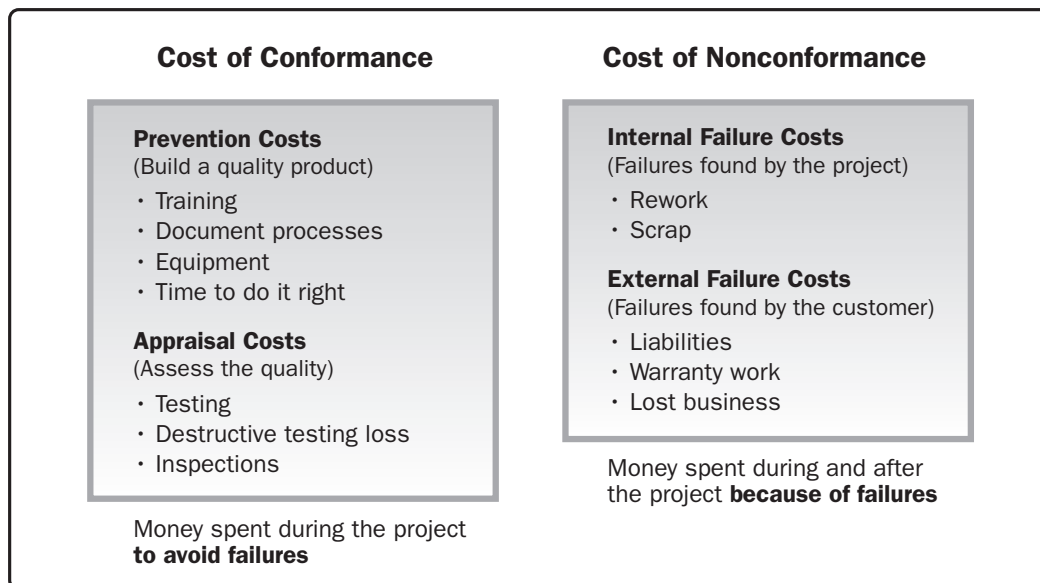

Figure 8-5. Cost of Quality

8.1.2.3 Seven Basic Quality Tools

The seven basic quality tools, also known in the industry as 7QC Tools, are used within the context of the PDCA Cycle to solve quality-related problems. As conceptually illustrated in Figure 8-7, the seven basic quality tools are:

- *Cause-and-effect diagrams*, which are also known as fishbone diagrams or as Ishikawa diagrams. The problem statement placed at the head of the fishbone is used as a starting point to trace the problem's source back to its actionable root cause. The problem statement typically describes the problem as a gap to be closed or as an objective to be achieved. The causes are found by looking at the problem statement and asking "why" until the actionable root cause has been identified or until the reasonable possibilities on each fishbone have been exhausted. Fishbone diagrams often prove useful in linking the undesirable effects seen as special variation to the assignable cause upon which project teams should implement corrective actions to eliminate the special variation detected in a control chart.
- *Flowcharts*, which are also referred to as process maps because they display the sequence of steps and the branching possibilities that exist for a process that transforms one or more inputs into one or more outputs. Flowcharts show the activities, decision points, branching loops, parallel paths, and the overall order of processing by mapping the operational details of procedures that exist within a horizontal value chain of a SIPOC model (Figure 8-6). Flowcharts may prove useful in understanding and estimating the cost of quality in a process. This is obtained by using the workflow branching logic and associated relative frequencies to estimate expected monetary value for the conformance and nonconformance work required to deliver the expected conforming output.

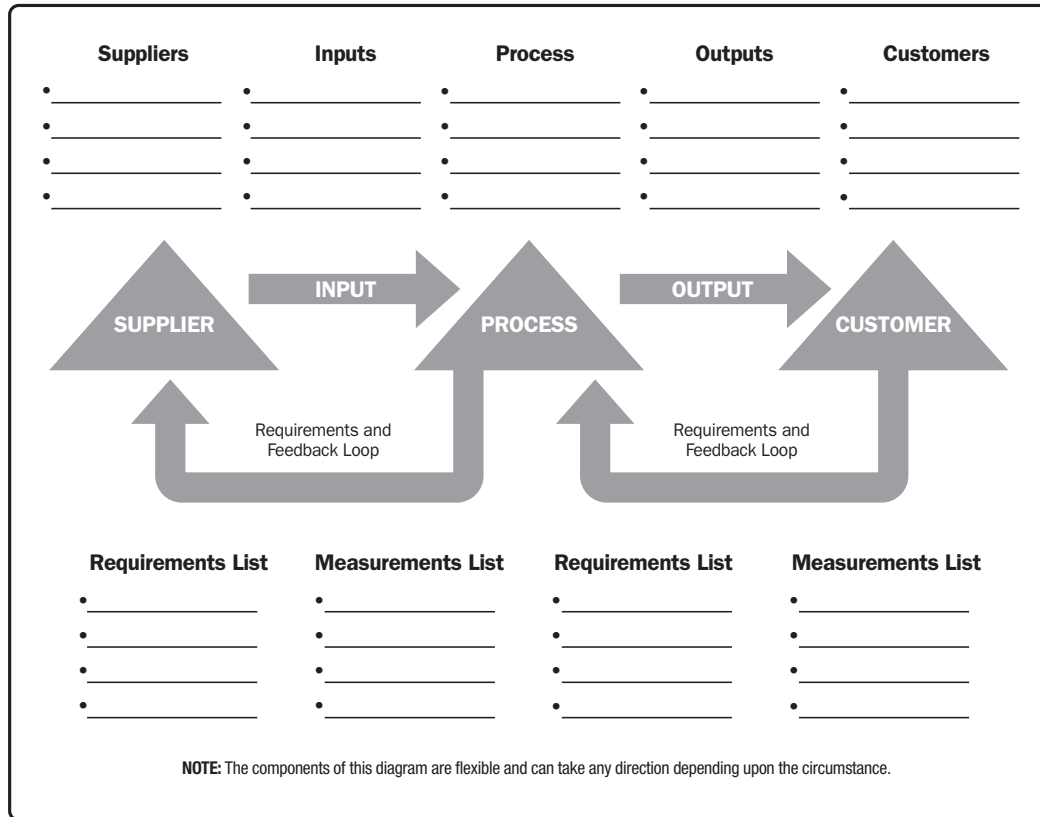

Figure 8-6. The SIPOC Model

- *Checksheets*, which are also known as tally sheets and may be used as a checklist when gathering data. Checksheets are used to organize facts in a manner that will facilitate the effective collection of useful data about a potential quality problem. They are especially useful for gathering attributes data while performing inspections to identify defects. For example, data about the frequencies or consequences of defects collected in checksheets are often displayed using Pareto diagrams.
- *Pareto diagrams*, exist as a special form of vertical bar chart and are used to identify the vital few sources that are responsible for causing most of a problem's effects. The categories shown on the horizontal axis exist as a valid probability distribution that accounts for 100% of the possible observations. The relative frequencies of each specified cause listed on the horizontal axis decrease in magnitude until the default source named "other" accounts for any nonspecified causes. Typically, the Pareto diagram will be organized into categories that measure either frequencies or consequences.

- *Histograms*, are a special form of bar chart and are used to describe the central tendency, dispersion, and shape of a statistical distribution. Unlike the control chart, the histogram does not consider the influence of time on the variation that exists within a distribution.
- *Control charts*, are used to determine whether or not a process is stable or has predictable performance. Upper and lower specification limits are based on requirements of the agreement. They reflect the maximum and minimum values allowed. There may be penalties associated with exceeding the specification limits. Upper and lower control limits are different from specification limits. The control limits are determined using standard statistical calculations and principles to ultimately establish the natural capability for a stable process. The project manager and appropriate stakeholders may use the statistically calculated control limits to identify the points at which corrective action will be taken to prevent unnatural performance. The corrective action typically seeks to maintain the natural stability of a stable and capable process. For repetitive processes, the control limits are generally set at $\pm 3\sigma$ around a process mean that has been set at 0σ . A process is considered out of control when: (1) a data point exceeds a control limit; (2) seven consecutive plot points are above the mean; or (3) seven consecutive plot points are below the mean. Control charts can be used to monitor various types of output variables. Although used most frequently to track repetitive activities required for producing manufactured lots, control charts may also be used to monitor cost and schedule variances, volume, and frequency of scope changes, or other management results to help determine if the project management processes are in control.
- *Scatter diagrams*, plot ordered pairs (X, Y) and are sometimes called correlation charts because they seek to explain a change in the dependent variable, Y, in relationship to a change observed in the corresponding independent variable, X. The direction of correlation may be proportional (positive correlation), inverse (negative correlation), or a pattern of correlation may not exist (zero correlation). If correlation can be established, a regression line can be calculated and used to estimate how a change to the independent variable will influence the value of the dependent variable.

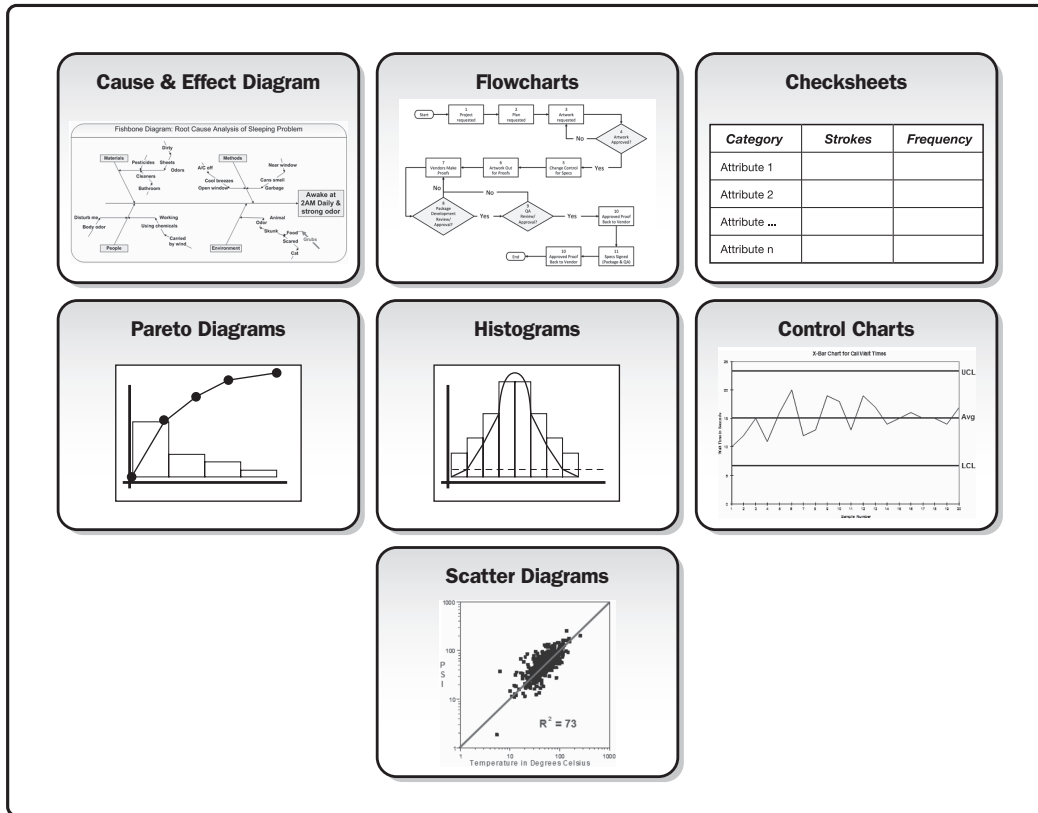

Figure 8-7. Storyboard Illustrating a Conceptual Example of Each of the Seven Basic Quality Tools

8.1.2.4 Benchmarking

Benchmarking involves comparing actual or planned project practices to those of comparable projects to identify best practices, generate ideas for improvement, and provide a basis for measuring performance.

Benchmarked projects may exist within the performing organization or outside of it, or can be within the same application area. Benchmarking allows for analogies from projects in a different application area to be made.

8.1.2.5 Design of Experiments

Design of experiments (DOE) is a statistical method for identifying which factors may influence specific variables of a product or process under development or in production. DOE may be used during the Plan Quality Management process to determine the number and type of tests and their impact on cost of quality.

DOE also plays a role in optimizing products or processes. DOE is used to reduce the sensitivity of product performance to sources of variations caused by environmental or manufacturing differences. One important aspect of this technique is that it provides a statistical framework for systematically changing all of the important factors, rather than changing the factors one at a time. Analysis of the experimental data should provide the optimal conditions for the product or process, highlight the factors that influence the results, and reveal the presence of interactions and synergy among the factors. For example, automotive designers use this technique to determine which combination of suspension and tires will produce the most desirable ride characteristics at a reasonable cost.

8.1.2.6 Statistical Sampling

Statistical sampling involves choosing part of a population of interest for inspection (for example, selecting ten engineering drawings at random from a list of seventy-five). Sample frequency and sizes should be determined during the Plan Quality Management process so the cost of quality will include the number of tests, expected scrap, etc.

There is a substantial body of knowledge on statistical sampling. In some application areas, it may be necessary for the project management team to be familiar with a variety of sampling techniques to assure the sample selected represents the population of interest.

8.1.2.7 Additional Quality Planning Tools

Other quality planning tools are used to define the quality requirements and to plan effective quality management activities. These include, but are not limited to:

- **Brainstorming.** This technique is used to generate ideas (defined in Section 11.2.2.2).
- **Force field analysis.** These are diagrams of the forces for and against change.
- **Nominal group technique.** This technique is used to allow ideas to be brainstormed in small groups and then reviewed by a larger group.
- **Quality management and control tools.** These tools are used to link and sequence the activities identified (defined in Section 8.2.2.1).

8.1.2.8 Meetings

Project teams may hold planning meetings to develop the quality management plan. Attendees at these meetings may include the project manager; the project sponsor; selected project team members; selected stakeholders; anyone with responsibility for Project Quality Management activities namely Plan Quality Management, Perform Quality Assurance, or Control Quality; and others as needed.

8.1.3 Plan Quality Management: Outputs

8.1.3.1 Quality Management Plan

The quality management plan is a component of the project management plan that describes how the organization's quality policies will be implemented. It describes how the project management team plans to meet the quality requirements set for the project.

The quality management plan may be formal or informal, detailed, or broadly framed. The style and detail of the quality management plan are determined by the requirements of the project. The quality management plan should be reviewed early in the project to ensure that decisions are based on accurate information. The benefits of this review can include a sharper focus on the project's value proposition and reductions in costs and in the frequency of schedule overruns that were caused by rework.

8.1.3.2 Process Improvement Plan

The process improvement plan is a subsidiary or component of the project management plan (Section 4.2.3.1). The process improvement plan details the steps for analyzing project management and product development processes to identify activities that enhance their value. Areas to consider include:

- **Process boundaries.** Describe the purpose of the process, the start and end of the process, its inputs and outputs, the process owner, and the stakeholders of the process.
- **Process configuration.** Provides a graphic depiction of processes, with interfaces identified, used to facilitate analysis.
- **Process metrics.** Along with control limits, allows analysis of process efficiency.
- **Targets for improved performance.** Guide the process improvement activities.

8.1.3.3 Quality Metrics

A quality metric specifically describes a project or product attribute and how the control quality process will measure it. A measurement is an actual value. The tolerance defines the allowable variations to the metric. For example, if the quality objective is to stay within the approved budget by $\pm 10\%$, the specific quality metric is used to measure the cost of every deliverable and determine the percent variance from the approved budget for that deliverable. Quality metrics are used in the perform quality assurance and control quality processes. Some examples of quality metrics include on-time performance, cost control, defect frequency, failure rate, availability, reliability, and test coverage.

8.1.3.4 Quality Checklists

A checklist is a structured tool, usually component-specific, used to verify that a set of required steps has been performed. Based on the project's requirements and practices, checklists may be simple or complex. Many organizations have standardized checklists available to ensure consistency in frequently performed tasks. In some application areas, checklists are also available from professional associations or commercial service providers. Quality checklists should incorporate the acceptance criteria included in the scope baseline.

8.1.3.5 Project Documents Updates

Project documents that may be updated include, but are not limited to:

- Stakeholder register (Section 13.1.3.1); and
- Responsibility assignment matrix (Section 9.1.2.1); and
- WBS and WBS Dictionary.

8.2 Perform Quality Assurance

Perform Quality Assurance is the process of auditing the quality requirements and the results from quality control measurements to ensure that appropriate quality standards and operational definitions are used. The key benefit of this process is that it facilitates the improvement of quality processes. The inputs, tools and techniques, and outputs of this process are depicted in Figure 8-8. Figure 8-9 depicts the data flow diagram of the process.



Figure 8-8. Perform Quality Assurance: Inputs, Tools & Techniques, and Outputs

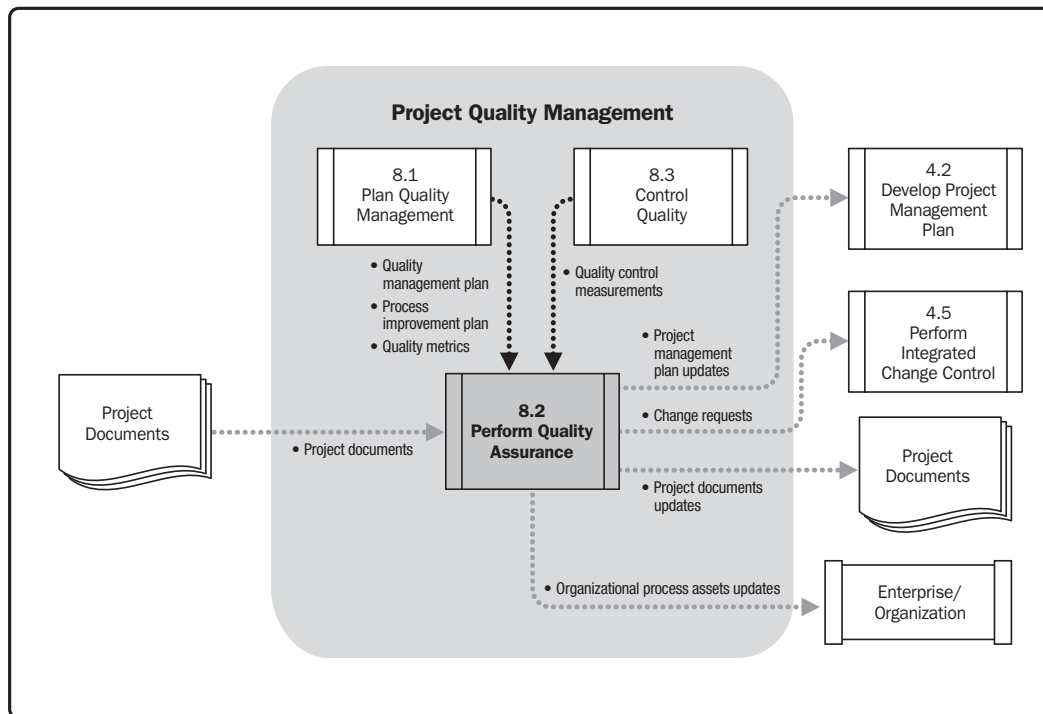

Figure 8-9. Perform Quality Assurance Data Flow Diagram

The quality assurance process implements a set of planned and systematic acts and processes defined within the project’s quality management plan. Quality assurance seeks to build confidence that a future output or an unfinished output, also known as work in progress, will be completed in a manner that meets the specified requirements and expectations. Quality assurance contributes to the state of being certain about quality by preventing defects through the planning processes or by inspecting out defects during the work-in-progress stage of implementation. Perform Quality Assurance is an execution process that uses data created during Plan Quality Management (Section 8.1) and Control Quality (Section 8.3) processes.

In project management, the prevention and inspection aspects of quality assurance should have a demonstrable influence on the project. Quality assurance work will fall under the conformance work category in the cost of quality framework.

A quality assurance department, or similar organization, often oversees quality assurance activities. Quality assurance support, regardless of the unit's title, may be provided to the project team, the management of the performing organization, the customer or sponsor, as well as other stakeholders not actively involved in the work of the project.

Perform Quality Assurance also provides an umbrella for continuous process improvement, which is an iterative means for improving the quality of all processes. Continuous process improvement reduces waste and eliminates activities that do not add value. This allows processes to operate at increased levels of efficiency and effectiveness.

8.2.1 Perform Quality Assurance: Inputs

8.2.1.1 Quality Management Plan

Described in Section 8.1.3.1. The quality management plan describes the quality assurance and continuous process improvement approaches for the project.

8.2.1.2 Process Improvement Plan

Described in Section 8.1.3.2. The project's quality assurance activities should be supportive of and consistent with the performing organization's process improvement plans.

8.2.1.3 Quality Metrics

Described in Section 8.1.3.3. The quality metrics provide the attributes that should be measured and the allowable variations.

8.2.1.4 Quality Control Measurements

Described in Section 8.3.3.1. Quality control measurements are the results of control quality activities. They are used to analyze and evaluate the quality of the processes of the project against the standards of the performing organization or the requirements specified. Quality control measurements can also compare the processes used to create the measurements, and validate actual measurements to determine their level of correctness.

8.2.1.5 Project Documents

Project documents may influence quality assurance work and should be monitored within the context of a system for configuration management.

8.2.2 Perform Quality Assurance: Tools and Techniques

8.2.2.1 Quality Management and Control Tools

The Perform Quality Assurance process uses the tools and techniques of the Plan Quality Management and Control Quality processes. In addition, other tools that are available include (see also Figure 8-10):

- **Affinity diagrams.** The affinity diagram is similar to mind-mapping techniques in that they are used to generate ideas that can be linked to form organized patterns of thought about a problem. In project management, the creation of the WBS may be enhanced by using the affinity diagram to give structure to the decomposition of scope.
- **Process decision program charts (PDPC).** Used to understand a goal in relation to the steps for getting to the goal. The PDPC is useful as a method for contingency planning because it aids teams in anticipating intermediate steps that could derail achievement of the goal.
- **Interrelationship digraphs.** An adaptation of relationship diagrams. The interrelationship digraphs provide a process for creative problem solving in moderately complex scenarios that possess intertwined logical relationships for up to 50 relevant items. The interrelationship digraph may be developed from data generated in other tools such as the affinity diagram, the tree diagram, or the fishbone diagram.
- **Tree diagrams.** Also known as systematic diagrams and may be used to represent decomposition hierarchies such as the WBS, RBS (risk breakdown structure), and OBS (organizational breakdown structure). In project management, tree diagrams are useful in visualizing the parent-to-child relationships in any decomposition hierarchy that uses a systematic set of rules that define a nesting relationship. Tree diagrams can be depicted horizontally (such as a risk breakdown structure) or vertically (such as a team hierarchy or OBS). Because tree diagrams permit the creation of nested branches that terminate into a single decision point, they are useful as decision trees for establishing an expected value for a limited number of dependent relationships that have been diagramed systematically.

- **Prioritization matrices.** Identify the key issues and the suitable alternatives to be prioritized as a set of decisions for implementation. Criteria are prioritized and weighted before being applied to all available alternatives to obtain a mathematical score that ranks the options.
- **Activity network diagrams.** Previously known as arrow diagrams. They include both the AOA (Activity on Arrow) and, most commonly used, AON (Activity on Node) formats of a network diagram. Activity network diagrams are used with project scheduling methodologies such as program evaluation and review technique (PERT), critical path method (CPM), and precedence diagramming method (PDM).
- **Matrix diagrams.** A quality management and control tool used to perform data analysis within the organizational structure created in the matrix. The matrix diagram seeks to show the strength of relationships between factors, causes, and objectives that exist between the rows and columns that form the matrix.

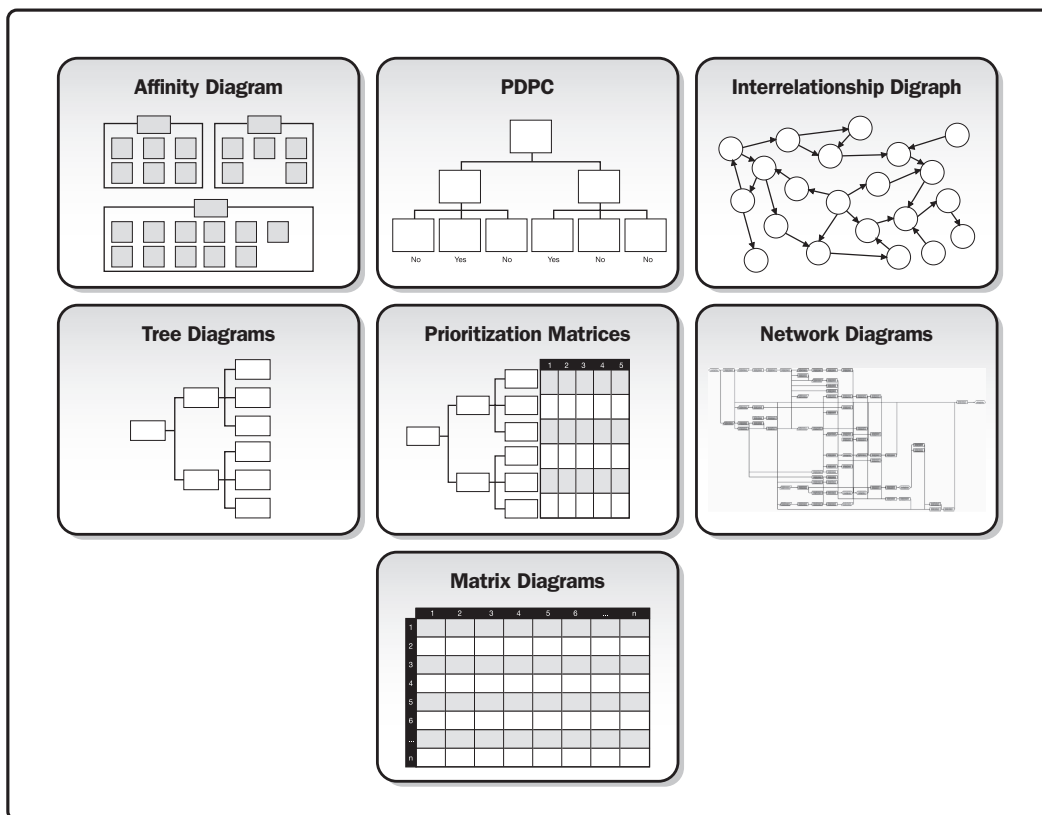

Figure 8-10. Storyboard Illustrating the Seven Quality Management and Control Tools

8.2.2.2 Quality Audits

A quality audit is a structured, independent process to determine if project activities comply with organizational and project policies, processes, and procedures. The objectives of a quality audit may include:

- Identify all good and best practices being implemented;
- Identify all nonconformity, gaps, and shortcomings;
- Share good practices introduced or implemented in similar projects in the organization and/or industry;
- Proactively offer assistance in a positive manner to improve implementation of processes to help the team raise productivity; and
- Highlight contributions of each audit in the lessons learned repository of the organization.

The subsequent effort to correct any deficiencies should result in a reduced cost of quality and an increase in sponsor or customer acceptance of the project's product. Quality audits may be scheduled or random, and may be conducted by internal or external auditors.

Quality audits can confirm the implementation of approved change requests including updates, corrective actions, defect repairs, and preventive actions.

8.2.2.3 Process Analysis

Process analysis follows the steps outlined in the process improvement plan to identify needed improvements. This analysis also examines problems experienced, constraints experienced, and non-value-added activities identified during process operation. Process analysis includes root cause analysis—a specific technique used to identify a problem, discover the underlying causes that lead to it, and develop preventive actions.

8.2.3 Perform Quality Assurance: Outputs

8.2.3.1 Change Requests

Change requests are created and used as input into the Perform Integrated Change Control process (Section 4.5) to allow full consideration of the recommended improvements. Change requests are used to take corrective action, preventive action, or to perform defect repair.

8.2.3.2 Project Management Plan Updates

Elements of the project management plan that may be updated include, but are not limited to:

- Quality management plan (Section 8.1.3.1),
- Scope management plan (Section 5.1.3.1),
- Schedule management plan (Section 6.1.3.1), and
- Cost management plan (7.1.3.1).

8.2.3.3 Project Documents Updates

Project documents that may be updated include, but are not limited to:

- Quality audit reports,
- Training plans, and
- Process documentation.

8.2.3.4 Organizational Process Assets Updates

Elements of the organizational process assets that may be updated include, but are not limited to, the organization's quality standards and the quality management system.

8.3 Control Quality

Control Quality is the process of monitoring and recording results of executing the quality activities to assess performance and recommend necessary changes. The key benefits of this process include: (1) identifying the causes of poor process or product quality and recommending and/or taking action to eliminate them; and (2) validating that project deliverables and work meet the requirements specified by key stakeholders necessary for final acceptance. The inputs, tools and techniques, and outputs of this process are depicted in Figure 8-11. Figure 8-12 depicts the data flow diagram of the process.

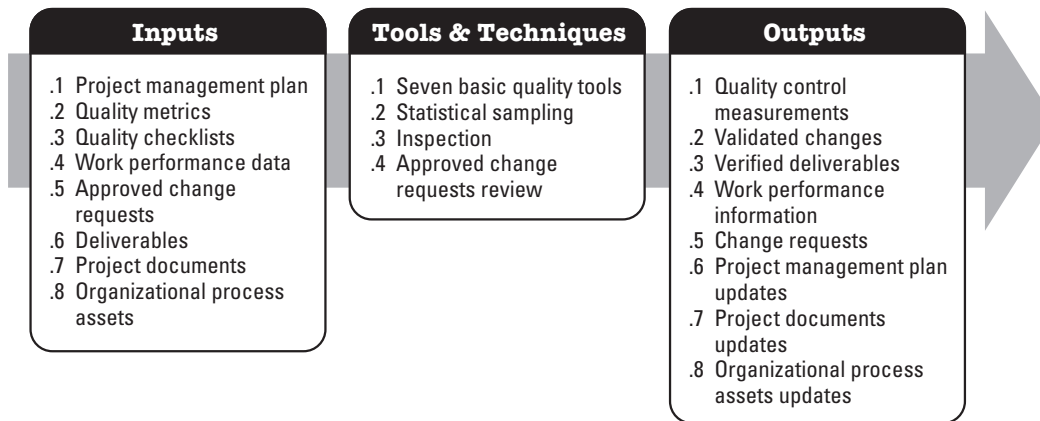

Figure 8-11. Control Quality: Inputs, Tools & Techniques, and Outputs

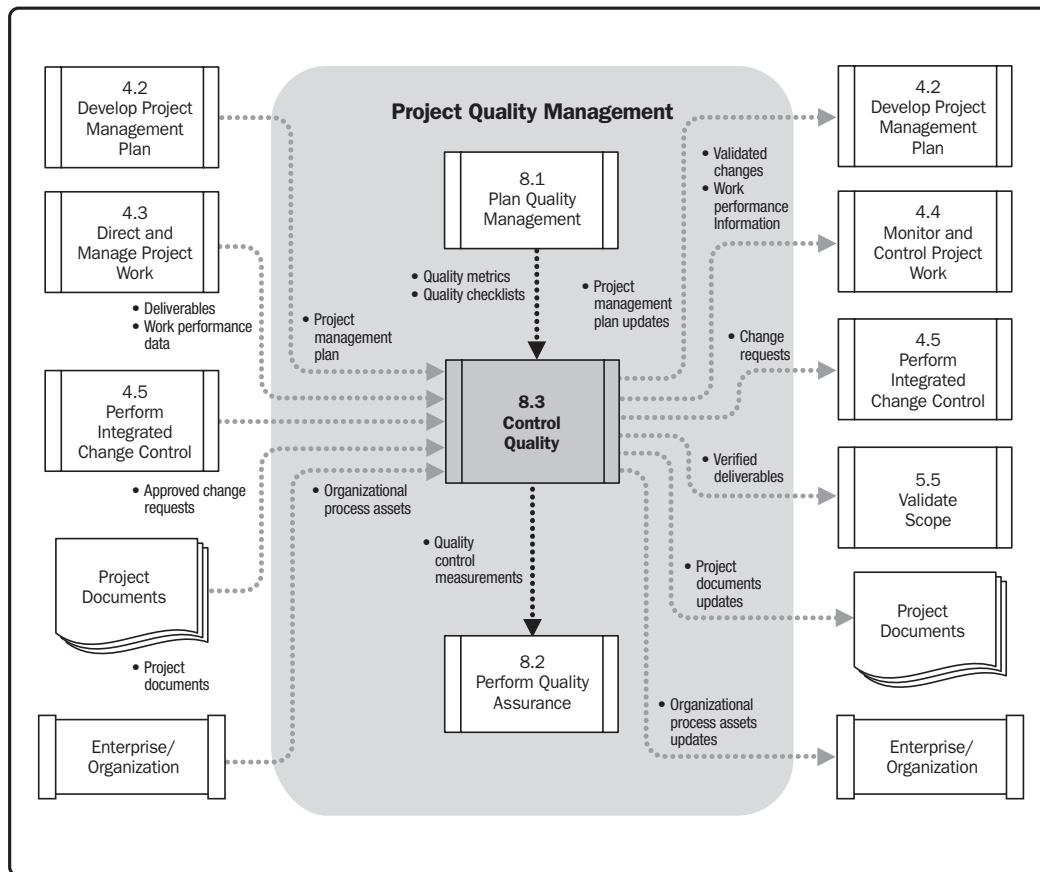

Figure 8-12. Control Quality Data Flow Diagram

The Control Quality process uses a set of operational techniques and tasks to verify that the delivered output will meet the requirements. Quality assurance should be used during the project's planning and executing phases to provide confidence that the stakeholder's requirements will be met and quality control should be used during the project executing and closing phases to formally demonstrate, with reliable data, that the sponsor and/or customer's acceptance criteria have been met.

The project management team may have a working knowledge of statistical control processes to evaluate data contained in the control quality outputs. Among other subjects, the team may find it useful to know the differences between the following pairs of terms:

- *Prevention* (keeping errors out of the process) and *inspection* (keeping errors out of the hands of the customer).
- *Attribute sampling* (the result either conforms or does not conform) and *variables sampling* (the result is rated on a continuous scale that measures the degree of conformity).
- *Tolerances* (specified range of acceptable results) and *control limits* (that identify the boundaries of common variation in a statistically stable process or process performance).

8.3.1 Control Quality: Inputs

8.3.1.1 Project Management Plan

Described in Section 8.1.3.1. The project management plan contains the quality management plan, which is used to control quality. The quality management plan describes how quality control will be performed within the project.

8.3.1.2 Quality Metrics

Described in Section 4.2.3.1. A quality metric describes a project or product attribute and how it will be measured. Some examples of quality metrics include: function points, mean time between failure (MTBF), and mean time to repair (MTTR).

8.3.1.3 Quality Checklists

Described in Section 8.1.3.4. Quality checklists are structured lists that help to verify that the work of the project and its deliverables fulfill a set of requirements.

8.3.1.4 Work Performance Data

Described in Section 4.3.3.2. Work performance data can include:

- Planned vs. actual technical performance,
- Planned vs. actual schedule performance, and
- Planned vs. actual cost performance.

8.3.1.5 Approved Change Requests

As part of the Perform Integrated Change Control process, a change log update indicates that some changes are approved and some are not. Approved change requests may include modifications such as defect repairs, revised work methods, and revised schedule. The timely implementation of approved changes needs to be verified.

8.3.1.6 Deliverables

Described in Section 4.3.3.1. A deliverable is any unique and verifiable product, result, or capability that results in a validated deliverable required by the project.

8.3.1.7 Project Documents

Project documents may include, but are not limited to:

- Agreements,
- Quality audit reports and change logs supported with corrective action plans,
- Training plans and assessments of effectiveness, and
- Process documentation such as those obtained using either the seven basic quality tools or the quality management and control tools shown in Figures 8-7 and 8-10.

8.3.1.8 Organizational Process Assets

Described in Section 2.1.4. The organizational process assets that influence the Control Quality process include, but are not limited to:

- The organization's quality standards and policies,
- Standard work guidelines, and
- Issue and defect reporting procedures and communication policies.

8.3.2 Control Quality: Tools and Techniques

8.3.2.1 Seven Basic Quality Tools

Described in Section 8.1.2.3. The seven basic quality tools are illustrated conceptually in Figure 8-7.

8.3.2.2 Statistical Sampling

Described in Section 8.1.2.6. Samples are selected and tested as defined in the quality management plan.

8.3.2.3 Inspection

An inspection is the examination of a work product to determine if it conforms to documented standards. The results of an inspection generally include measurements and may be conducted at any level. For example, the results of a single activity can be inspected, or the final product of the project can be inspected. Inspections may be called reviews, peer reviews, audits, or walkthroughs. In some application areas, these terms have narrow and specific meanings. Inspections also are used to validate defect repairs.

8.3.2.4 Approved Change Requests Review

All approved change requests should be reviewed to verify that they were implemented as approved.

8.3.3 Control Quality: Outputs

8.3.3.1 Quality Control Measurements

Quality control measurements are the documented results of control quality activities. They should be captured in the format that was specified through the Plan Quality Management process (Section 8.1).

8.3.3.2 Validated Changes

Any changed or repaired items are inspected and will be either accepted or rejected before notification of the decision is provided. Rejected items may require rework.

8.3.3.3 Verified Deliverables

A goal of the Control Quality process is to determine the correctness of deliverables. The results of performing the Control Quality process are verified deliverables. Verified deliverables are an input to Validate Scope (5.5.1.4) for formalized acceptance.

8.3.3.4 Work Performance Information

Work performance information is the performance data collected from various controlling processes, analyzed in context and integrated based on relationships across areas. Examples include information about the project requirements fulfillment such as causes for rejections, rework required, or the need for process adjustments.

8.3.3.5 Change Requests

If the recommended corrective or preventive actions or a defect repair requires a change to the project management plan, a change request (Section 4.4.3.1) should be initiated in accordance with the defined Perform Integrated Change Control (4.5) process.

8.3.3.6 Project Management Plan Updates

Elements of the project management plan that may be updated include, but are not limited to:

- Quality management plan (Section 8.1.3.1), and
- Process improvement plan (Section 8.1.3.2).

8.3.3.7 Project Documents Updates

Project documents that may be updated include, but are not limited to,

- Quality standards;
- Agreements;
- Quality audit reports and change logs supported with corrective action plans;
- Training plans and assessments of effectiveness; and
- Process documentation, such as information obtained using the seven basic quality tools or the quality management and control tools.

8.3.3.8 Organizational Process Assets Updates

Elements of the organizational process assets that may be updated include, but are not limited to:

- **Completed checklists.** When checklists are used, the completed checklists become part of the project documents and organizational process assets (Section 4.1.1.5).
- **Lessons learned documentation.** The causes of variances, the reasoning behind the corrective action chosen, and other types of lessons learned from control quality are documented so they become part of the historical database for both the project and the performing organization.

9

PROJECT HUMAN RESOURCE MANAGEMENT

Project Human Resource Management includes the processes that organize, manage, and lead the project team. The project team is comprised of the people with assigned roles and responsibilities for completing the project. Project team members may have varied skill sets, may be assigned full or part-time, and may be added or removed from the team as the project progresses. Project team members may also be referred to as the project's staff. Although specific roles and responsibilities for the project team members are assigned, the involvement of all team members in project planning and decision making is beneficial. Participation of team members during planning adds their expertise to the process and strengthens their commitment to the project.

Figure 9-1 provides an overview of the Project Human Resource Management processes, which are as follows:

- 9.1 Plan Human Resource Management**—The process of identifying and documenting project roles, responsibilities, required skills, reporting relationships, and creating a staffing management plan.
- 9.2 Acquire Project Team**—The process of confirming human resource availability and obtaining the team necessary to complete project activities.
- 9.3 Develop Project Team**—The process of improving competencies, team member interaction, and overall team environment to enhance project performance.
- 9.4 Manage Project Team**—The process of tracking team member performance, providing feedback, resolving issues, and managing changes to optimize project performance.

These processes interact with each other and with processes in other Knowledge Areas as described in detail in Section 3 and Annex A1.

As a result of these interactions additional planning may be required throughout the project. For example:

- After initial team members create a work breakdown structure, additional team members may need to be added to the team.
- As additional team members are added to the team, their experience levels, or lack thereof, could decrease or increase project risk, creating the need for additional risk planning.
- When activity durations are estimated, budgeted, scoped, or planned prior to identifying all project team members and their competency levels, the activity durations may change.

The project management team is a subset of the project team and is responsible for the project management and leadership activities such as initiating, planning, executing, monitoring, controlling, and closing the various project phases. This group can also be referred to as the core, executive, or leadership team. For smaller projects, the project management responsibilities may be shared by the entire team or administered solely by the project manager. The project sponsor works with the project management team, typically assisting with matters such as project funding, clarifying scope, monitoring progress, and influencing stakeholders in both the requesting and performing organization for the project benefit.

Managing and leading the project team includes, but is not limited to:

- **Influencing the project team.** The project manager needs to be aware of and influence, when possible, human resource factors that may impact the project. These factors includes team environment, geographical locations of team members, communications among stakeholders, internal and external politics, cultural issues, organizational uniqueness, and others factors that may alter project performance.
- **Professional and ethical behavior.** The project management team should be aware of, subscribe to, and ensure that all team members follow professional and ethical behavior.

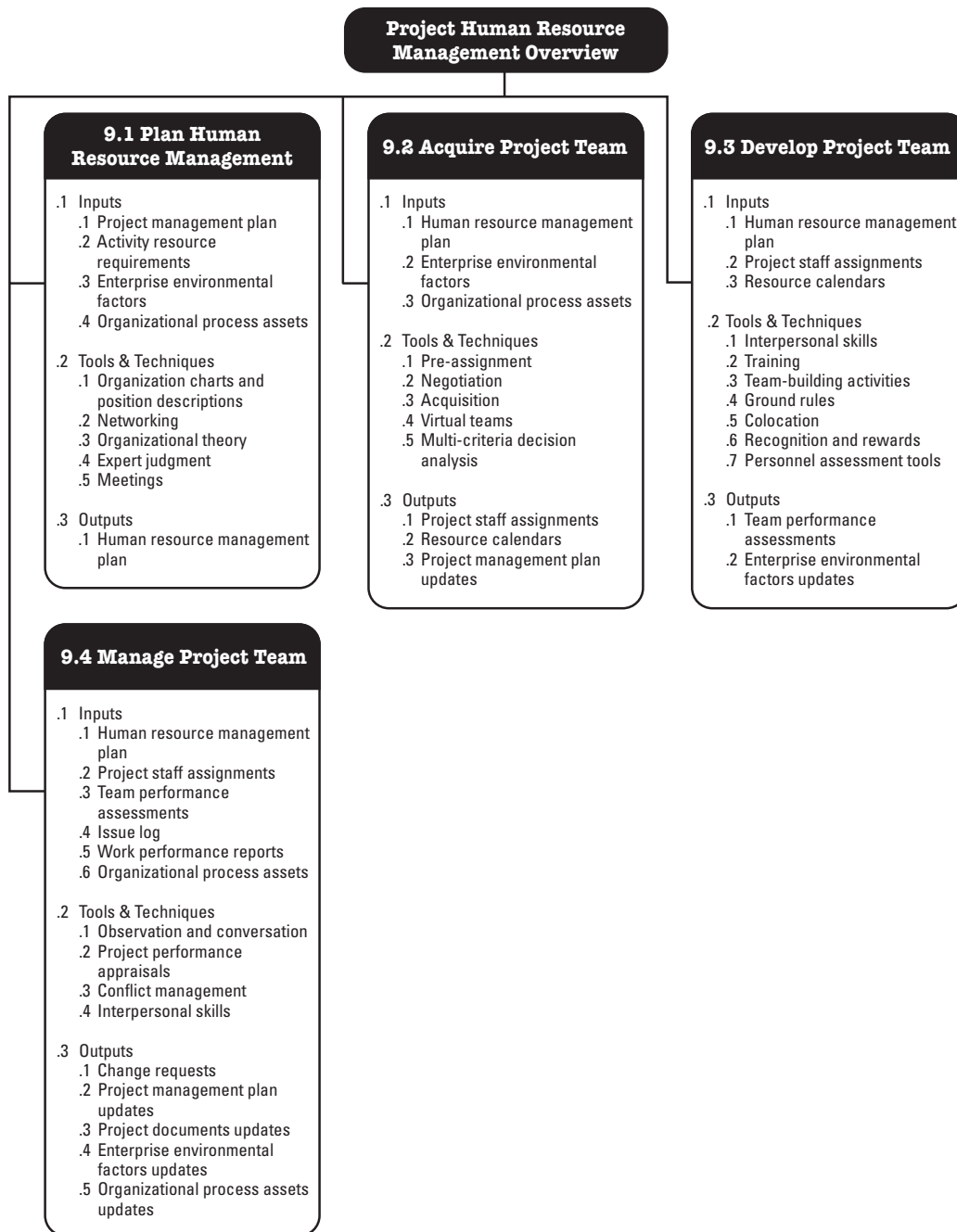

Figure 9-1. Project Human Resource Management Overview

9.1 Plan Human Resource Management

Plan Human Resource Management is the process of identifying and documenting project roles, responsibilities, required skills, reporting relationships, and creating a staffing management plan. The key benefit of this process is that it establishes project roles and responsibilities, project organization charts, and the staffing management plan including the timetable for staff acquisition and release. The inputs, tools and techniques, and outputs of this process are depicted in Figure 9-2. Figure 9-3 depicts the data flow diagram of the process.

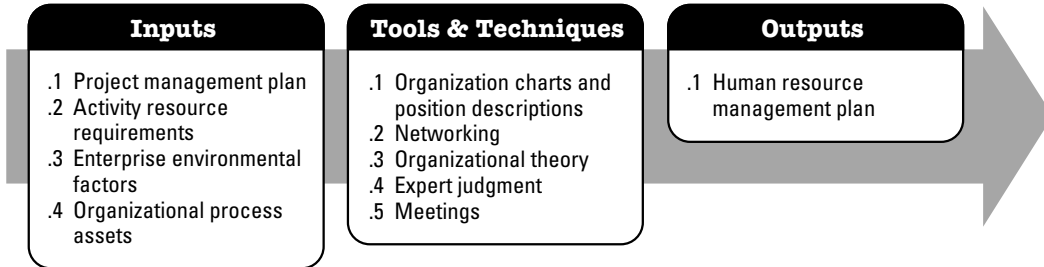

Figure 9-2. Plan Human Resource Management: Inputs, Tools & Techniques, and Outputs

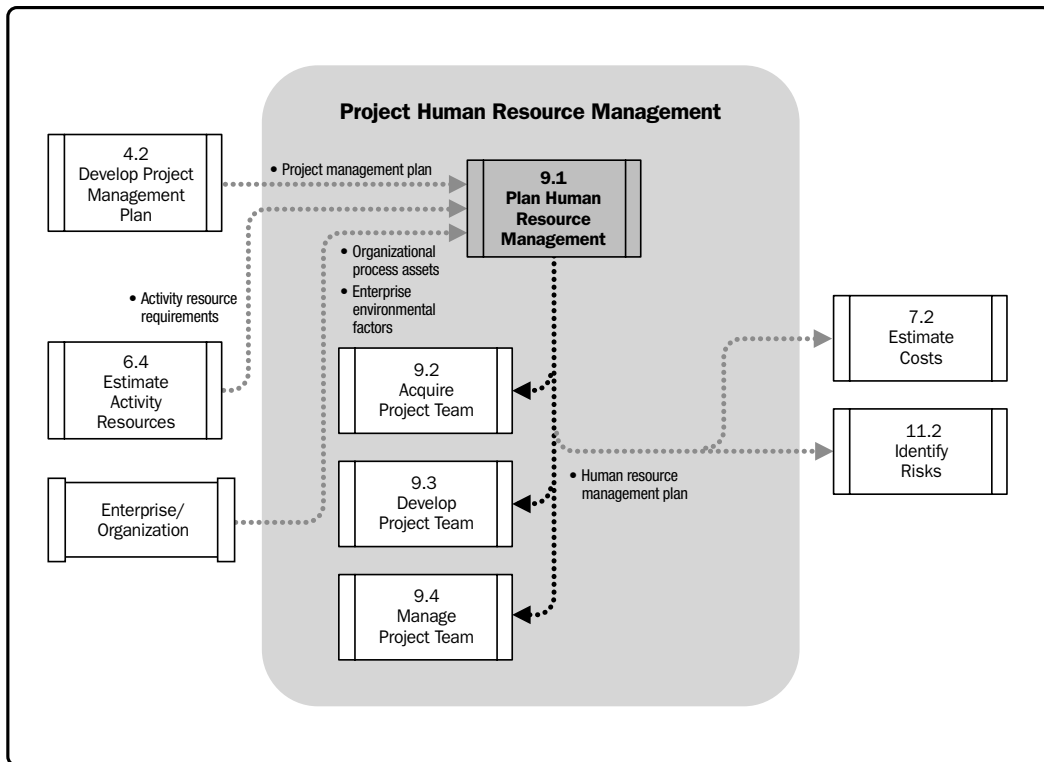

Figure 9-3. Plan Human Resource Management Data Flow Diagram

Human resource planning is used to determine and identify human resources with the necessary skills required for project success. The human resource management plan describes how the roles and responsibilities, reporting relationships, and staffing management will be addressed and structured within a project. It also contains the staffing management plan including timetables for staff acquisition and release, identification of training needs, team-building strategies, plans for recognition and rewards programs, compliance considerations, safety issues, and the impact of the staffing management plan on the organization.

Effective human resource planning should consider and plan for the availability of or competition for scarce resources. Project roles can be designated for teams or team members. Those teams or team members can be from inside or outside the organization performing the project. Other projects may be competing for human resources with the same competencies or skill sets. Given these factors, project costs, schedules, risks, quality, and other project areas may be significantly affected.

9.1.1 Plan Human Resource Management: Inputs

9.1.1.1 Project Management Plan

Described in Section 4.2.3.1. The project management plan is used to develop the human resource management plan as described in Section 9.1.3.1. The information used for the development of the human resource management plan includes, but is not limited to:

- The project life cycle and the processes that will be applied to each phase,
- How work will be executed to accomplish the project objectives,
- A change management plan that documents how changes will be monitored and controlled,
- A configuration management plan that documents how configuration management will be performed,
- How integrity of the project baselines will be maintained, and
- Needs and methods of communication among stakeholders.

9.1.1.2 Activity Resource Requirements

Described in Section 6.4.3.1. Human resource planning uses activity resource requirements to determine the human resource needs for the project. The preliminary requirements regarding the required project team members and their competencies are progressively elaborated as part of the Plan Human Resource Management process.

9.1.1.3 Enterprise Environmental Factors

Described in Section 2.1.5. The enterprise environmental factors that can influence the Plan Human Resource Management process include, but are not limited to:

- Organizational culture and structure,
- Existing human resources,
- Geographical dispersion of team members,
- Personnel administration policies, and
- Marketplace conditions.

9.1.1.4 Organizational Process Assets

Described in Section 2.1.4. The organizational process assets that can influence the Plan Human Resource Management process include, but are not limited to:

- Organizational standard processes, policies, and role descriptions;
- Templates for organizational charts and position descriptions;
- Lessons learned on organizational structures that have worked in previous projects; and
- Escalation procedures for handling issues within the team and within the performing organization.

9.1.2 Plan Human Resource Management: Tools and Techniques

9.1.2.1 Organization Charts and Position Descriptions

Various formats exist to document team member roles and responsibilities. Most of the formats fall into one of three types (Figure 9-4): hierarchical, matrix, and text-oriented. Additionally, some project assignments are listed in subsidiary plans, such as the risk, quality, or communications management plans. Regardless of the method utilized, the objective is to ensure that each work package has an unambiguous owner and that all team members have a clear understanding of their roles and responsibilities. For example, a hierarchical format may be used to represent high-level roles, while a text-based format may be better suited to document the detailed responsibilities.

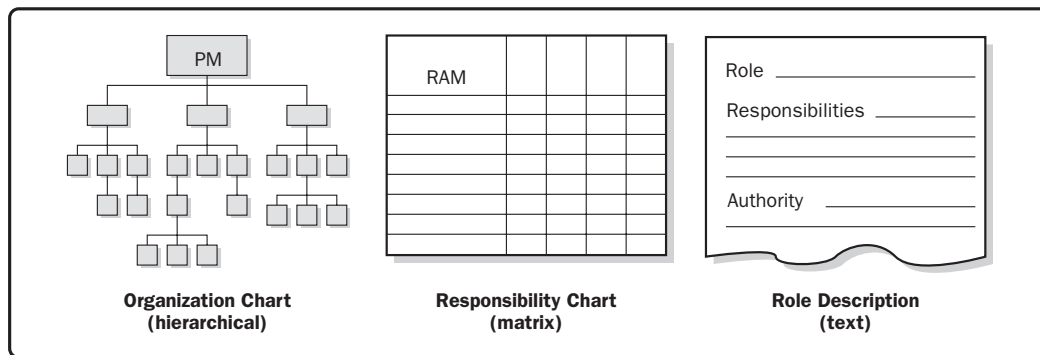

Figure 9-4. Roles and Responsibility Definition Formats

- Hierarchical-type charts.** The traditional organization chart structure can be used to show positions and relationships in a graphical, top-down format. Work breakdown structures (WBS) designed to show how project deliverables are broken down into work packages provide a way of showing high-level areas of responsibility. While the WBS shows a breakdown of project deliverables, the organizational breakdown structure (OBS) is arranged according to an organization's existing departments, units, or teams with the project activities or work packages listed under each department. An operational department such as information technology or purchasing can see all of its project responsibilities by looking at its portion of the OBS. The resource breakdown structure (RBS) is a hierarchical list of resources related by category and resource type that is used to facilitate planning and controlling of project work. Each descending (lower) level represents an increasingly detailed description of the resource until small enough to be used in conjunction with the work breakdown structure (WBS) to allow the work to be planned, monitored and controlled. The resource breakdown structure is helpful in tracking project costs and can be aligned with the organization's accounting system. It can contain resource categories other than human resources.

- Matrix-based charts.** A responsibility assignment matrix (RAM) is a grid that shows the project resources assigned to each work package. It is used to illustrate the connections between work packages or activities and project team members. On larger projects, RAMs can be developed at various levels. For example, a high-level RAM can define what a project team group or unit is responsible for within each component of the WBS, while lower-level RAMs are used within the group to designate roles, responsibilities, and levels of authority for specific activities. The matrix format shows all activities associated with one person and all people associated with one activity. This also ensures that there is only one person accountable for any one task to avoid confusion of responsibility. One example of a RAM is a RACI (responsible, accountable, consult, and inform) chart, shown in Figure 9-5. The sample chart shows the work to be done in the left column as activities. The assigned resources can be shown as individuals or groups. The project manager can select other options such as “lead” and “resource” designations or others, as appropriate for the project. A RACI chart is a useful tool to use when the team consists of internal and external resources in order to ensure clear divisions of roles and expectations.

RACI Chart	Person				
Activity	Ann	Ben	Carlos	Dina	Ed
Create charter	A	R	I	I	I
Collect requirements	I	A	R	C	C
Submit change request	I	A	R	R	C
Develop test plan	A	C	I	I	R

R = Responsible A = Accountable C = Consult I = Inform

Figure 9-5. RACI Matrix

- Text-oriented formats.** Team member responsibilities that require detailed descriptions can be specified in text-oriented formats. Usually in outline form, the documents provide information such as responsibilities, authority, competencies, and qualifications. The documents are known by various names including position descriptions and role-responsibility-authority forms. These documents can be used as templates for future projects, especially when the information is updated throughout the current project by applying lessons learned.

9.1.2.2 Networking

Networking is the formal and informal interaction with others in an organization, industry, or professional environment. It is a constructive way to understand political and interpersonal factors that will impact the effectiveness of various staffing management options. Human resource management benefits from successful networking by improving knowledge of and access to human resource assets such as strong competencies, specialized experience, and external partnership opportunities. Examples of human resources networking activities include proactive correspondence, luncheon meetings, informal conversations including meetings and events, trade conferences, and symposia. Networking can be a useful technique at the beginning of a project. It can also be an effective way to enhance project management professional development during the project and after the project ends.

9.1.2.3 Organizational Theory

Organizational theory provides information regarding the way in which people, teams, and organizational units behave. Effective use of common themes identified in organizational theory can shorten the amount of time, cost, and effort needed to create the Plan Human Resource Management process outputs and improve planning efficiency. It is important to recognize that different organizational structures have different individual response, individual performance, and personal relationship characteristics. Also, applicable organizational theories may recommend exercising a flexible leadership style that adapts to the changes in a team's maturity level throughout the project life cycle.

9.1.2.4 Expert Judgment

When developing the human resource management plan, expert judgment is used to:

- List the preliminary requirements for the required skills;
- Assess the roles required for the project based on standardized role descriptions within the organization;
- Determine the preliminary effort level and number of resources needed to meet project objectives;
- Determine reporting relationships needed based on the organizational culture;
- Provide guidelines on lead time required for staffing, based on lessons learned and market conditions;
- Identify risks associated with staff acquisition, retention, and release plans; and
- Identify and recommend programs for complying with applicable government and union contracts.

9.1.2.5 Meetings

When planning human resource management of the project, the project management team will hold planning meetings. These meetings leverage a combination of other tools and techniques to allow for all project management team members to reach consensus on the human resource management plan.

9.1.3 Plan Human Resource Management: Outputs

9.1.3.1 Human Resource Management Plan

The human resource management plan, a part of the project management plan, provides guidance on how project human resources should be defined, staffed, managed, and eventually released. The human resource management plan and any subsequent revisions are also inputs into the Develop Project Management Plan process.

The human resource management plan includes, but is not limited to, the following:

- **Roles and responsibilities.** The following should be addressed when listing the roles and responsibilities needed to complete a project:
 - *Role.* The function assumed by or assigned to a person in the project. Examples of project roles are civil engineer, business analyst, and testing coordinator. Role clarity concerning authority, responsibilities, and boundaries should also be documented.
 - *Authority.* The right to apply project resources, make decisions, sign approvals, accept deliverables, and influence others to carry out the work of the project. Examples of decisions that need clear authority include the selection of a method for completing an activity, quality acceptance, and how to respond to project variances. Team members operate best when their individual levels of authority match their individual responsibilities.
 - *Responsibility.* The assigned duties and work that a project team member is expected to perform in order to complete the project's activities.
 - *Competency.* The skill and capacity required to complete assigned activities within the project constraints. If project team members do not possess required competencies, performance can be jeopardized. When such mismatches are identified, proactive responses such as training, hiring, schedule changes, or scope changes are initiated.

- **Project organization charts.** A project organization chart is a graphic display of project team members and their reporting relationships. It can be formal or informal, highly detailed or broadly framed, based on the needs of the project. For example, the project organization chart for a 3,000-person disaster response team will have greater detail than a project organization chart for an internal, twenty-person project.
- **Staffing management plan.** The staffing management plan is a component of the human resource management plan that describes when and how project team members will be acquired and how long they will be needed. It describes how human resource requirements will be met. The staffing management plan can be formal or informal, highly detailed, or broadly framed, depending upon the needs of the project. The plan is updated continually during the project to direct ongoing team member acquisition and development actions. Information in the staffing management plan varies by application area and project size, but items to consider include:
 - *Staff acquisition.* A number of questions arise when planning the acquisition of project team members. For example, whether the human resources come from within the organization or from external, contracted sources; whether the team members need to work in a central location or may work from distant locations; costs associated with each level of expertise needed for the project; and level of assistance that the organization's human resource department and functional managers are able to provide to the project management team.
 - *Resource calendars.* Calendars that identify the working days and shifts on which each specific resource is available. The staffing management plan describes necessary time frames for project team members, either individually or collectively, as well as when acquisition activities such as recruiting should start. One tool for charting human resources is a resource histogram, used by the project management team as a means of providing a visual representation of resources allocation to all interested parties. This chart illustrates the number of hours a person, department, or entire project team that will be needed each week or month over the course of the project. The chart can include a horizontal line that represents the maximum number of hours available from a particular resource. Bars that extend beyond the maximum available hours identify the need for a resource optimization strategy (Section 6.6.2.4), such as adding more resources or modifying the schedule. An example of a resource histogram is illustrated in Figure 9-6.

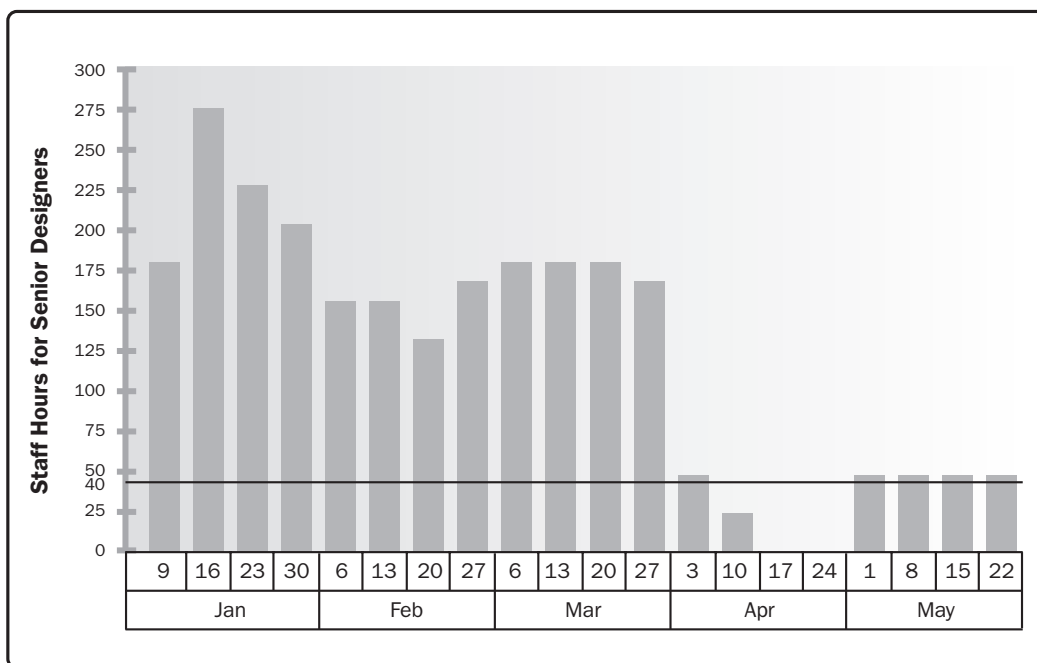

Figure 9-6. Illustrative Resource Histogram

- *Staff release plan.* Determining the method and timing of releasing team members benefits both the project and team members. When team members are released from a project, the costs associated with those resources are no longer charged to the project, thus reducing project costs. Morale is improved when smooth transitions to upcoming projects are already planned. A staff release plan also helps mitigate human resource risks that may occur during or at the end of a project.
- *Training needs.* If it is expected that the team members to be assigned will not have the required competencies, a training plan can be developed as part of the project. The plan can also include ways to help team members obtain certifications that would support their ability to benefit the project.
- *Recognition and rewards.* Clear criteria for rewards and a planned system for their use help promote and reinforce desired behaviors. To be effective, recognition and rewards should be based on activities and performance under a person's control. For example, a team member who is to be rewarded for meeting cost objectives should have an appropriate level of control over decisions that affect expenses. Creating a plan with established times for distribution of rewards ensures that recognition takes place and is not forgotten. Recognition and rewards are part of the Develop Project Team process (Section 9.3).

- *Compliance.* The staffing management plan can include strategies for complying with applicable government regulations, union contracts, and other established human resource policies.
- *Safety.* Policies and procedures that protect team members from safety hazards can be included in the staffing management plan as well as in the risk register.

9.2 Acquire Project Team

Acquire Project Team is the process of confirming human resource availability and obtaining the team necessary to complete project activities. The key benefit of this process consists of outlining and guiding the team selection and responsibility assignment to obtain a successful team. The inputs, tools and techniques, and outputs of this process are depicted in Figure 9-7. Figure 9-8 depicts the data flow diagram of the process.

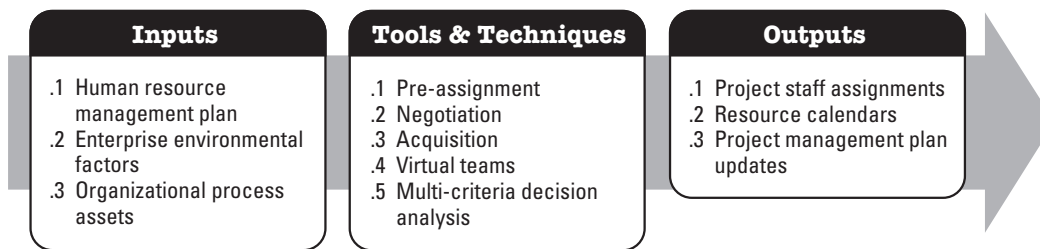

Figure 9-7. Acquire Project Team: Inputs, Tools & Techniques, and Outputs

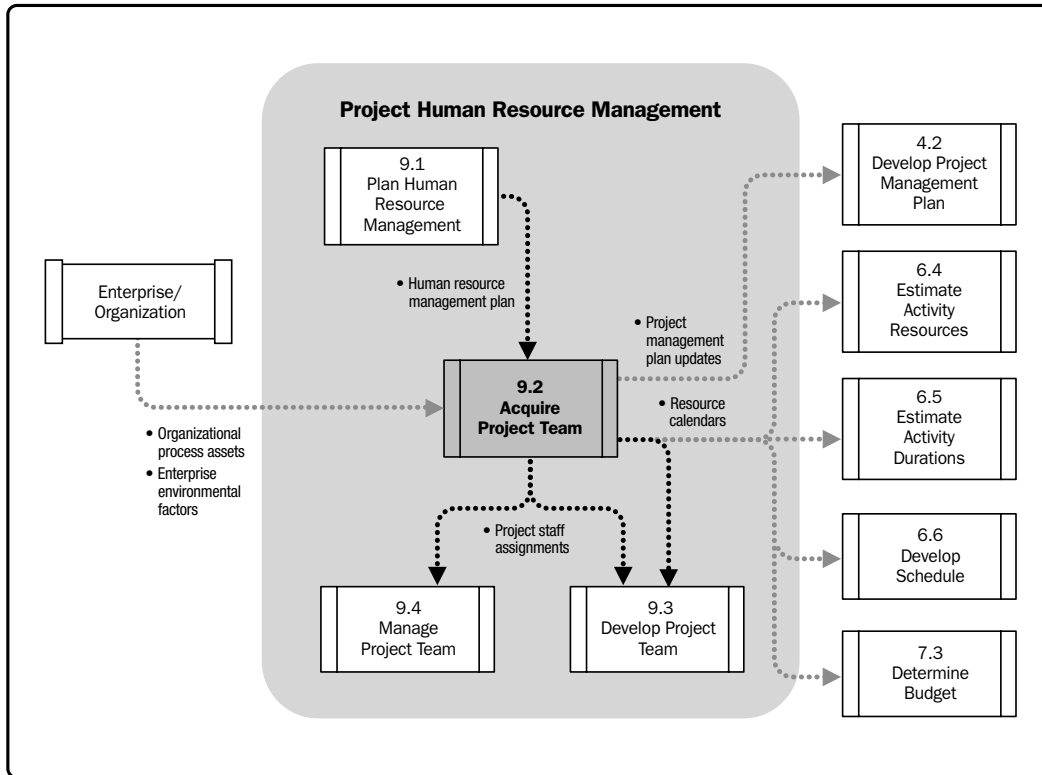

Figure 9-8. Acquire Project Team Data Flow Diagram

The project management team may or may not have direct control over team member selection because of collective bargaining agreements, use of subcontractor personnel, matrix project environment, internal or external reporting relationships, or other various reasons. It is important that the following factors are considered during the process of acquiring the project team:

- The project manager or project management team should effectively negotiate and influence others who are in a position to provide the required human resources for the project.
- Failure to acquire the necessary human resources for the project may affect project schedules, budgets, customer satisfaction, quality, and risks. Insufficient human resources or capabilities decrease the probability of success and, in a worst case scenario, could result in project cancellation.
- If the human resources are not available due to constraints, such as economic factors or previous assignments to other projects, the project manager or project team may be required to assign alternative resources, perhaps with lower competencies, provided there is no violation of legal, regulatory, mandatory, or other specific criteria.

These factors should be considered and planned for in the planning stages of the project. The project manager or project management team will be required to reflect the impact of any unavailability of required human resources in the project schedule, project budget, project risks, project quality, training plans, and the other project management plans.

9.2.1 Acquire Project Team: Inputs

9.2.1.1 Human Resource Management Plan

Described in Section 9.1.3.1. The human resource management plan provides guidance on how project human resources should be identified, staffed, managed, and eventually released. It includes:

- Roles and responsibilities defining the positions, skills, and competencies that the project demands;
- Project organization charts indicating the number of people needed for the project; and
- Staffing management plan delineating the time periods each project team member will be needed and other information important to engage the project team.

9.2.1.2 Enterprise Environmental Factors

Described in Section 2.1.5. The enterprise environmental factors that influence the Acquire Project Team process include, but are not limited to:

- Existing information on human resources including availability, competency levels, prior experience, interest in working on the project and their cost rate;
- Personnel administration policies such as those that affect outsourcing;
- Organizational structure as described in Section 2.3.1; and
- Colocation or multiple locations.

9.2.1.3 Organizational Process Assets

Described in Section 2.1.4. The organizational process assets that influence the Acquire Project Team process include, but are not limited to, organizational standard policies, processes, and procedures.

9.2.2 Acquire Project Team: Tools and Techniques

9.2.2.1 Pre-assignment

When project team members are selected in advance, they are considered pre-assigned. This situation can occur if the project is the result of specific people being identified as part of a competitive proposal, if the project is dependent upon the expertise of particular persons, or if some staff assignments are defined within the project charter.

9.2.2.2 Negotiation

Staff assignments are negotiated on many projects. For example, the project management team may need to negotiate with:

- Functional managers, to ensure that the project receives appropriately competent staff in the required time frame and that the project team members will be able, willing, and authorized to work on the project until their responsibilities are completed;
- Other project management teams within the performing organization, to appropriately assign scarce or specialized human resources; and
- External organizations, vendors, suppliers, contractors, etc., for appropriate, scarce, specialized, qualified, certified, or other such specified human resources. Special consideration should be given to external negotiating policies, practices, processes, guidelines, legal, and other such criteria.

The project management team's ability to influence others plays an important role in negotiating staff assignments, as do the politics of the organizations involved. For example, a functional manager will weigh the benefits and visibility of competing projects when determining where to assign exceptional performers requested by various project teams.

9.2.2.3 Acquisition

When the performing organization is unable to provide the staff needed to complete a project, the required services may be acquired from outside sources. This can involve hiring individual consultants or subcontracting work to another organization.

9.2.2.4 Virtual Teams

The use of virtual teams creates new possibilities when acquiring project team members. Virtual teams can be defined as groups of people with a shared goal who fulfill their roles with little or no time spent meeting face to face. The availability of communication technology such as e-mail, audio conferencing, social media, web-based meetings and video conferencing has made virtual teams feasible. The virtual team model makes it possible to:

- Form teams of people from the same organization who live in widespread geographic areas;
- Add special expertise to a project team even though the expert is not in the same geographic area;
- Incorporate employees who work from home offices;
- Form teams of people who work different shifts, hours, or days;
- Include people with mobility limitations or disabilities; and
- Move forward with projects that would have been ignored due to travel expenses.

There are some disadvantages related to virtual teams, such as possibility for misunderstandings, feeling of isolation, difficulties in sharing knowledge and experience between team members, and cost of appropriate technology. Communication planning becomes increasingly important in a virtual team environment. Additional time may be needed to set clear expectations, facilitate communications, develop protocols for resolving conflict, include people in decision making, understand cultural differences, and share credit in successes.

9.2.2.5 Multi-Criteria Decision Analysis

Selection criteria are often used as a part of acquiring the project team. By use of a multi-criteria decision analysis tool, criteria are developed and used to rate or score potential team members. The criteria are weighted according to the relative importance of the needs within the team. Some examples of selection criteria that can be used to score team members are shown as follows:

- **Availability.** Identify whether the team member is available to work on the project within the time period needed. If there are there any concerns for availability during the project timeline.
- **Cost.** Verify if the cost of adding the team member is within the prescribed budget.
- **Experience.** Verify that the team member has the relevant experience that will contribute to the project success.
- **Ability.** Verify that the team member has the competencies needed by the project.

- **Knowledge.** Consider if the team member has relevant knowledge of the customer, similar implemented projects, and nuances of the project environment.
- **Skills.** Determine whether the member has the relevant skills to use a project tool, implementation, or training.
- **Attitude.** Determine whether the member has the ability to work with others as a cohesive team.
- **International factors.** Consider team member location, time zone and communication capabilities.

9.2.3 Acquire Project Team: Outputs

9.2.3.1 Project Staff Assignments

The project is staffed when appropriate people have been assigned to the team. The documentation of these assignments can include a project team directory, memos to team members, and names inserted into other parts of the project management plan, such as project organization charts and schedules.

9.2.3.2 Resource Calendars

Resource calendars document the time periods that each project team member is available to work on the project. Creating a reliable schedule (Section 6.6.3.1) depends on having a good understanding of each person's availability and schedule constraints, including time zones, work hours, vacation time, local holidays, and commitments to other projects.

9.2.3.3 Project Management Plan Updates

Elements of the project management plan that may be updated include, but are not limited to, the human resource management plan. For example, the person assigned to a predefined role may not fulfill all staffing requirements outlined in the human resource management plan. When gaps occur, the project management plan needs to be updated to change the team structure, roles, or responsibilities.

9.3 Develop Project Team

Develop Project Team is the process of improving competencies, team member interaction, and overall team environment to enhance project performance. The key benefit of this process is that it results in improved teamwork, enhanced people skills and competencies, motivated employees, reduced staff turnover rates, and improved overall project performance. The inputs, tools and techniques, and outputs of this process are depicted in Figure 9-9. Figure 9-10 depicts the data flow diagram of the process.

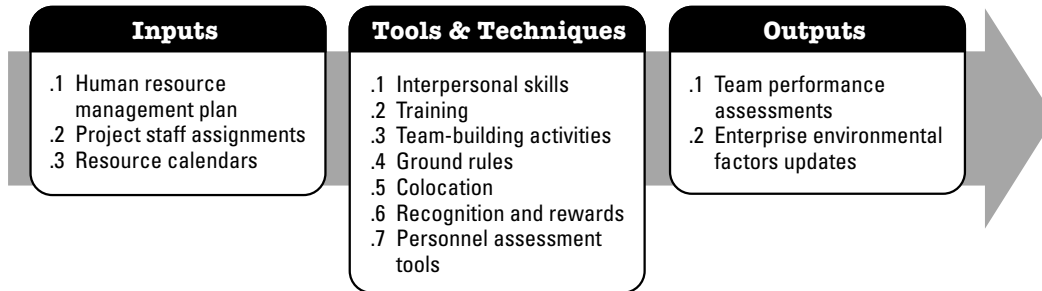

Figure 9-9. Develop Project Team: Inputs, Tools & Techniques, and Outputs

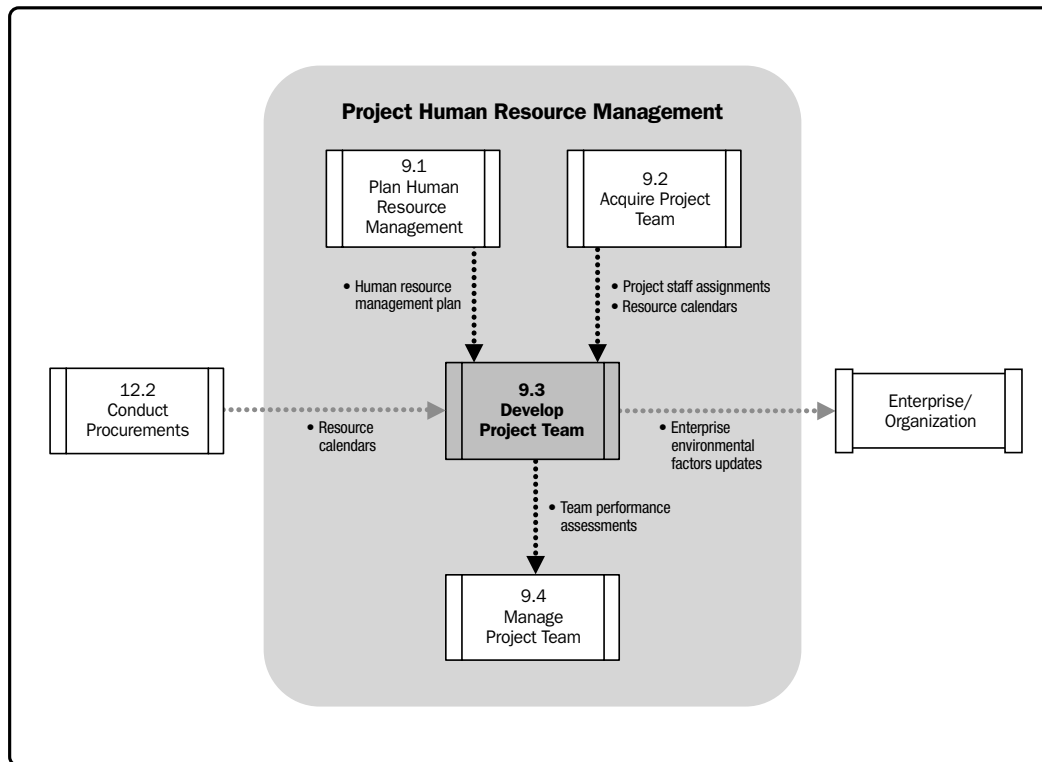

Figure 9-10. Develop Project Team Data Flow Diagram

Project managers should acquire skills to identify, build, maintain, motivate, lead, and inspire project teams to achieve high team performance and to meet the project's objectives. Teamwork is a critical factor for project success, and developing effective project teams is one of the primary responsibilities of the project manager. Project managers should create an environment that facilitates teamwork. Project managers should continually motivate their team by providing challenges and opportunities, by providing timely feedback and support as needed, and by recognizing and rewarding good performance. High team performance can be achieved by using open and effective communication, creating team building opportunities, developing trust among team members, managing conflicts in a constructive manner, and encouraging collaborative problem solving and decision making. The project manager should request management support and/or influence the appropriate stakeholders to acquire the resources needed to develop effective project teams.

Project managers operate in a global environment and work on projects characterized by cultural diversity. Team members often have diverse industry experience, know multiple languages, and sometimes operate in the “team language” that may be a different language or norm than their native one. The project management team should capitalize on cultural differences, focus on developing and sustaining the project team throughout the project life cycle, and promote working together interdependently in a climate of mutual trust. Developing the project team improves the people skills, technical competencies, and overall team environment and project performance. It requires clear, timely, effective, and efficient communication between team members throughout the life of the project. Objectives of developing a project team include, but are not limited to:

- Improving knowledge and skills of team members to increase their ability to complete project deliverables, while lowering costs, reducing schedules, and improving quality;
- Improving feelings of trust and agreement among team members to raise morale, lower conflict, and increase team work; and
- Creating a dynamic, cohesive, and collaborative team culture to (1) improve individual and team productivity, team spirit, and cooperation and (2) allow cross training and mentoring between team members to share knowledge and expertise.

9.3.1 Develop Project Team: Inputs

9.3.1.1 Human Resource Management Plan

Described in Section 9.1.3.1. The human resource management plan provides guidance on how project human resources should be defined, staffed, managed, controlled, and eventually released. It identifies training strategies and plans for developing the project team. Items such as rewards, feedback, additional training, and disciplinary actions can be added to the plan as a result of ongoing team performance assessments and other forms of project team management.

9.3.1.2 Project Staff Assignments

Described in Section 9.2.3.1. Team development starts with a list of the project team members. Project staff assignment documents identify the people who are on the team.

9.3.1.3 Resource Calendars

Described in Section 9.2.3.2. Resource calendars identify times when the project team members can participate in team development activities.

9.3.2 Develop Project Team: Tools and Techniques

9.3.2.1 Interpersonal Skills

Interpersonal skills, sometimes known as “soft skills,” are behavioral competencies that include proficiencies such as communication skills, emotional intelligence, conflict resolution, negotiation, influence, team building, and group facilitation. These soft skills are valuable assets when developing the project team. For example, the project management team can use emotional intelligence to reduce tension and increase cooperation by identifying, assessing, and controlling the sentiments of project team members, anticipating their actions, acknowledging their concerns, and following up on their issues.

9.3.2.2 Training

Training includes all activities designed to enhance the competencies of the project team members. Training can be formal or informal. Examples of training methods include classroom, online, computer-based, on-the-job training from another project team member, mentoring, and coaching. If project team members lack the necessary management or technical skills, such skills can be developed as part of the project work. Scheduled training takes place as stated in the human resource management plan. Unplanned training takes place as a result of observation, conversation, and project performance appraisals conducted during the controlling process of managing the project team. Training costs could be included in the project budget, or supported by performing organization if the added skills may be useful for future projects. It could be performed by in-house or external trainers.

9.3.2.3 Team-Building Activities

Team-building activities can vary from a 5-minute agenda item in a status review meeting to an off-site, professionally facilitated experience designed to improve interpersonal relationships. The objective of team-building activities is to help individual team members work together effectively. Team-building strategies are particularly valuable when team members operate from remote locations without the benefit of face-to-face contact. Informal communication and activities can help in building trust and establishing good working relationships.

As an ongoing process, team building is crucial to project success. While team building is essential during the initial stages of a project, it is a never-ending process. Changes in a project environment are inevitable, and to manage them effectively, a continued or a renewed team-building effort should be applied. The project manager should continually monitor team functionality and performance to determine if any actions are needed to prevent or correct various team problems.

One of the models used to describe team development is the Tuckman ladder (Tuckman, 1965; Tuckman & Jensen, 1977), which includes five stages of development that teams may go through. Although it's common for these stages to occur in order, it's not uncommon for a team to get stuck in a particular stage or slip to an earlier stage. Projects with team members who worked together in the past may skip a stage.

- **Forming.** This phase is where the team meets and learns about the project and their formal roles and responsibilities. Team members tend to be independent and not as open in this phase.
- **Storming.** During this phase, the team begins to address the project work, technical decisions, and the project management approach. If team members are not collaborative and open to differing ideas and perspectives, the environment can become counterproductive.
- **Norming.** In the norming phase, team members begin to work together and adjust their work habits and behaviors to support the team. The team learns to trust each other.
- **Performing.** Teams that reach the performing stage function as a well-organized unit. They are interdependent and work through issues smoothly and effectively.
- **Adjourning.** In the adjourning phase, the team completes the work and moves on from the project. This typically occurs when staff is released from the project as deliverables are completed or as part of carrying out the Close Project or Phase process (Section 4.6).

The duration of a particular stage depends upon team dynamics, team size, and team leadership. Project managers should have a good understanding of team dynamics in order to move their team members through all stages in an effective manner.

9.3.2.4 Ground Rules

Ground rules establish clear expectations regarding acceptable behavior by project team members. Early commitment to clear guidelines decreases misunderstandings and increases productivity. Discussing ground rules in areas such as code of conduct, communication, working together, or meeting etiquette allows team members to discover values that are important to one another. All project team members share responsibility for enforcing the rules once they are established.

9.3.2.5 Colocation

Colocation, also referred to as “tight matrix,” involves placing many or all of the most active project team members in the same physical location to enhance their ability to perform as a team. Colocation can be temporary, such as at strategically important times during the project, or for the entire project. Colocation strategies can include a team meeting room (sometimes called “war room”), places to post schedules, and other conveniences that enhance communication and a sense of community. While colocation is considered a good strategy, the use of virtual teams can bring benefits such as the use of more skilled resources, reduced costs, less travel, and relocation expenses and the proximity of team members to suppliers, customers, or other key stakeholders.

9.3.2.6 Recognition and Rewards

Part of the team development process involves recognizing and rewarding desirable behavior. The original plans concerning ways in which to reward people are developed during the Plan Human Resource Management process. It is important to recognize that a particular reward given to any individual will be effective only if it satisfies a need which is valued by that individual. Award decisions are made, formally or informally, during the process of managing the project team through project performance appraisals (Section 9.4.2.2). Cultural differences should be considered when determining recognition and rewards.

People are motivated if they feel they are valued in the organization and this value is demonstrated by the rewards given to them. Generally, money is viewed as a tangible aspect of any reward system, but intangible rewards could be equally or even more effective. Most project team members are motivated by an opportunity to grow, accomplish, and apply their professional skills to meet new challenges. A good strategy for project managers is to give the team recognition throughout the life cycle of the project rather than waiting until the project is completed.

9.3.2.7 Personnel Assessment Tools

Personnel assessment tools give the project manager and the project team insight into areas of strength and weakness. These tools help project managers assess the team preferences, aspirations, how they process and organize information, how they tend to make decisions, and how they prefer to interact with people.

Various tools are available such as attitudinal surveys, specific assessments, structured interviews, ability tests, and focus groups. These tools can provide improved understanding, trust, commitment, and communications among team members and facilitate more productive teams throughout the project.

9.3.3 Develop Project Team: Outputs

9.3.3.1 Team Performance Assessments

As project team development efforts such as training, team building, and colocation are implemented, the project management team makes formal or informal assessments of the project team's effectiveness. Effective team development strategies and activities are expected to increase the team's performance, which increases the likelihood of meeting project objectives. Team performance assessment criteria should be determined by all appropriate parties and incorporated in the Develop Project Team inputs.

The performance of a successful team is measured in terms of technical success according to agreed-upon project objectives (including quality levels), performance on project schedule (finished on time), and performance on budget (finished within financial constraints). High-performance teams are characterized by these task-oriented and results-oriented outcomes.

The evaluation of a team's effectiveness may include indicators such as:

- Improvements in skills that allow individuals to perform assignments more effectively,
- Improvements in competencies that help the team perform better as a team,
- Reduced staff turnover rate, and
- Increased team cohesiveness where team members share information and experiences openly and help each other to improve the overall project performance.

As a result of conducting an evaluation of the team's overall performance, the project management team can identify the specific training, coaching, mentoring, assistance, or changes required to improve the team's performance. This should also include identification of the appropriate or required resources necessary to achieve and implement the improvements identified in the assessment. These resources and recommendations for team improvement should be well documented and forwarded to the relevant parties.

9.3.3.2 Enterprise Environmental Factors Updates

The enterprise environmental factors that may be updated as a result of the Develop Project Team process include, but are not limited to, personnel administration, employee training records, and skill assessments.

9.4 Manage Project Team

Manage Project Team is the process of tracking team member performance, providing feedback, resolving issues, and managing team changes to optimize project performance. The key benefit of this process is that it influences team behavior, manages conflict, resolves issues, and appraises team member performance. The inputs, tools and techniques, and outputs of this process are depicted in Figure 9-11. Figure 9-12 depicts the data flow diagram of the process.

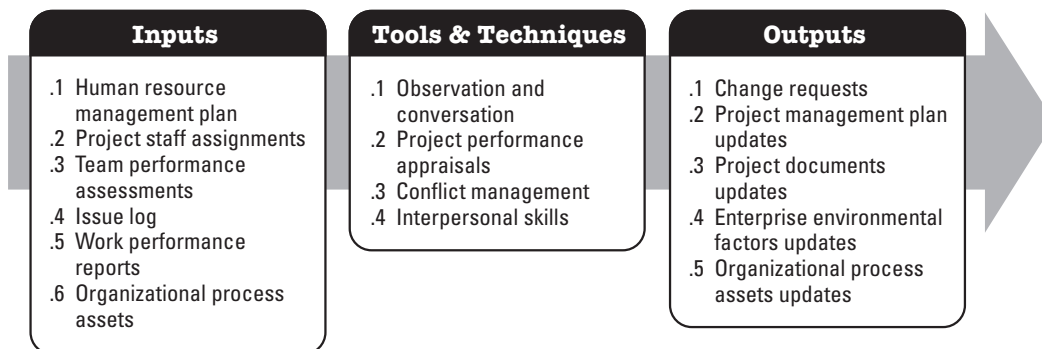

Figure 9-11. Manage Project Team: Inputs, Tools & Techniques, and Outputs

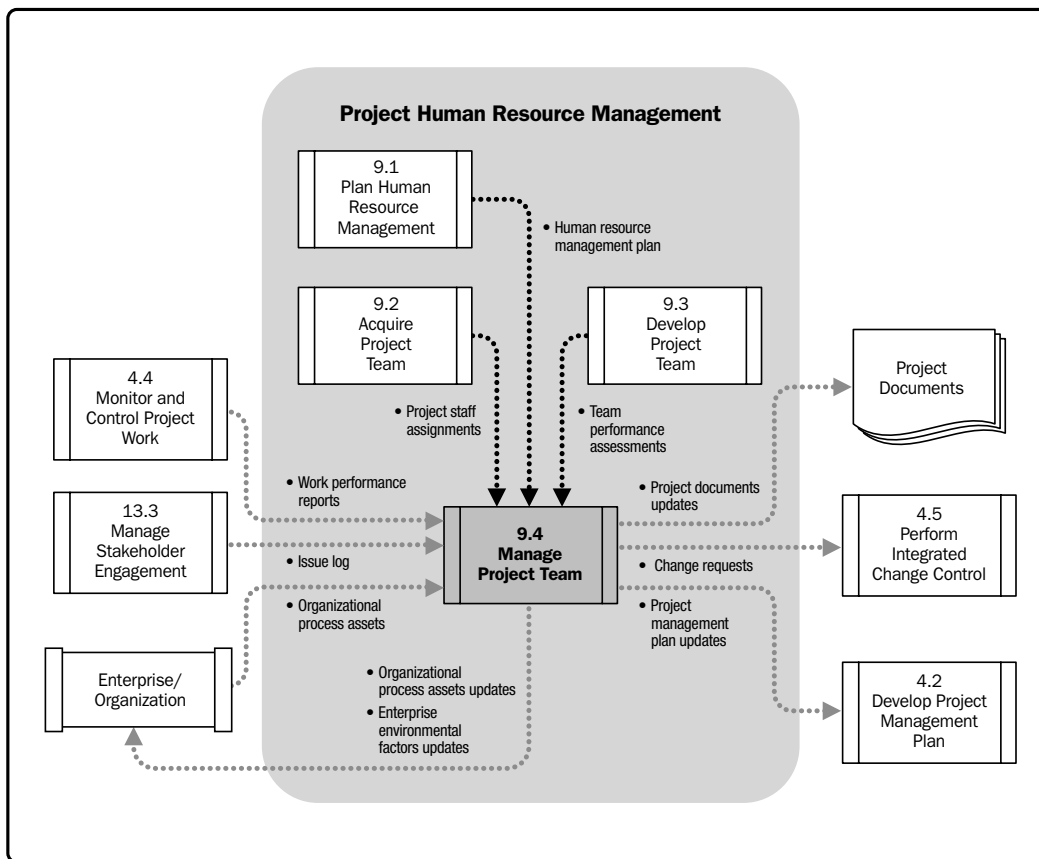

Figure 9-12. Manage Project Team Data Flow Diagram

As a result of managing the project team, change requests are submitted, the human resource management plan is updated, issues are resolved, input is provided for performance appraisals, and lessons learned are added to the organization’s database.

Managing the project team requires a variety of management skills for fostering teamwork and integrating the efforts of team members to create high-performance teams. Team management involves a combination of skills with special emphasis on communication, conflict management, negotiation, and leadership. Project managers should provide challenging assignments to team members and provide recognition for high performance.

9.4.1 Manage Project Team: Inputs

9.4.1.1 Human Resource Management Plan

Described in Section 9.1.3.1. The human resource management plan provides guidance on how project human resources should be defined, staffed, managed, controlled, and eventually released. It includes, but is not limited to:

- Roles and responsibilities,
- Project organization, and
- Staffing management plan.

9.4.1.2 Project Staff Assignments

Described in Section 9.2.3.1. Project staff assignments provide documentation, which includes the list of project team members.

9.4.1.3 Team Performance Assessments

Described in Section 9.3.3.1. The project management team makes ongoing formal or informal assessments of the project team's performance. By continually assessing the project team's performance, actions can be taken to resolve issues, modify communication, address conflict, and improve team interaction.

9.4.1.4 Issue Log

Issues arise in the course of managing the project team. An issue log can be used to document and monitor who is responsible for resolving specific issues by a target date.

9.4.1.5 Work Performance Reports

Described in Section 4.4.3.2. Work performance reports provide documentation about the current project status compared to project forecasts. Performance areas that can help with project team management include results from schedule control, cost control, quality control, and scope validation. The information from performance reports and related forecasts assists in determining future human resource requirements, recognition and rewards, and updates to the staffing management plan.

9.4.1.6 Organizational Process Assets

Described in Section 2.1.4. The organizational process assets that can influence the Manage Project Team process include, but are not limited to:

- Certificates of appreciation,
- Newsletters,
- Websites,
- Bonus structures,
- Corporate apparel, and
- Other organizational perquisites.

9.4.2 Manage Project Team: Tools and Techniques

9.4.2.1 Observation and Conversation

Observation and conversation are used to stay in touch with the work and attitudes of project team members. The project management team monitors progress toward project deliverables, accomplishments that are a source of pride for team members, and interpersonal issues.

9.4.2.2 Project Performance Appraisals

Objectives for conducting performance appraisals during the course of a project can include clarification of roles and responsibilities, constructive feedback to team members, discovery of unknown or unresolved issues, development of individual training plans, and the establishment of specific goals for future time periods.

The need for formal or informal project performance appraisals depends on the length of the project, complexity of the project, organizational policy, labor contract requirements, and the amount and quality of regular communication.

9.4.2.3 Conflict Management

Conflict is inevitable in a project environment. Sources of conflict include scarce resources, scheduling priorities, and personal work styles. Team ground rules, group norms, and solid project management practices, like communication planning and role definition, reduce the amount of conflict.

Successful conflict management results in greater productivity and positive working relationships. When managed properly, differences of opinion can lead to increased creativity and better decision making. If the differences become a negative factor, project team members are initially responsible for their resolution. If conflict escalates, the project manager should help facilitate a satisfactory resolution. Conflict should be addressed early and usually in private, using a direct, collaborative approach. If disruptive conflict continues, formal procedures may be used, including disciplinary actions.

The success of project managers in managing their project teams often depends a great deal on their ability to resolve conflict. Different project managers may utilize different conflict resolution methods. Factors that influence conflict resolution methods include:

- Relative importance and intensity of the conflict,
- Time pressure for resolving the conflict,
- Position taken by persons involved, and
- Motivation to resolve conflict on a long-term or a short-term basis.

There are five general techniques for resolving conflict. As each one has its place and use, these are not given in any particular order:

- **Withdraw/Avoid.** Retreating from an actual or potential conflict situation; postponing the issue to be better prepared or to be resolved by others.
- **Smooth/Accommodate.** Emphasizing areas of agreement rather than areas of difference; conceding one's position to the needs of others to maintain harmony and relationships.
- **Compromise/Reconcile.** Searching for solutions that bring some degree of satisfaction to all parties in order to temporarily or partially resolve the conflict.
- **Force/Direct.** Pushing one's viewpoint at the expense of others; offering only win-lose solutions, usually enforced through a power position to resolve an emergency.
- **Collaborate/Problem Solve.** Incorporating multiple viewpoints and insights from differing perspectives; requires a cooperative attitude and open dialogue that typically leads to consensus and commitment.

9.4.2.4 Interpersonal Skills

Project managers use a combination of technical, personal, and conceptual skills to analyze situations and interact appropriately with team members. Using appropriate interpersonal skills allows project managers to capitalize on the strengths of all team members.

Examples of interpersonal skills that a project manager uses most often include:

- **Leadership.** Successful projects require strong leadership skills. Leadership is important through all phases of the project life cycle. There are multiple leadership theories defining leadership styles that should be used as needed for each situation or team. It is especially important to communicate the vision and inspire the project team to achieve high performance.
- **Influencing.** Because project managers often have little or no direct authority over team members in a matrix environment, their ability to influence stakeholders on a timely basis is critical to project success. Key influencing skills include:
 - Ability to be persuasive and clearly articulate points and positions;
 - High levels of active and effective listening skills;
 - Awareness of, and consideration for, the various perspectives in any situation; and
 - Gathering relevant and critical information to address important issues and reach agreements while maintaining mutual trust.
- **Effective decision making.** This involves the ability to negotiate and influence the organization and the project management team. Some guidelines for decision making include:
 - Focus on goals to be served,
 - Follow a decision-making process,
 - Study the environmental factors,
 - Analyze available information,
 - Develop personal qualities of the team members,
 - Stimulate team creativity, and
 - Manage risk.

9.4.3 Manage Project Team: Outputs

9.4.3.1 Change Requests

Staffing changes, whether by choice or by uncontrollable events, can affect the rest of the project management plan. When staffing issues disrupt the project team from adhering to the project management plan such as causing the schedule to be extended or the budget to be exceeded, a change request can be processed through the Perform Integrated Change Control process. Staffing changes may include moving people to different assignments, outsourcing some of the work, and replacing team members who leave.

Preventive actions are those actions that are developed to reduce the probability and/or impact of problems before they occur. These actions may include cross training to reduce problems during project team member absences and additional role clarification to ensure all responsibilities are fulfilled.

9.4.3.2 Project Management Plan Updates

Elements of the project management plan that may be updated include, but are not limited to, the human resource management plan.

9.4.3.3 Project Documents Updates

Project documents that may indirectly be updated include, but are not limited to:

- Issue log,
- Roles description, and
- Project staff assignments.

9.4.3.4 Enterprise Environmental Factors Updates

Enterprise environmental factors that may require updates as a result of the Manage Project Team process include, but are not limited to:

- Input to organizational performance appraisals, and
- Personnel skill updates.

9.4.3.5 Organizational Process Assets Updates

Organizational process assets that may require updates as a result of the Manage Project Team process include, but are not limited to:

- Historical information and lessons learned documentation,
- Templates, and
- Organizational standard processes.

10

PROJECT COMMUNICATIONS MANAGEMENT

Project Communications Management includes the processes that are required to ensure timely and appropriate planning, collection, creation, distribution, storage, retrieval, management, control, monitoring, and the ultimate disposition of project information. Project managers spend most of their time communicating with team members and other project stakeholders, whether they are internal (at all organizational levels) or external to the organization. Effective communication creates a bridge between diverse stakeholders who may have different cultural and organizational backgrounds, different levels of expertise, and different perspectives and interests, which impact or have an influence upon the project execution or outcome.

Figure 10-1 provides an overview of the Project Communications Management processes, which are as follows:

10.1 Plan Communications Management—The process of developing an appropriate approach and plan for project communications based on stakeholder’s information needs and requirements, and available organizational assets.

10.2 Manage Communications—The process of creating, collecting, distributing, storing, retrieving and the ultimate disposition of project information in accordance with the communications management plan.

10.3 Control Communications—The process of monitoring and controlling communications throughout the entire project life cycle to ensure the information needs of the project stakeholders are met.

These processes interact with each other and with processes in other Knowledge Areas as described in detail in Section 3 and Annex A1.

The communication activities involved in these processes may often have many potential dimensions that need to be considered, including, but not limited to:

- Internal (within the project) and external (customer, vendors, other projects, organizations, the public);
- Formal (reports, minutes, briefings) and informal (emails, memos, ad-hoc discussions);
- Vertical (up and down the organization) and horizontal (with peers);
- Official (newsletters, annual report) and unofficial (off the record communications); and
- Written and oral, and verbal (voice inflections) and nonverbal (body language).

Most communication skills are common for both general management and project management, such as, but not limited to:

- Listening actively and effectively;
- Questioning and probing ideas and situations to ensure better understanding;
- Educating to increase team’s knowledge so that they can be more effective;
- Fact-finding to identify or confirm information;
- Setting and managing expectations;
- Persuading a person, a team, or an organization to perform an action;
- Motivating to provide encouragement or reassurance;
- Coaching to improve performance and achieve desired results;
- Negotiating to achieve mutually acceptable agreements between parties;
- Resolving conflict to prevent disruptive impacts; and
- Summarizing, recapping, and identifying the next steps.

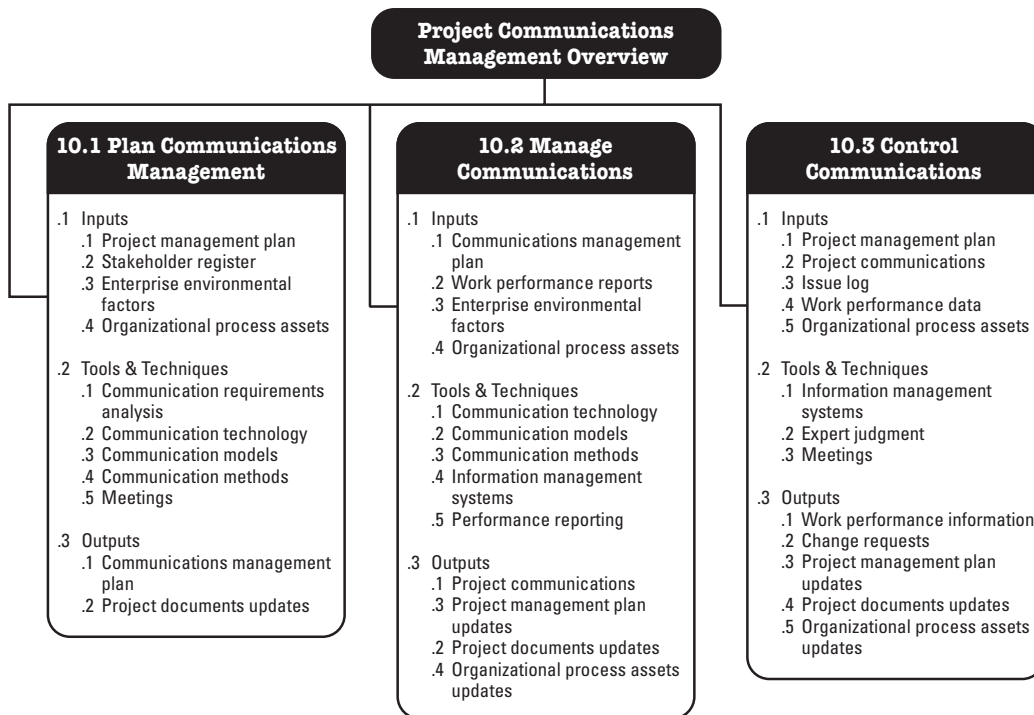

Figure 10-1. Project Communications Management Overview

10.1 Plan Communications Management

Plan Communications Management is the process of developing an appropriate approach and plan for project communications based on stakeholder's information needs and requirements, and available organizational assets. The key benefit of this process is that it identifies and documents the approach to communicate most effectively and efficiently with stakeholders. The inputs, tools and techniques, and outputs of this process are depicted in Figure 10-2. Figure 10-3 depicts the data flow diagram of the Plan Communications Management process.

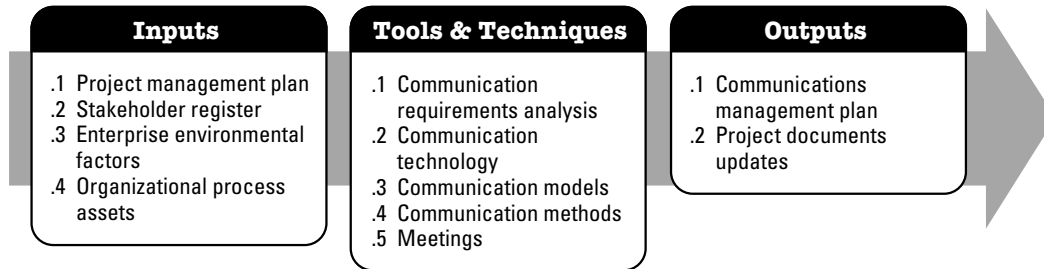

Figure 10-2. Plan Communications Management: Inputs, Tools & Techniques, and Outputs

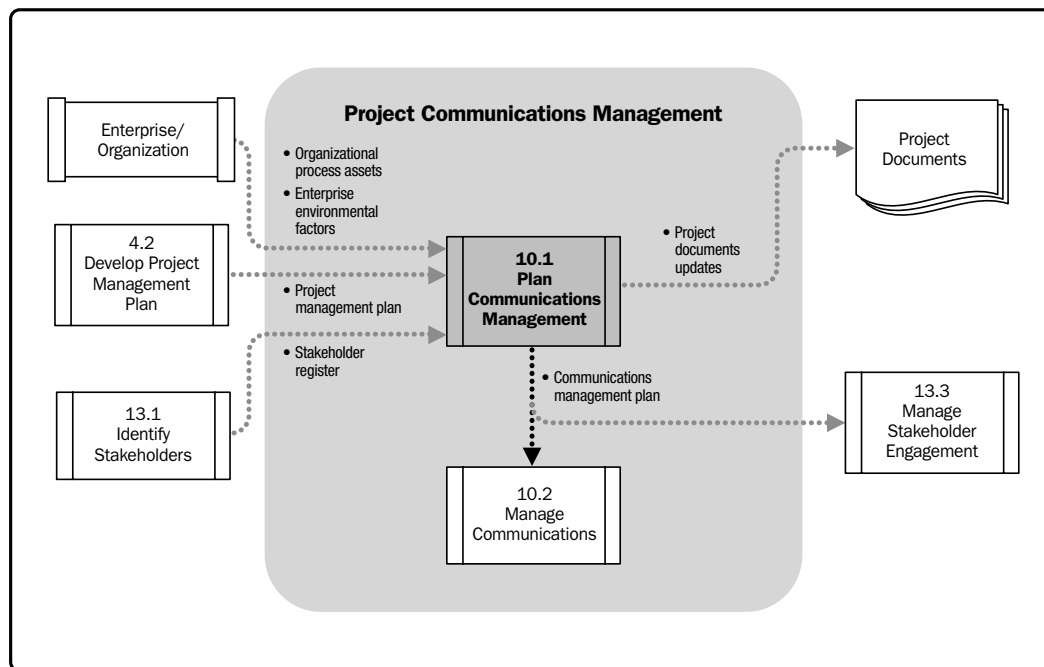

Figure 10-3. Plan Communications Management Data Flow Diagram

Planning the project communications is important to the ultimate success of any project. Inadequate communications planning may lead to problems such as delay in message delivery, communication of information to the wrong audience, or insufficient communication to the stakeholders and misunderstanding or misinterpretation of the message communicated.

On most projects, communication planning is performed very early, such as during project management plan development. This allows appropriate resources, such as time and budget, to be allocated to communication activities. Effective communication means that the information is provided in the right format, at the right time, to the right audience, and with the right impact. Efficient communication means providing only the information that is needed.

While all projects share the need to communicate project information, the information needs and methods of distribution may vary widely. In addition, the methods of storage, retrieval, and ultimate disposition of the project information need to be considered and appropriately documented during this process. Important considerations that may need to be taken into account include, but are not limited to:

- Who needs what information, and who is authorized to access that information;
- When they will need the information;
- Where the information should be stored;
- What format the information should be stored in;
- How the information can be retrieved; and
- Whether time zone, language barriers, and cross-cultural considerations need to be taken into account.

The results of the Plan Communications Management process should be reviewed regularly throughout the project and revised as needed to ensure continued applicability.

10.1.1 Plan Communications Management: Inputs

10.1.1.1 Project Management Plan

Described in Section 4.2.3.1. The project management plan provides information on how the project will be executed, monitored, controlled, and closed.

10.1.1.2 Stakeholder Register

Described in Section 13.1.3.1. The stakeholder register provides the information needed to plan the communication with project stakeholders.

10.1.1.3 Enterprise Environmental Factors

Described in Section 2.1.5. The Plan Communications Management process is tightly linked with enterprise environmental factors, since the structure of an organization will have a major effect on the project's communication requirements. All enterprise environmental factors described in Section 2.1.5 are used as inputs for this process, since communications need to be adapted to the project environment.

10.1.1.4 Organizational Process Assets

Described in Section 2.1.4. All organizational process assets described in Section 2.1.4 are used as inputs to the Plan Communications Management process. Of these, lessons learned and historical information are of particular importance because they can provide insights on both the decisions taken regarding communications issues and the results of those decisions in previous similar projects. These can be used as guiding information to plan the communication activities for the current project.

10.1.2 Plan Communications Management: Tools and Techniques

10.1.2.1 Communication Requirements Analysis

The analysis of the communication requirements determines the information needs of the project stakeholders. These requirements are defined by combining the type and format of information needed with an analysis of the value of that information. Project resources should be expended only on communicating information that contributes to the success of the project or where a lack of communication can lead to failure.

The project manager should also consider the number of potential communication channels or paths as an indicator of the complexity of a project's communications. The total number of potential communication channels is $n(n - 1)/2$, where n represents the number of stakeholders. For example, a project with 10 stakeholders has $10(10 - 1)/2 = 45$ potential communication channels. As a result, a key component of planning the project's actual communications is to determine and limit who will communicate with whom and who will receive what information.

Sources of information typically used to identify and define project communication requirements include, but are not limited to:

- Organizational charts;
- Project organization and stakeholder responsibility relationships;
- Disciplines, departments, and specialties involved in the project;
- Logistics of how many persons will be involved with the project and at which locations;
- Internal information needs (e.g., when communicating within organizations);
- External information needs (e.g., when communicating with the media, public, or contractors); and
- Stakeholder information and communication requirements from within the stakeholder register.

10.1.2.2 Communication Technology

The methods used to transfer information among project stakeholders may vary significantly. For example, a project team may use techniques from brief conversations to extended meetings, or from simple written documents to extensive materials (e.g., schedules, databases, and websites), which are accessible online as methods of communication.

Factors that can affect the choice of communication technology include:

- **Urgency of the need for information.** There is a need to consider the urgency, frequency, and format of the information to be communicated as they may vary from project to project and also within different stages of a project.
- **Availability of technology.** There is a need to ensure that the technology that is required to facilitate communication is compatible, available, and accessible for all stakeholders throughout the life of the project.

- **Ease of Use.** There is a need to ensure that the choice of communication technologies is suitable for project participants and that appropriate training events are planned for, where appropriate.
- **Project environment.** There is a need to determine if the team will meet and operate on a face-to-face basis or in a virtual environment; whether they will be located in one or multiple time zones; whether they will use multiple languages for communication; and finally, whether there are any other project environmental factors, such as culture, which may affect communications.
- **Sensitivity and confidentiality of the information.** There is a need to determine if the information to be communicated is sensitive or confidential and whether or not additional security measures need to be taken. Also, the most appropriate way to communicate the information should be considered.

10.1.2.3 Communication Models

The communication models used to facilitate communications and the exchange of information may vary from project to project and also within different stages of the same project. A basic communication model, shown in Figure 10-4, consists of two parties, defined as the sender and receiver. Medium is the technology medium and includes the mode of communication while noise includes any interference or barriers that might compromise the delivery of the message. The sequence of steps in a basic communication model is:

- **Encode.** Thoughts or ideas are translated (encoded) into language by the sender.
- **Transmit Message.** This information is then sent by the sender using communication channel (medium). The transmission of this message may be compromised by various factors (e.g., distance, unfamiliar technology, inadequate infrastructure, cultural difference, and lack of background information). These factors are collectively termed as noise.
- **Decode.** The message is translated by the receiver back into meaningful thoughts or ideas.
- **Acknowledge.** Upon receipt of a message, the receiver may signal (acknowledge) receipt of the message but this does not necessarily mean agreement with or comprehension of the message.
- **Feedback/Response.** When the received message has been decoded and understood, the receiver encodes thoughts and ideas into a message and then transmits this message to the original sender.

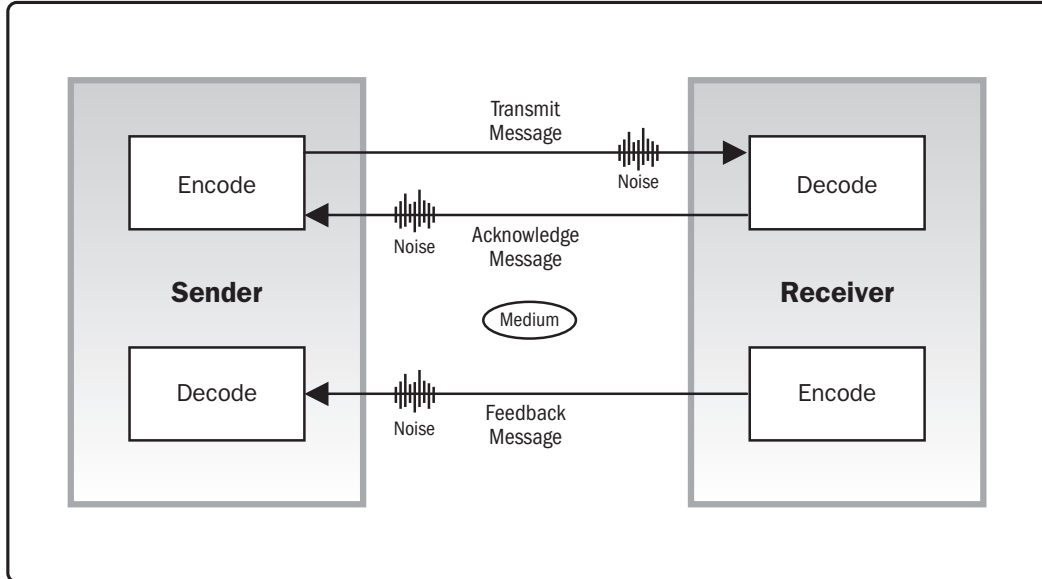

Figure 10-4. Basic Communication Model

The components of the basic communication model need to be considered when project communications are discussed. As part of the communications process, the sender is responsible for the transmission of the message, ensuring the information being communicated is clear and complete, and confirming the communication is correctly understood. The receiver is responsible for ensuring that the information is received in its entirety, understood correctly, and acknowledged or responded to appropriately.

There are many challenges in using these components to effectively communicate with project stakeholders, such as in a highly technical, multinational project team. Successful communication of a technical concept from one team member to another team member in a different country could involve encoding the message in the appropriate language, sending the message using a variety of technologies, and having the receiver decode the message into his or her native language and then reply or provide feedback. Any noise introduced along the way may compromise the original meaning of the message. In this example, there are multiple factors that may lead to the intended meaning of the message being misunderstood or misinterpreted.

10.1.2.4 Communication Methods

There are several communication methods that are used to share information among project stakeholders. These methods are broadly classified as follows:

- **Interactive communication.** Between two or more parties performing a multidirectional exchange of information. It is the most efficient way to ensure a common understanding by all participants on specified topics, and includes meetings, phone calls, instant messaging, video conferencing, etc.
- **Push communication.** Sent to specific recipients who need to receive the information. This ensures that the information is distributed but does not ensure that it actually reached or was understood by the intended audience. Push communications include letters, memos, reports, emails, faxes, voice mails, blogs, press releases, etc.
- **Pull communication.** Used for very large volumes of information, or for very large audiences, and requires the recipients to access the communication content at their own discretion. These methods include intranet sites, e-learning, lessons learned databases, knowledge repositories, etc.

The choices of communication methods that are used for a project may need to be discussed and agreed upon by the project stakeholders based on communication requirements; cost and time constraints; and familiarity and availability of the required tools and resources that may be applicable to the communications process.

10.1.2.5 Meetings

Described in Section 4.3.2.3. The Plan Communications Management process requires discussion and dialogue with the project team to determine the most appropriate way to update and communicate project information, and to respond to requests from various stakeholders for that information. These discussions and dialogue are commonly facilitated through meetings, which may be conducted face to face or online and in different locations, such as the project site or the customer's site.

There are several types of project-related meetings where project communications may occur. Most project meetings consist of stakeholders coming together for the purpose of resolving problems or making decisions. Although casual discussions may be construed as a meeting, most project meetings are more formal with a prearranged time, place, and agenda. Typical meetings begin with a defined list of issues to be discussed, which are circulated in advance with minutes and other information documented specifically for the meeting. This information is then disseminated to other appropriate stakeholders on an as-needed basis.

10.1.3 Plan Communications Management: Outputs

10.1.3.1 Communications Management Plan

The communications management plan is a component of the project management plan that describes how project communications will be planned, structured, monitored, and controlled. The plan contains the following information:

- Stakeholder communication requirements;
- Information to be communicated, including language, format, content, and level of detail;
- Reason for the distribution of that information;
- Time frame and frequency for the distribution of required information and receipt of acknowledgment or response, if applicable;
- Person responsible for communicating the information;
- Person responsible for authorizing release of confidential information;
- Person or groups who will receive the information;
- Methods or technologies used to convey the information, such as memos, e-mail, and/or press releases;
- Resources allocated for communication activities, including time and budget;
- Escalation process identifying time frames and the management chain (names) for escalation of issues that cannot be resolved at a lower staff level;
- Method for updating and refining the communications management plan as the project progresses and develops;
- Glossary of common terminology;
- Flow charts of the information flow in the project, workflows with possible sequence of authorization, list of reports, and meeting plans, etc.; and
- Communication constraints usually derived from a specific legislation or regulation, technology, and organizational policies, etc.

The communications management plan can also include guidelines and templates for project status meetings, project team meetings, e-meetings, and e-mail messages. The use of a project website and project management software can also be included if these are to be used in the project.

10.1.3.2 Project Documents Updates

Project documents that may be updated include, but are not limited to:

- Project schedule, and
- Stakeholder register.

10.2 Manage Communications

Manage Communications is the process of creating, collecting, distributing, storing, retrieving, and the ultimate disposition of project information in accordance to the communications management plan. The key benefit of this process is that it enables an efficient and effective communications flow between project stakeholders. The inputs, tools and techniques, and outputs of this process are depicted in Figure 10-5. Figure 10-6 depicts the data flow diagram of the Manage Communications process.

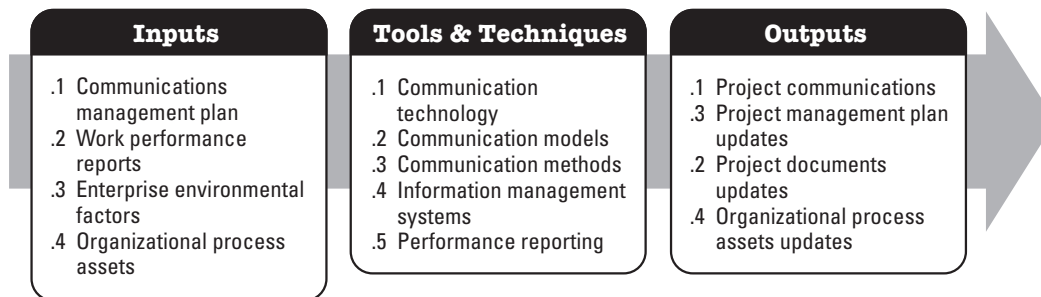

Figure 10-5. Manage Communications: Inputs, Tools & Techniques, and Outputs

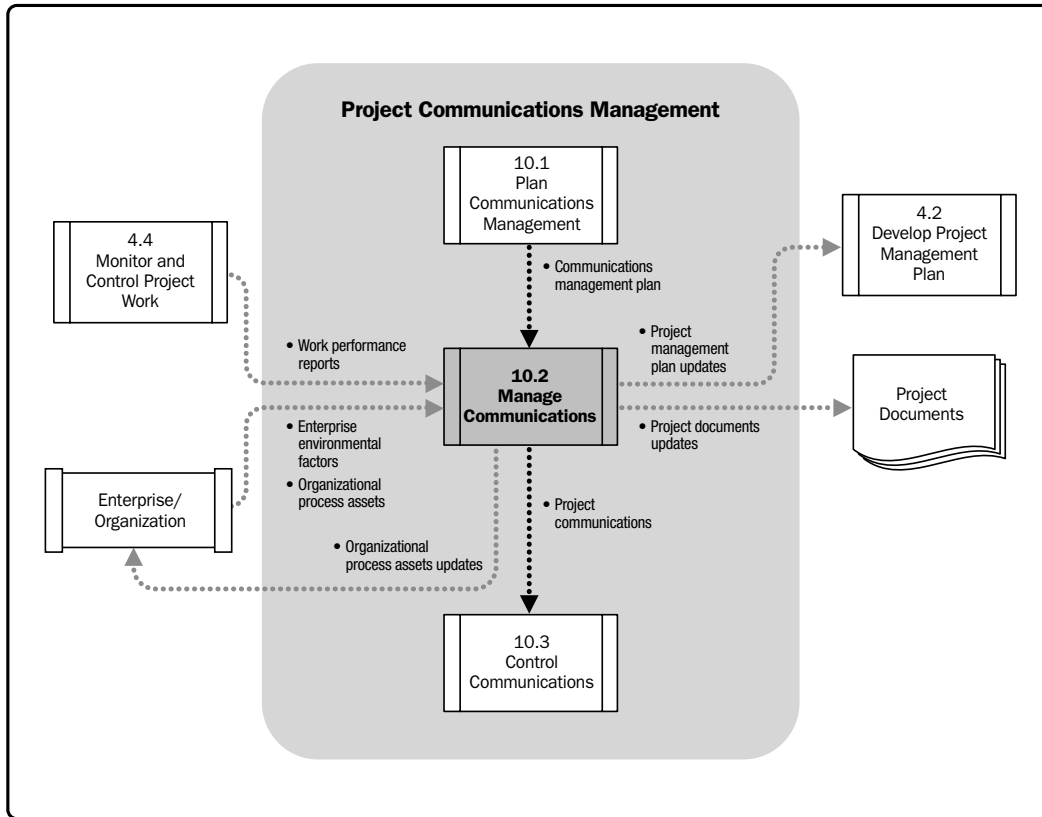

Figure 10-6. Manage Communications Data Flow Diagram

This process goes beyond the distribution of relevant information and seeks to ensure that the information being communicated to project stakeholders has been appropriately generated, as well as received and understood. It also provides opportunities for stakeholders to make requests for further information, clarification, and discussion. Techniques and considerations for effective communications management include, but are not limited to, the following:

- **Sender-receiver models.** Incorporating feedback loops to provide opportunities for interaction/participation and remove barriers to communication.
- **Choice of media.** Situation specifics as to when to communicate in writing versus orally, when to prepare an informal memo versus a formal report, and when to communicate face to face versus by e-mail.
- **Writing style.** Appropriate use of active versus passive voice, sentence structure, and word choice.

- **Meeting management techniques.** Preparing an agenda and dealing with conflicts.
- **Presentation techniques.** Awareness of the impact of body language and design of visual aids.
- **Facilitation techniques.** Building consensus and overcoming obstacles.
- **Listening techniques.** Listening actively (acknowledging, clarifying, and confirming understanding) and removal of barriers that adversely affect comprehension.

10.2.1 Manage Communications: Inputs

10.2.1.1 Communications Management Plan

Described in Section 10.1.3.1. The communications management plan describes how project communications will be planned, structured, monitored, and controlled.

10.2.1.2 Work Performance Reports

Described in Section 4.4.3.2. Work performance reports are a collection of project performance and status information that may be used to facilitate discussion and to create communications. To optimize this process, it is important that reports be comprehensive, accurate, and available in a timely manner.

10.2.1.3 Enterprise Environmental Factors

Described in Section 2.1.5. Specific enterprise environmental factors that can influence the Manage Communications process include, but are not limited to:

- Organizational culture and structure,
- Government or industry standards and regulations, and
- Project management information system.

10.2.1.4 Organizational Process Assets

Described in Section 2.1.4. Organizational process assets that can influence the Manage Communications process include, but are not limited to:

- Policies, procedures, processes, and guidelines regarding communications management;
- Templates; and
- Historical information and lessons learned.

10.2.2 Manage Communications: Tools and Techniques

10.2.2.1 Communication Technology

Described in Section 10.1.2.2. The choice of communication technology is an important consideration in the Manage Communications process. As this can vary significantly from project to project and also throughout the life of a project, the focus is to ensure that the choice is appropriate for the information that is being communicated.

10.2.2.2 Communication Models

Described in Section 10.1.2.3. The choice of communication models is an important consideration in this process. As the components in the communications all contribute toward an effective and efficient communications process, the focus is to ensure that the choice of the communication model is appropriate for the project that is undertaken and that any barriers (noise) are identified and managed.

10.2.2.3 Communication Methods

Described in Section 10.1.2.4. The choice of communication methods is an important consideration in this process. As there can be many potential barriers and challenges during this process, the focus is to ensure that the information that has been created and distributed has been received and understood to enable response and feedback.

10.2.2.4 Information Management Systems

Project information is managed and distributed using a variety of tools, including:

- Hard-copy document management: letters, memos, reports, and press releases;
- Electronic communications management: e-mail, fax, voice mail, telephone, video and web conferencing, websites, and web publishing; and
- Electronic project management tools: web interfaces to scheduling and project management software, meeting and virtual office support software, portals, and collaborative work management tools.

10.2.2.5 Performance Reporting

Performance reporting is the act of collecting and distributing performance information, including status reports, progress measurements, and forecasts. Performance reporting involves the periodic collection and analysis of baseline versus actual data to understand and communicate the project progress and performance as well as to forecast the project results.

Performance reporting needs to provide information at an appropriate level for each audience. The format may range from a simple status report to more elaborate reports and may be prepared regularly or on an exception basis. A simple status report might show performance information, such as percent complete or status dashboards for each area (i.e., scope, schedule, cost, and quality). More elaborate reports may include:

- Analysis of past performance,
- Analysis of project forecasts (including time and cost),
- Current status of risks and issues,
- Work completed during the period,
- Work to be completed in the next period,
- Summary of changes approved in the period, and
- Other relevant information, which is reviewed and discussed.

10.2.3 Manage Communications: Outputs

10.2.3.1 Project Communications

The Manage Communications process involves the activities that are required for information to be created, distributed, received, acknowledged, and understood. Project communications may include but are not limited to: performance reports, deliverables status, schedule progress, and cost incurred. Project communications can vary significantly and are influenced by factors such as, but not limited to, the urgency and impact of the message, its method of delivery, and level of confidentiality.

10.2.3.2 Project Management Plan Updates

The project management plan provides information on project baselines, communications management, and stakeholder management. Each of these areas may require updates based upon the current performance of the project against the performance measurement baseline (PMB). The performance measurement baseline is an approved plan for the project work to which the project execution is compared, and deviations are measured for management control. The performance measurement baseline typically integrates scope, schedule, and cost parameters of a project, but may also include technical and quality parameters.

10.2.3.3 Project Documents Updates

Project documents that may be updated include, but are not limited to:

- Issue log,
- Project schedule, and
- Project funding requirements.

10.2.3.4 Organizational Process Assets Updates

The organizational process assets, which may be updated include, but are not limited to:

- **Stakeholder notifications.** Information may be provided to stakeholders about resolved issues, approved changes, and general project status.
- **Project reports.** Formal and informal project reports describe project status and include lessons learned, issue logs, project closure reports, and outputs from other Knowledge Areas (Sections 4-13).
- **Project presentations.** The project team provides information formally or informally to any or all of the project stakeholders. The information and presentation method should be relevant to the needs of the audience.
- **Project records.** Project records may include correspondence, memos, meeting minutes, and other documents describing the project. This information should, to the extent possible and appropriate, be maintained in an organized manner. Project team members can also maintain records in a project notebook or register, which could be physical or electronic.

- **Feedback from stakeholders.** Information received from stakeholders concerning project operations is distributed and used to modify or improve future performance of the project.
- **Lessons learned documentation.** Documentation includes the causes of issues, reasoning behind the corrective action chosen, and other types of lessons learned about communications management. Lessons learned need to be documented and distributed so that it becomes part of the historical database for both the project and the performing organization.

10.3 Control Communications

Control Communications is the process of monitoring and controlling communications throughout the entire project life cycle to ensure the information needs of the project stakeholders are met. The key benefit of this process is that it ensures an optimal information flow among all communication participants, at any moment in time. The inputs, tools and techniques, and outputs of this process are depicted in Figure 10-7. Figure 10-8 depicts the data flow diagram of the Control Communications process.

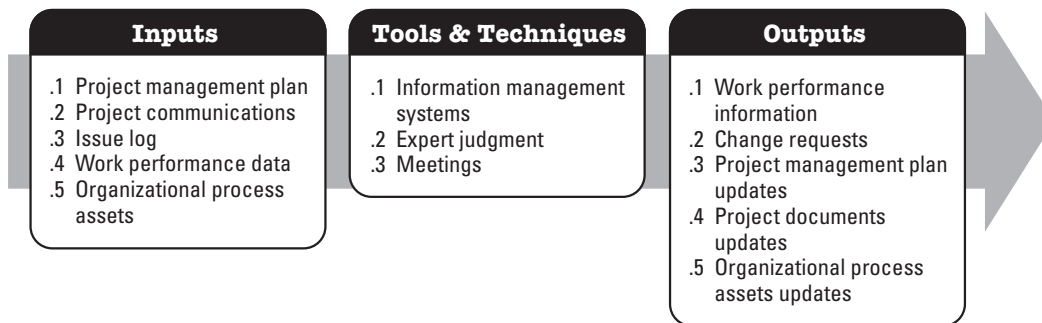

Figure 10-7. Control Communications: Inputs, Tools & Techniques, and Outputs

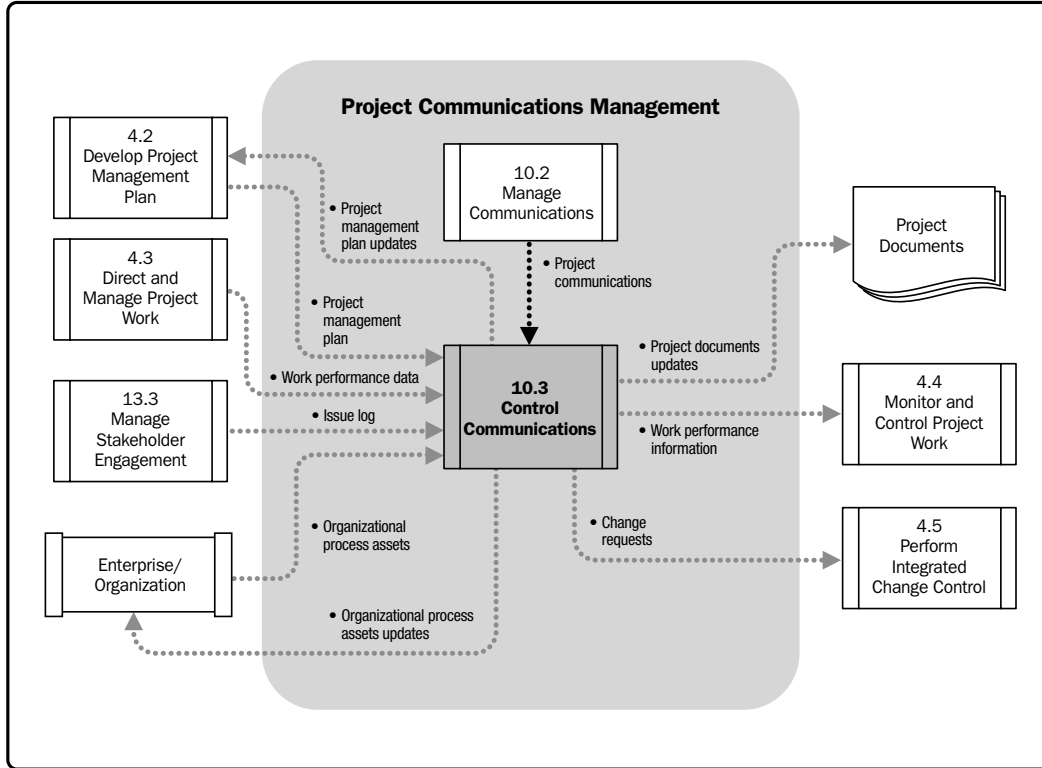

Figure 10-8. Control Communications Data Flow Diagram

The Control Communications process can trigger an iteration of the Plan Communications Management and/or Manage Communications processes. This iteration illustrates the continuous nature of the Project Communications Management processes. Specific communication elements, such as issues or key performance indicators (e.g., actual vs. planned schedule, cost, and quality), may trigger an immediate revision, while others may not. The impact and repercussions of project communications should be carefully evaluated and controlled to ensure that the right message is delivered to the right audience at the right time.

10.3.1 Control Communications: Inputs

10.3.1.1 Project Management Plan

Described in Section 4.2.3.1. The project management plan describes how the project will be executed, monitored, controlled, and closed. It provides valuable information for the Control Communications process such as, but not limited to:

- Stakeholder communication requirements,
- Reason for the distribution of the information,
- Timeframe and frequency for the distribution of required information,
- Individual or group responsible for communication of the information, and
- Individual or group receiving the information.

10.3.1.2 Project Communications

Described in Section 10.2.3.1. The Control Communications process involves the activities that are required for information and communications to be monitored, acted upon, and released to stakeholders. Project communications come from multiple sources and may vary significantly in their format, level of detail, degree of formality and confidentiality. Project communications may include but are not limited to:

- Deliverables status,
- Schedule progress, and
- Costs incurred.

10.3.1.3 Issue Log

Described in Section 13.3.3.1. An issue log is used to document and monitor the resolution of issues. It may be used to facilitate communication and ensure a common understanding of issues. A written log documents and helps to monitor who is responsible for resolving specific issues by a target date. Issue resolution addresses obstacles that can block the team from achieving its goals. This information is important to the Control Communications process as it provides both a repository for what has already happened in the project and a platform for subsequent communications to be delivered.

10.3.1.4 Work Performance Data

Described in Section 4.3.3.2. Work performance data organizes and summarizes the information gathered, and presents the results of comparative analysis to the performance measurement baseline.

10.3.1.5 Organizational Process Assets

Described in Section 2.1.4. The organizational process assets that may influence the Control Communications process include, but are not limited to:

- Report templates;
- Policies, standards, and procedures that define communications;
- Specific communication technologies available;
- Allowed communication media;
- Record retention policies; and
- Security requirements.

10.3.2 Control Communications: Tools and Techniques

10.3.2.1 Information Management Systems

An information management system provides a set of standard tools for the project manager to capture, store, and distribute information to stakeholders about the project's costs, schedule progress, and performance. Some software packages allow the project manager to consolidate reports from several systems and facilitate report distribution to the project stakeholders. Examples of distribution formats may include table reporting, spreadsheet analysis, and presentations. Graphic capabilities can be used to create visual representations of project performance information.

10.3.2.2 Expert Judgment

Expert judgment is often relied upon by the project team to assess the impact of the project communications, need for action or intervention, actions that should be taken, responsibility for taking such actions, and the timeframe for taking action. Expert judgment may need to be applied to technical and/or management details and may be provided by any group or individual with specialized knowledge or training, such as:

- Other units within the organization,
- Consultants,
- Stakeholders, including customers or sponsors,
- Professional and technical associations,
- Industry groups,
- Subject matter experts, and
- Project management office (PMO).

The project manager, in collaboration with the project team, then determines the actions required to ensure that the right message is communicated to the right audience at the right time.

10.3.2.3 Meetings

The Control Communications process requires discussion and dialogue with the project team to determine the most appropriate way to update and communicate project performance, and to respond to requests from stakeholders for information. These discussions and dialogues are commonly facilitated through meetings, which may be conducted face to face or online and in different locations, such as the project site or the client's site. Project meetings also include discussions and dialog with suppliers, vendors, and other project stakeholders.

10

10.3.3 Control Communications: Outputs

10.3.3.1 Work Performance Information

Described in Section 4.4.1.5. Work performance information organizes and summarizes the performance data gathered. This performance data typically provides status and progress information on the project at the level of detail required by the various stakeholders. This information is then communicated to the appropriate stakeholders.

10.3.3.2 Change Requests

Described in Section 4.3.3.3. The Control Communications process often results in the need for adjustment, action, and intervention. As a result, change requests will be generated as an output. These change requests are processed through the Perform Integrated Change Control process (Section 4.5) and may result in:

- New or revised cost estimates, activity sequences, schedule dates, resource requirements, and analysis of risk response alternatives;
- Adjustments to the project management plan and documents;
- Recommendations of corrective actions that may bring the expected future performance of the project back in line with the project management plan; and
- Recommendations of preventive actions that may reduce the probability of incurring future negative project performance.

10.3.3.3 Project Management Plan Updates

Control Communications process may trigger updates to the communications management plan as well as other components of the project management plan (e.g. stakeholders and human resource management plans).

10.3.3.4 Project Documents Updates

Project documents may be updated as a result of the Control Communications process. These updates may include, but are not limited to:

- Forecasts,
- Performance reports, and
- Issue log.

10.3.3.5 Organizational Process Assets Updates

The organizational process assets that may be updated include, but are not limited to, report formats and lessons learned documentation. This documentation may become part of the historical database for both this project and the performing organization and may include the causes of issues, reasons behind the corrective action chosen, and other types of lessons learned during the project.

11

PROJECT RISK MANAGEMENT

Project Risk Management includes the processes of conducting risk management planning, identification, analysis, response planning, and controlling risk on a project. The objectives of project risk management are to increase the likelihood and impact of positive events, and decrease the likelihood and impact of negative events in the project.

Figure 11-1 provides an overview of the Project Risk Management processes, which are as follows:

- 11.1 Plan Risk Management**—The process of defining how to conduct risk management activities for a project.
- 11.2 Identify Risks**—The process of determining which risks may affect the project and documenting their characteristics.
- 11.3 Perform Qualitative Risk Analysis**—The process of prioritizing risks for further analysis or action by assessing and combining their probability of occurrence and impact.
- 11.4 Perform Quantitative Risk Analysis**—The process of numerically analyzing the effect of identified risks on overall project objectives.
- 11.5 Plan Risk Responses**—The process of developing options and actions to enhance opportunities and to reduce threats to project objectives.
- 11.6 Control Risks**—The process of implementing risk response plans, tracking identified risks, monitoring residual risks, identifying new risks, and evaluating risk process effectiveness throughout the project.

These processes interact with each other and with processes in other Knowledge Areas as described in detail in Section 3 and Annex A1.

Project risk is an uncertain event or condition that, if it occurs, has a positive or negative effect on one or more project objectives such as scope, schedule, cost, and quality. A risk may have one or more causes and, if it occurs, it may have one or more impacts. A cause may be a given or potential requirement, assumption, constraint, or condition that creates the possibility of negative or positive outcomes. For example, causes could include the requirement of an environmental permit to do work, or having limited personnel assigned to design the project. The risk is that the permitting agency may take longer than planned to issue a permit; or, in the case of an opportunity, additional development personnel may become available who can participate in design, and they can be assigned to the project. If either of these uncertain events occurs, there may be an impact on the project, scope, cost, schedule, quality, or performance. Risk conditions may include aspects of the project's or organization's environment that contribute to project risk, such as immature project management practices, lack of integrated management systems, concurrent multiple projects, or dependency on external participants who are outside the project's direct control.

Project risk has its origins in the uncertainty present in all projects. Known risks are those that have been identified and analyzed, making it possible to plan responses for those risks. Known risks that cannot be managed proactively, should be assigned a contingency reserve. Unknown risks cannot be managed proactively and therefore may be assigned a management reserve. A negative project risk that has occurred is considered an issue.

Individual project risks are different from overall project risk. Overall project risk represents the effect of uncertainty on the project as a whole. It is more than the sum of the individual risks within a project, since it includes all sources of project uncertainty. It represents the exposure of stakeholders to the implications of variations in project outcome, both positive and negative.

Organizations perceive risk as the effect of uncertainty on projects and organizational objectives. Organizations and stakeholders are willing to accept varying degrees of risk depending on their risk attitude. The risk attitudes of both the organization and the stakeholders may be influenced by a number of factors, which are broadly classified into three themes:

- *Risk appetite*, which is the degree of uncertainty an entity is willing to take on in anticipation of a reward.
- *Risk tolerance*, which is the degree, amount, or volume of risk that an organization or individual will withstand.
- *Risk threshold*, which refers to measures along the level of uncertainty or the level of impact at which a stakeholder may have a specific interest. Below that risk threshold, the organization will accept the risk. Above that risk threshold, the organization will not tolerate the risk.

For example, an organization's risk attitude may include its appetite for uncertainty, its threshold for risk levels that are unacceptable, or its risk tolerance at which point the organization may select a different risk response.

Positive and negative risks are commonly referred to as opportunities and threats. The project may be accepted if the risks are within tolerances and are in balance with the rewards that may be gained by taking the risks. Positive risks that offer opportunities within the limits of risk tolerances may be pursued in order to generate enhanced value. For example, adopting an aggressive resource optimization technique is a risk taken in anticipation of a reward for using fewer resources.

Individuals and groups adopt attitudes toward risk that influence the way they respond. These risk attitudes are driven by perception, tolerances, and other biases, which should be made explicit wherever possible. A consistent approach to risk should be developed for each project, and communication about risk and its handling should be open and honest. Risk responses reflect an organization's perceived balance between risk taking and risk avoidance.

To be successful, an organization should be committed to address risk management proactively and consistently throughout the project. A conscious choice should be made at all levels of the organization to actively identify and pursue effective risk management during the life of the project. Project risk could exist at the moment a project is initiated. Moving forward on a project without a proactive focus on risk management is likely to lead to more problems arising from unmanaged threats.

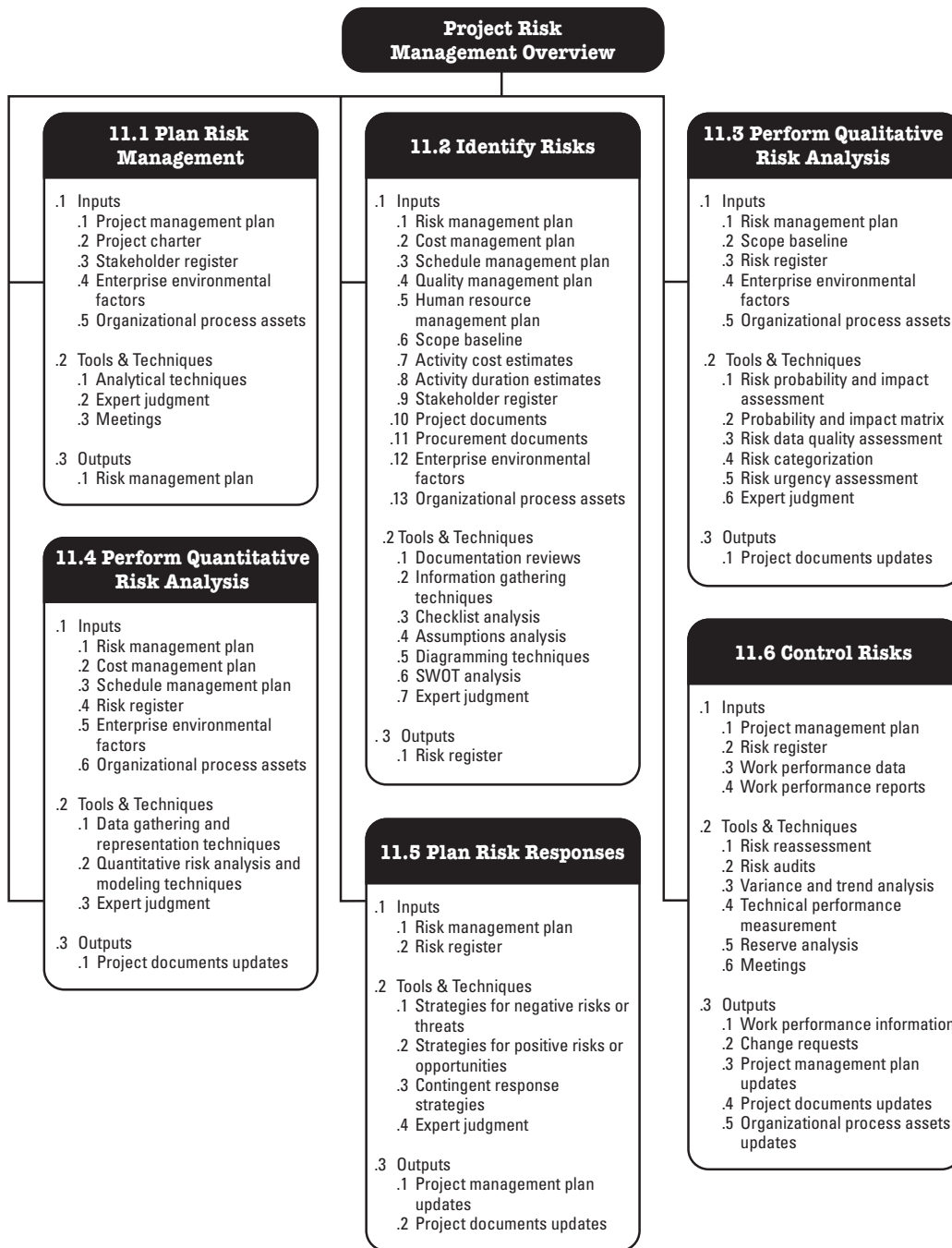

Figure 11-1. Project Risk Management Overview

11.1 Plan Risk Management

Plan Risk Management is the process of defining how to conduct risk management activities for a project. The key benefit of this process is it ensures that the degree, type, and visibility of risk management are commensurate with both the risks and the importance of the project to the organization. The risk management plan is vital to communicate with and obtain agreement and support from all stakeholders to ensure the risk management process is supported and performed effectively over the project life cycle. The inputs, tools and techniques, and outputs of this process are depicted in Figure 11-2. Figure 11-3 depicts the data flow diagram of the process.

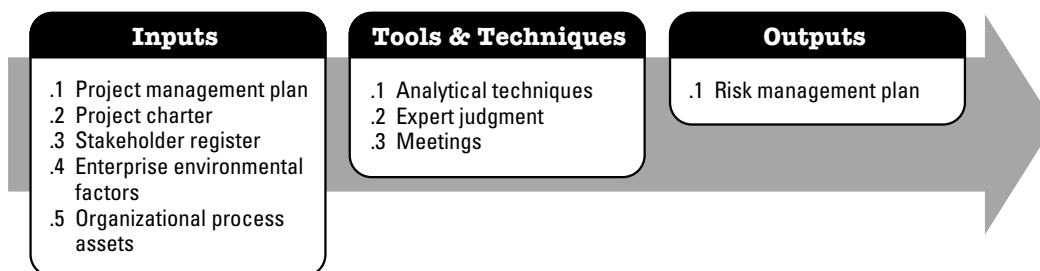

Figure 11-2. Plan Risk Management: Inputs, Tools & Techniques, and Outputs

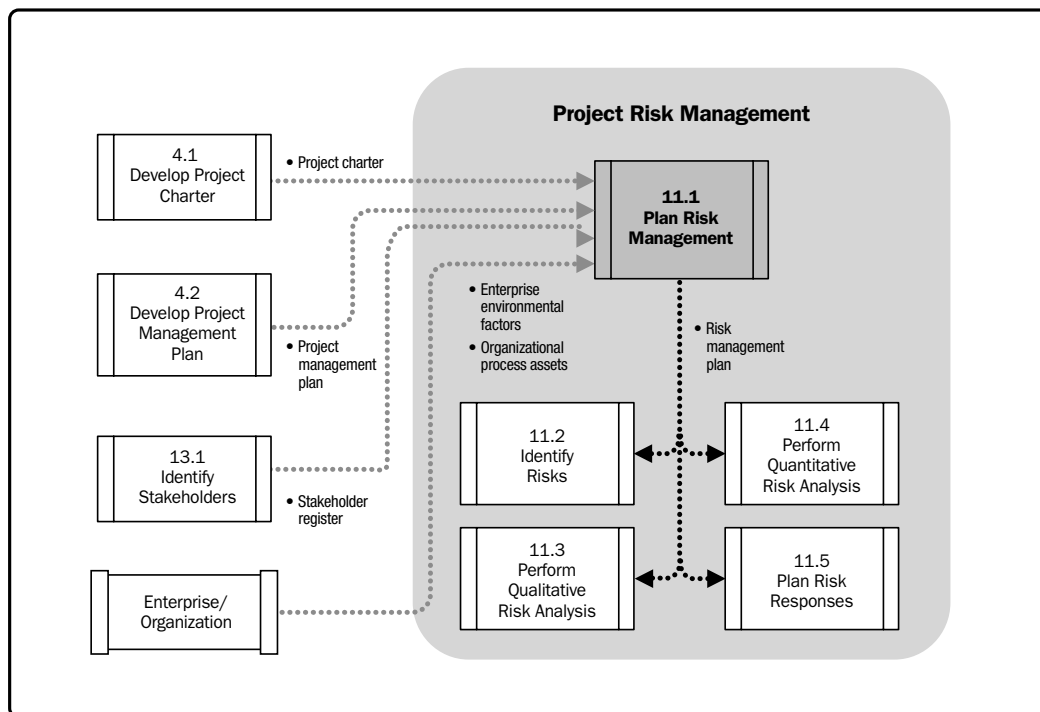

Figure 11-3. Plan Risk Management Data Flow Diagram

Careful and explicit planning enhances the probability of success for other risk management processes. Planning is also important to provide sufficient resources and time for risk management activities and to establish an agreed-upon basis for evaluating risks. The Plan Risk Management process should begin when a project is conceived and should be completed early during project planning.

11.1.1 Plan Risk Management: Inputs

11.1.1.1 Project Management Plan

In planning risk management, all approved subsidiary management plans and baselines should be taken into consideration in order to make the risk management plan consistent with them. The risk management plan is also a component of the project management plan. The project management plan provides baseline or current state of risk-affected areas including scope, schedule, and cost.

11.1.1.2 Project Charter

Described in Section 4.1.3.1. The project charter can provide various inputs such as high-level risks, high-level project descriptions, and high-level requirements.

11.1.1.3 Stakeholder Register

Described in Section 13.1.3.1. The stakeholder register, which contains all details related to the project's stakeholders, provides an overview of their roles.

11.1.1.4 Enterprise Environmental Factors

Described in Section 2.1.5. The enterprise environmental factors that can influence the Plan Risk Management process include, but are not limited to, risk attitudes, thresholds, and tolerances that describe the degree of risk that an organization will withstand.

11.1.1.5 Organizational Process Assets

Described in Section 2.1.4. The organizational process assets that can influence the Plan Risk Management process include, but are not limited to:

- Risk categories,
- Common definitions of concepts and terms,
- Risk statement formats,
- Standard templates,
- Roles and responsibilities,
- Authority levels for decision making, and
- Lessons learned.

11.1.2 Plan Risk Management: Tools and Techniques

11.1.2.1 Analytical Techniques

Analytical techniques are used to understand and define the overall risk management context of the project. Risk management context is a combination of stakeholder risk attitudes and the strategic risk exposure of a given project based on the overall project context. For example, a stakeholder risk profile analysis may be performed to grade and qualify the project stakeholder risk appetite and tolerance. Other techniques, such as the use of strategic risk scoring sheets, are used to provide a high-level assessment of the risk exposure of the project based on the overall project context. Depending on these assessments, the project team can allocate appropriate resources and focus on the risk management activities.

11.1.2.2 Expert Judgment

To ensure a comprehensive establishment of the risk management plan, judgment, and expertise should be considered from groups or individuals with specialized training or knowledge on the subject area, such as:

- Senior management,
- Project stakeholders,
- Project managers who have worked on projects in the same area (directly or through lessons learned),
- Subject matter experts (SMEs) in business or project area,
- Industry groups and consultants, and
- Professional and technical associations.

11.1.2.3 Meetings

Project teams hold planning meetings to develop the risk management plan. Attendees at these meetings may include the project manager, selected project team members and stakeholders, anyone in the organization with responsibility to manage the risk planning and execution activities, and others, as needed.

High-level plans for conducting the risk management activities are defined in these meetings. Risk management cost elements and schedule activities should be developed for inclusion in the project budget and schedule, respectively. Risk contingency reserve application approaches may be established or reviewed. Risk management responsibilities should be assigned. General organizational templates for risk categories and definitions of terms such as levels of risk, probability by type of risk, impact by type of objectives, and the probability and impact matrix will be tailored to the specific project. If templates for other steps in the process do not exist, they may be generated in these meetings. The outputs of these activities are summarized in the risk management plan.

11.1.3 Plan Risk Management: Outputs

11.1.3.1 Risk Management Plan

The risk management plan is a component of the project management plan and describes how risk management activities will be structured and performed. The risk management plan includes the following:

- **Methodology.** Defines the approaches, tools, and data sources that will be used to perform risk management on the project.
- **Roles and responsibilities.** Defines the lead, support, and risk management team members for each type of activity in the risk management plan, and clarifies their responsibilities.
- **Budgeting.** Estimates funds needed, based on assigned resources, for inclusion in the cost baseline and establishes protocols for application of contingency and management reserves.
- **Timing.** Defines when and how often the risk management processes will be performed throughout the project life cycle, establishes protocols for application of schedule contingency reserves, and establishes risk management activities for inclusion in the project schedule.

- Risk categories.** Provide a means for grouping potential causes of risk. Several approaches can be used, for example, a structure based on project objectives by category. A risk breakdown structure (RBS) helps the project team to look at many sources from which project risk may arise in a risk identification exercise. Different RBS structures will be appropriate for different types of projects. An organization can use a previously prepared custom categorization framework, which may take the form of a simple list of categories or may be structured into an RBS. The RBS is a hierarchical representation of risks according to their risk categories. An example is shown in Figure 11-4.

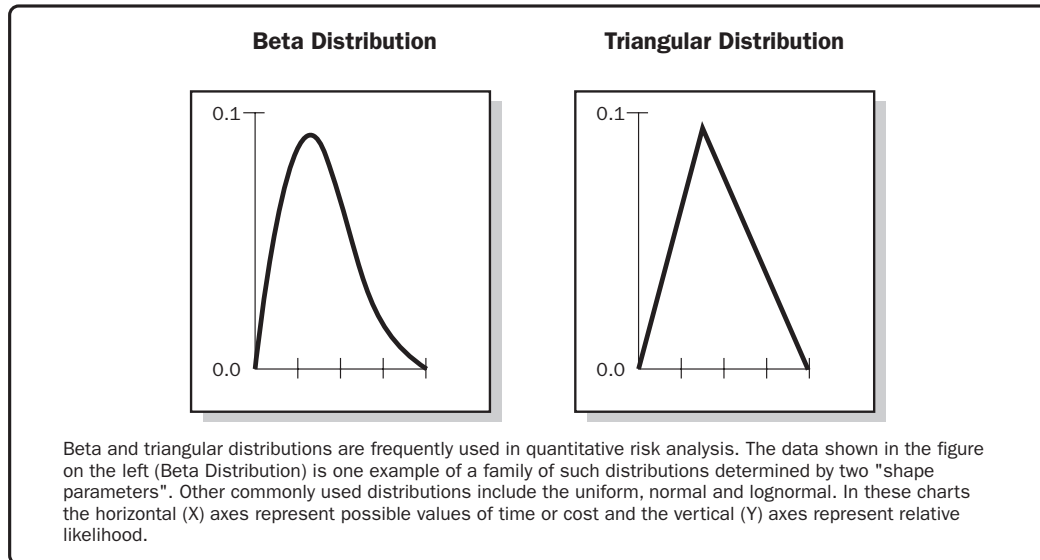

Figure 11-4. Example of a Risk Breakdown Structure (RBS)

- Definitions of risk probability and impact.** The quality and credibility of the risk analysis requires that different levels of risk probability and impact be defined that are specific to the project context. General definitions of probability levels and impact levels are tailored to the individual project during the Plan Risk Management process for use in subsequent processes. Table 11-1 is an example of definitions of negative impacts that could be used in evaluating risk impacts related to four project objectives. (Similar tables may be established with a positive impact perspective). Table 11-1 illustrates both relative and numerical (in this case, nonlinear) approaches.

Table 11-1. Definition of Impact Scales for Four Project Objectives

Defined Conditions for Impact Scales of a Risk on Major Project Objectives (Examples are shown for negative impacts only)					
Project Objective	Relative or numerical scales are shown				
	Very low /0.05	Low /0.10	Moderate /0.20	High /0.40	Very high /0.80
Cost	Insignificant cost increase	< 10% cost increase	10 – 20% cost increase	20 – 40% cost increase	> 40% cost increase
Time	Insignificant time increase	< 5% time increase	5 – 10% time increase	10 – 20% time increase	> 20% time increase
Scope	Scope decrease barely noticeable	Minor areas of scope affected	Major areas of scope affected	Scope reduction unacceptable to sponsor	Project end item is effectively useless
Quality	Quality degradation barely noticeable	Only very demanding applications are affected	Quality reduction requires sponsor approval	Quality reduction unacceptable to sponsor	Project end item is effectively useless

This table presents examples of risk impact definitions for four different project objectives. They should be tailored in the Risk Management Planning process to the individual project and to the organization's risk thresholds. Impact definitions can be developed for opportunities in a similar way.

- **Probability and impact matrix.** A probability and impact matrix is a grid for mapping the probability of each risk occurrence and its impact on project objectives if that risk occurs. Risks are prioritized according to their potential implications for having an effect on the project's objectives. A typical approach to prioritizing risks is to use a look-up table or a probability and impact matrix. The specific combinations of probability and impact that lead to a risk being rated as "high," "moderate," or "low" importance are usually set by the organization.
- **Revised stakeholders' tolerances.** Stakeholders' tolerances, as they apply to the specific project, may be revised in the Plan Risk Management process.
- **Reporting formats.** Reporting formats define how the outcomes of the risk management process will be documented, analyzed, and communicated. It describes the content and format of the risk register as well as any other risk reports required.
- **Tracking.** Tracking documents how risk activities will be recorded for the benefit of the current project and how risk management processes will be audited.

11.2 Identify Risks

Identify Risks is the process of determining which risks may affect the project and documenting their characteristics. The key benefit of this process is the documentation of existing risks and the knowledge and ability it provides to the project team to anticipate events. The inputs, tools and techniques, and outputs of this process are depicted in Figure 11-5. Figure 11-6 depicts the data flow diagram of the process.

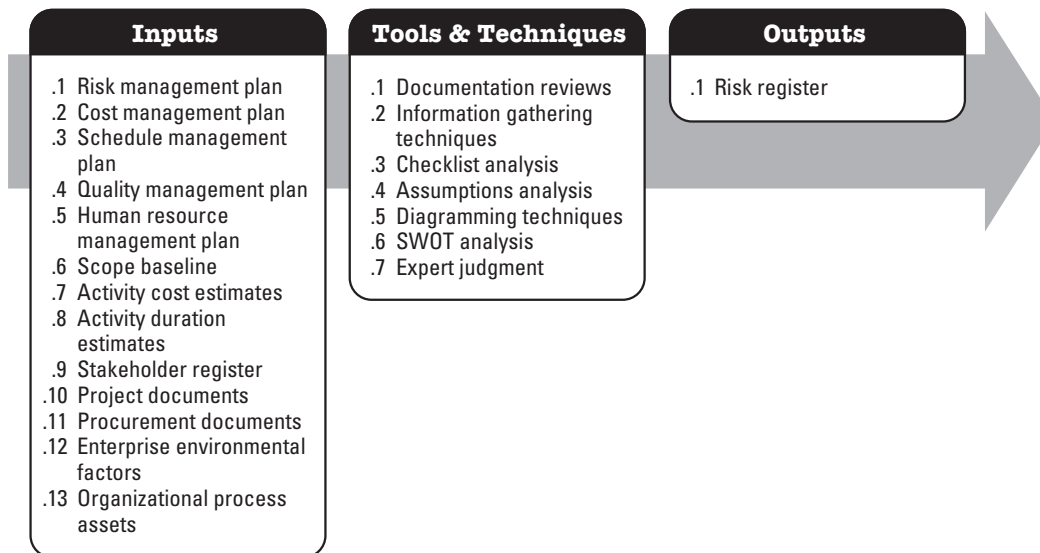

Figure 11-5. Identify Risks: Inputs, Tools & Techniques, and Outputs

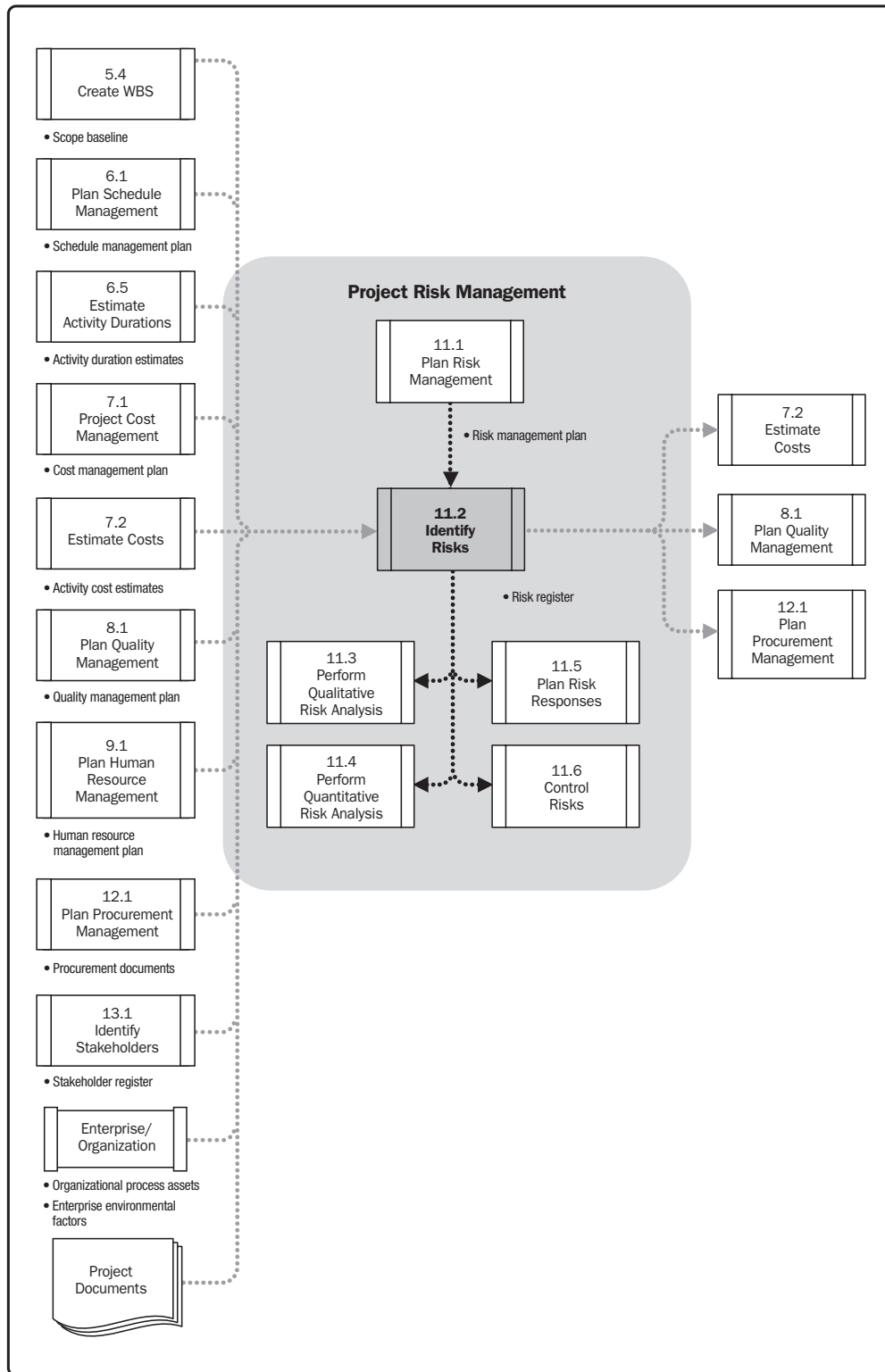

Figure 11-6. Identify Risks Data Flow Diagram

Participants in risk identification activities may include the following: project manager, project team members, risk management team (if assigned), customers, subject matter experts from outside the project team, end users, other project managers, stakeholders, and risk management experts. While these personnel are often key participants for risk identification, all project personnel should be encouraged to identify potential risks.

Identify risks is an iterative process, because new risks may evolve or become known as the project progresses through its life cycle. The frequency of iteration and participation in each cycle will vary by situation. The format of the risk statements should be consistent to ensure that each risk is understood clearly and unambiguously in order to support effective analysis and response development. The risk statement should support the ability to compare the relative effect of one risk against others on the project. The process should involve the project team so they can develop and maintain a sense of ownership and responsibility for the risks and associated risk response actions. Stakeholders outside the project team may provide additional objective information.

11.2.1 Identify Risks: Inputs

11.2.1.1 Risk Management Plan

Described in Section 11.1.3.1. Key elements of the risk management plan that contribute to the Identify Risks process are the assignments of roles and responsibilities, provision for risk management activities in the budget and schedule, and categories of risk, which are sometimes expressed as a risk breakdown structure (Figure 11-4).

11.2.1.2 Cost Management Plan

Described in Section 7.1.3.1. The cost management plan provides processes and controls that can be used to help identify risks across the project.

11.2.1.3 Schedule Management Plan

Described in Section 6.1.3.1. The schedule management plan provides insight to project time/schedule objectives and expectations which may be impacted by risks (known and unknown).

11.2.1.4 Quality Management Plan

Described in Section 8.1.3.1. The quality management plan provides a baseline of quality measures and metrics for use in identifying risks.

11.2.1.5 Human Resource Management Plan

Described in Section 9.1.3.1. The human resource management plan provides guidance on how project human resources should be defined, staffed, managed, and eventually released. It can also contain roles and responsibilities, project organization charts, and the staffing management plan, which form a key input to identify risk process.

11.2.1.6 Scope Baseline

Described in Section 5.4.3.1. Project assumptions are found in the project scope statement. Uncertainty in project assumptions should be evaluated as potential causes of project risk.

The WBS is a critical input to identifying risks as it facilitates an understanding of the potential risks at both the micro and macro levels. Risks can be identified and subsequently tracked at summary, control account, and/or work package levels.

11.2.1.7 Activity Cost Estimates

Described in Section 7.2.3.1. Activity cost estimate reviews are useful in identifying risks as they provide a quantitative assessment of the likely cost to complete scheduled activities and ideally are expressed as a range, with the width of the range indicating the degree(s) of risk. The review may result in projections indicating the estimate is either sufficient or insufficient to complete the activity (i.e., pose a risk to the project).

11.2.1.8 Activity Duration Estimates

Described in Section 6.5.3.1. Activity duration estimate reviews are useful in identifying risks related to the time allowances for the activities or project as a whole, again with the width of the range of such estimates indicating the relative degree(s) of risk.

11.2.1.9 Stakeholder Register

Described in Section 13.1.3.1. Information about the stakeholders is useful for soliciting inputs to identify risks, as this will ensure that key stakeholders, especially the stakeholder, sponsor, and customer are interviewed or otherwise participate during the Identify Risks process.

11.2.1.10 Project Documents

Project documents provide the project team with information about decisions that help better identify project risks. Project documents improve cross-team and stakeholder communications and include, but are not limited to:

- Project charter,
- Project schedule,
- Schedule network diagrams,
- Issue log,
- Quality checklist, and
- Other information proven to be valuable in identifying risks.

11.2.1.11 Procurement Documents

Defined in Section 12.1.3.3. If the project requires external procurement of resources, procurement documents become a key input to the Identify Risks process. The complexity and the level of detail of the procurement documents should be consistent with the value of, and risks associated with, planned procurement.

11

11.2.1.12 Enterprise Environmental Factors

Described in Section 2.1.5. Enterprise environmental factors that can influence the Identify Risks process include, but are not limited to:

- Published information, including commercial databases,
- Academic studies,
- Published checklists,
- Benchmarking,
- Industry studies, and
- Risk attitudes.

11.2.1.13 Organizational Process Assets

Described in Section 2.1.4. Organizational process assets that can influence the Identify Risks process include, but are not limited to:

- Project files, including actual data,
- Organizational and project process controls,
- Risk statement formats or templates, and
- Lessons learned.

11.2.2 Identify Risks: Tools and Techniques

11.2.2.1 Documentation Reviews

A structured review of the project documentation may be performed, including plans, assumptions, previous project files, agreements, and other information. The quality of the plans, as well as consistency between those plans and the project requirements and assumptions, may be indicators of risk in the project.

11.2.2.2 Information Gathering Techniques

Examples of information gathering techniques used in identifying risks can include:

- **Brainstorming.** The goal of brainstorming is to obtain a comprehensive list of project risks. The project team usually performs brainstorming, often with a multidisciplinary set of experts who are not part of the team. Ideas about project risk are generated under the leadership of a facilitator, either in a traditional free-form brainstorm session or structured mass interviewing techniques. Categories of risk, such as in a risk breakdown structure, can be used as a framework. Risks are then identified and categorized by type of risk and their definitions are refined.
- **Delphi technique.** The Delphi technique is a way to reach a consensus of experts. Project risk experts participate in this technique anonymously. A facilitator uses a questionnaire to solicit ideas about the important project risks. The responses are summarized and are then recirculated to the experts for further comment. Consensus may be reached in a few rounds of this process. The Delphi technique helps reduce bias in the data and keeps any one person from having undue influence on the outcome.

- **Interviewing.** Interviewing experienced project participants, stakeholders, and subject matter experts helps to identify risks.
- **Root cause analysis.** Root-cause analysis is a specific technique used to identify a problem, discover the underlying causes that lead to it, and develop preventive action.

11.2.2.3 Checklist Analysis

Risk identification checklists are developed based on historical information and knowledge that has been accumulated from previous similar projects and from other sources of information. The lowest level of the RBS can also be used as a risk checklist. While a checklist may be quick and simple, it is impossible to build an exhaustive one, and care should be taken to ensure the checklist is not used to avoid the effort of proper risk identification. The team should also explore items that do not appear on the checklist. Additionally, the checklist should be pruned from time to time to remove or archive related items. The checklist should be reviewed during project closure to incorporate new lessons learned and improve it for use on future projects.

11.2.2.4 Assumptions Analysis

Every project and its plan is conceived and developed based on a set of hypotheses, scenarios, or assumptions. Assumptions analysis explores the validity of assumptions as they apply to the project. It identifies risks to the project from inaccuracy, instability, inconsistency, or incompleteness of assumptions.

11.2.2.5 Diagramming Techniques

Risk diagramming techniques may include:

- **Cause and effect diagrams.** These are also known as Ishikawa or fishbone diagrams and are useful for identifying causes of risks.
- **System or process flow charts.** These show how various elements of a system interrelate and the mechanism of causation.
- **Influence diagrams.** These are graphical representations of situations showing causal influences, time ordering of events, and other relationships among variables and outcomes, as shown in Figure 11-7.

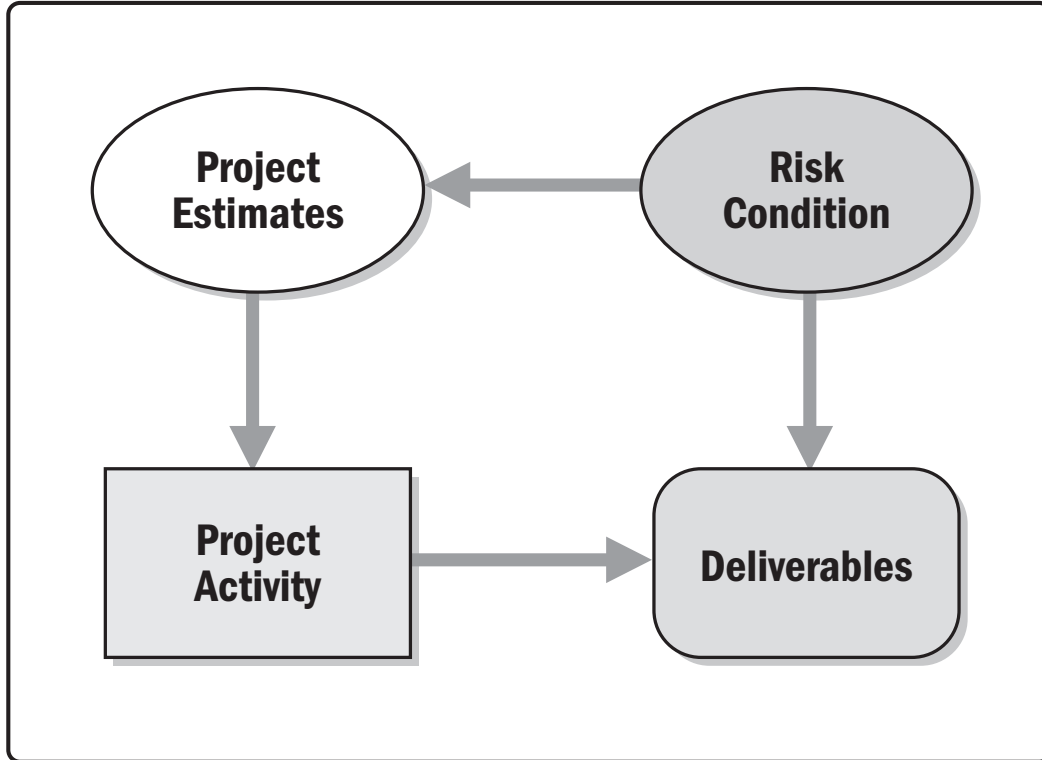

Figure 11-7. Influence Diagram

11.2.2.6 SWOT Analysis

This technique examines the project from each of the strengths, weaknesses, opportunities, and threats (SWOT) perspectives to increase the breadth of identified risks by including internally generated risks. The technique starts with identification of strengths and weaknesses of the organization, focusing on either the project, organization, or the business area in general. SWOT analysis then identifies any opportunities for the project that arise from organizational strengths, and any threats arising from organizational weaknesses. The analysis also examines the degree to which organizational strengths offset threats, as well as identifying opportunities that may serve to overcome weaknesses.

11.2.2.7 Expert Judgment

Risks may be identified directly by experts with relevant experience with similar projects or business areas. Such experts should be identified by the project manager and invited to consider all aspects of the project and suggest possible risks based on their previous experience and areas of expertise. The experts' bias should be taken into account in this process.

11.2.3 Identify Risks: Outputs

11.2.3.1 Risk Register

The primary output from Identify Risks is the initial entry into the risk register. The risk register is a document in which the results of risk analysis and risk response planning are recorded. It contains the outcomes of the other risk management processes as they are conducted, resulting in an increase in the level and type of information contained in the risk register over time. The preparation of the risk register begins in the Identify Risks process with the following information, and then becomes available to other project management and risk management processes:

- **List of identified risks.** The identified risks are described in as much detail as is reasonable. A structure for describing risks using risk statements may be applied, for example, EVENT may occur causing IMPACT, or If CAUSE exists, EVENT may occur leading to EFFECT. In addition to the list of identified risks, the root causes of those risks may become more evident. These are the fundamental conditions or events that may give rise to one or more identified risks. They should be recorded and used to support future risk identification for this and other projects.
- **List of potential responses.** Potential responses to a risk may sometimes be identified during the Identify Risks process. These responses, if identified in this process, should be used as inputs to the Plan Risk Responses process.

11.3 Perform Qualitative Risk Analysis

Perform Qualitative Risk Analysis is the process of prioritizing risks for further analysis or action by assessing and combining their probability of occurrence and impact. The key benefit of this process is that it enables project managers to reduce the level of uncertainty and to focus on high-priority risks. The inputs, tools and techniques, and outputs of this process are depicted in Figure 11-8. Figure 11-9 depicts the data flow diagram of the process.

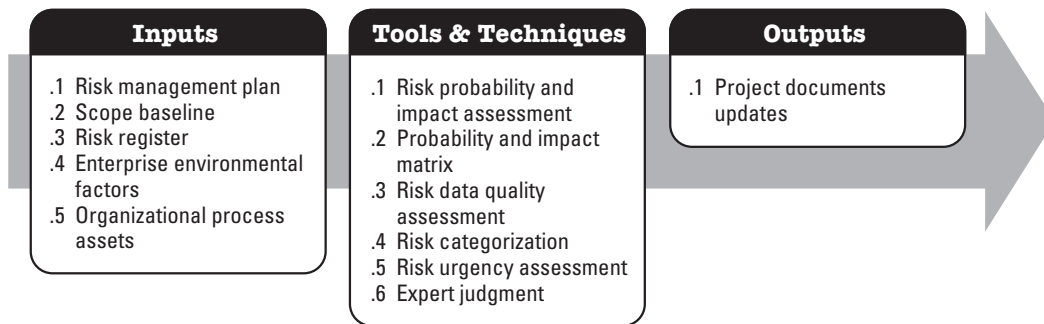

Figure 11-8. Perform Qualitative Risk Analysis: Inputs, Tools & Techniques, and Outputs

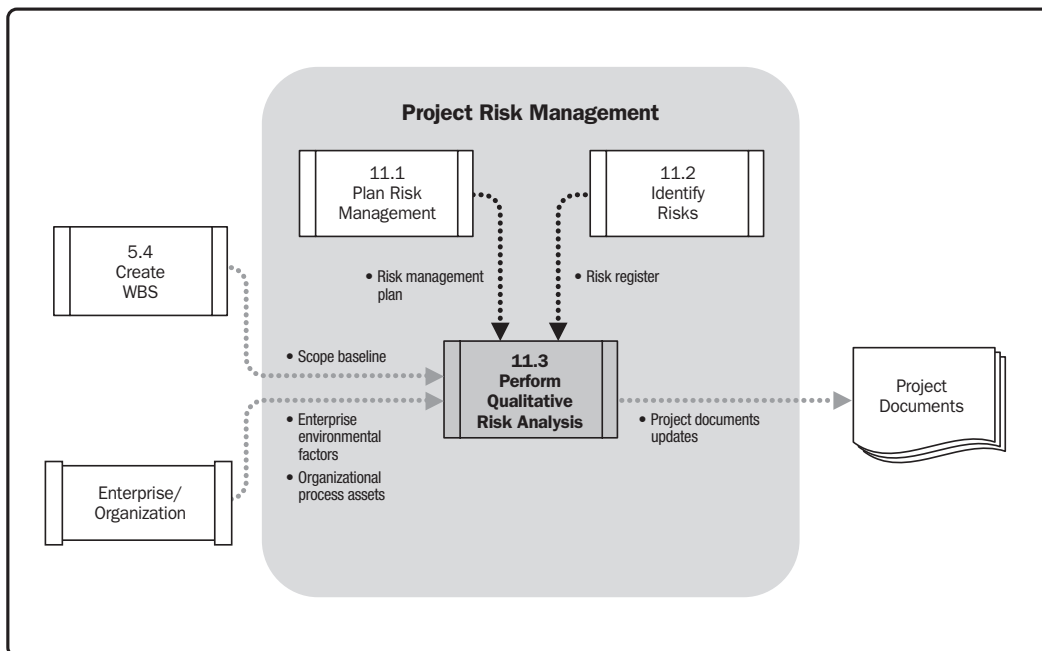

Figure 11-9. Perform Qualitative Risk Analysis Data Flow Diagram

Perform Qualitative Risk Analysis assesses the priority of identified risks using their relative probability or likelihood of occurrence, the corresponding impact on project objectives if the risks occur, as well as other factors such as the time frame for response and the organization's risk tolerance associated with the project constraints of cost, schedule, scope, and quality. Such assessments reflect the risk attitude of the project team and other stakeholders. Effective assessment therefore requires explicit identification and management of the risk approaches of key participants in the Perform Qualitative Risk Analysis process. Where these risk approaches introduce bias into the assessment of identified risks, attention should be paid to identifying bias and correcting for it.

Establishing definitions of the levels of probability and impact can reduce the influence of bias. The time criticality of risk-related actions may magnify the importance of a risk. An evaluation of the quality of the available information on project risks also helps to clarify the assessment of the risk's importance to the project.

Perform Qualitative Risk Analysis is usually a rapid and cost-effective means of establishing priorities for Plan Risk Responses and lays the foundation for Perform Quantitative Risk Analysis, if required. The Perform Qualitative Risk Analysis process is performed regularly throughout the project life cycle, as defined in the project's risk management plan. This process can lead into Perform Quantitative Risk Analysis (Section 11.4) or directly into Plan Risk Responses (Section 11.5).

11.3.1 Perform Qualitative Risk Analysis: Inputs

11.3.1.1 Risk Management Plan

Described in Section 11.1.3.1. Key elements of the risk management plan used in the Perform Qualitative Risk Analysis process include roles and responsibilities for conducting risk management, budgets, schedule activities for risk management, risk categories, definitions of probability and impact, the probability and impact matrix, and revised stakeholders' risk tolerances. These inputs are usually tailored to the project during the Plan Risk Management process. If they are not available, they may be developed during the Perform Qualitative Risk Analysis process.

11.3.1.2 Scope Baseline

Described in Section 5.4.3.1. Projects of a common or recurrent type tend to have more well-understood risks. Projects using state-of-the-art or first-of-its-kind technology, and highly complex projects, tend to have more uncertainty. This can be evaluated by examining the scope baseline.

11.3.1.3 Risk Register

Described in Section 11.2.3.1. The risk register contains the information that will be used to assess and prioritize risks.

11.3.1.4 Enterprise Environmental Factors

Described in Section 2.1.5. Enterprise environmental factors may provide insight and context to the risk assessment, such as:

- Industry studies of similar projects by risk specialists, and
- Risk databases that may be available from industry or proprietary sources.

11.3.1.5 Organizational Process Assets

Described in Section 2.1.4. The organizational process assets that can influence the Perform Qualitative Risk Analysis process include information on prior, similar completed projects.

11.3.2 Perform Qualitative Risk Analysis: Tools and Techniques

11.3.2.1 Risk Probability and Impact Assessment

Risk probability assessment investigates the likelihood that each specific risk will occur. Risk impact assessment investigates the potential effect on a project objective such as schedule, cost, quality, or performance, including both negative effects for threats and positive effects for opportunities.

Probability and impact are assessed for each identified risk. Risks can be assessed in interviews or meetings with participants selected for their familiarity with the risk categories on the agenda. Project team members and knowledgeable persons external to the project are included.

The level of probability for each risk and its impact on each objective is evaluated during the interview or meeting. Explanatory detail, including assumptions justifying the levels assigned, are also recorded. Risk probabilities and impacts are rated according to the definitions given in the risk management plan. Risks with low ratings of probability and impact will be included within the risk register as part of the watch list for future monitoring.

11.3.2.2 Probability and Impact Matrix

Risks can be prioritized for further quantitative analysis and planning risk responses based on their risk rating. Ratings are assigned to risks based on their assessed probability and impact. Evaluation of each risk's importance and priority for attention is typically conducted using a look-up table or a probability and impact matrix. Such a matrix specifies combinations of probability and impact that lead to rating the risks as low, moderate, or high priority. Descriptive terms or numeric values can be used depending on organizational preference.

Each risk is rated on its probability of occurrence and impact on an objective if it does occur. The organization should determine which combinations of probability and impact result in a classification of high risk, moderate risk, and low risk. In a black-and-white matrix, these conditions are denoted using different shades of gray. Specifically in Figure 11-10, the dark gray area (with the largest numbers) represents high risk: the medium gray area (with the smallest numbers) represents low risk, and the light gray area (with in-between numbers) represents moderate risk. Usually, these risk-rating rules are specified by the organization in advance of the project and included in organizational process assets. Risk rating rules can be tailored in the Plan Risk Management process to the specific project.

Probability	Threats					Opportunities				
0.90	0.05	0.09	0.18	0.36	0.72	0.72	0.36	0.18	0.09	0.05
0.70	0.04	0.07	0.14	0.28	0.56	0.56	0.28	0.14	0.07	0.04
0.50	0.03	0.05	0.10	0.20	0.40	0.40	0.20	0.10	0.05	0.03
0.30	0.02	0.03	0.06	0.12	0.24	0.24	0.12	0.06	0.03	0.02
0.10	0.01	0.01	0.02	0.04	0.08	0.08	0.04	0.02	0.01	0.01
	0.05/ Very Low	0.10/ Low	0.20/ Moderate	0.40/ High	0.80/ Very High	0.80/ Very High	0.40/ High	0.20/ Moderate	0.10/ Low	0.05/ Very Low

Impact (numerical scale) on an objective (e.g., cost, time, scope or quality)

Each risk is rated on its probability of occurring and impact on an objective if it does occur. The organization's thresholds for low, moderate or high risks are shown in the matrix and determine whether the risk is scored as high, moderate or low for that objective.

Figure 11-10. Probability and Impact Matrix

As illustrated in Figure 11-10, an organization can rate a risk separately for each objective (e.g., cost, time, and scope). In addition, it may develop ways to determine one overall rating for each risk. Finally, opportunities and threats are handled in the same matrix using definitions of the different levels of impact that are appropriate for each.

The risk score helps guide risk responses. For example, risks that have a negative impact on objectives, otherwise known as threats if they occur, and that are in the high-risk (dark gray) zone of the matrix, may require priority action and aggressive response strategies. Threats found in the low-risk (medium gray) zone may not require proactive management action beyond being placed in the risk register as part of the watch list or adding a contingency reserve. Similarly for opportunities, those in the high-risk (dark gray) zone, which may be obtained most easily and offer the greatest benefit, should be targeted first. Opportunities in the low-risk (medium gray) zone should be monitored.

11.3.2.3 Risk Data Quality Assessment

Risk data quality assessment is a technique to evaluate the degree to which the data about risks is useful for risk management. It involves examining the degree to which the risk is understood and the accuracy, quality, reliability, and integrity of the data about the risk.

The use of low-quality risk data may lead to a qualitative risk analysis of little use to the project. If data quality is unacceptable, it may be necessary to gather better data. Often, the collection of information about risks is difficult, and consumes more time and resources than originally planned. The values used in the example in Figure 11-10 are representative. The numbers of steps in the scale are usually established when defining the risk attitude of the organization.

11.3.2.4 Risk Categorization

Risks to the project can be categorized by sources of risk (e.g., using the RBS), the area of the project affected (e.g., using the WBS), or other useful categories (e.g., project phase) to determine the areas of the project most exposed to the effects of uncertainty. Risks can also be categorized by common root causes. This technique helps determine work packages, activities, project phases or even roles in the project, which can lead to the development of effective risk responses.

11.3.2.5 Risk Urgency Assessment

Risks requiring near-term responses may be considered more urgent to address. Indicators of priority may include probability of detecting the risk, time to affect a risk response, symptoms and warning signs, and the risk rating. In some qualitative analyses, the assessment of risk urgency is combined with the risk ranking that is determined from the probability and impact matrix to give a final risk severity rating.

11.3.2.6 Expert Judgment

Expert judgment is required to assess the probability and impact of each risk to determine its location in the matrix shown in Figure 11-10. Experts generally are those having experience with similar, recent projects. Gathering expert judgment is often accomplished with the use of risk facilitation workshops or interviews. The experts' bias should be taken into account in this process.

11.3.3 Perform Qualitative Risk Analysis: Outputs

11.3.3.1 Project Documents Updates

Project documents that may be updated include, but are not limited to:

- **Risk register updates.** As new information becomes available through the qualitative risk assessment, the risk register is updated. Updates to the risk register may include assessments of probability and impacts for each risk, risk ranking or scores, risk urgency information or risk categorization, and a watch list for low probability risks or risks requiring further analysis.
- **Assumptions log updates.** As new information becomes available through the qualitative risk assessment, assumptions could change. The assumptions log needs to be revisited to accommodate this new information. Assumptions may be incorporated into the project scope statement or in a separate assumptions log.

11.4 Perform Quantitative Risk Analysis

Perform Quantitative Risk Analysis is the process of numerically analyzing the effect of identified risks on overall project objectives. The key benefit of this process is that it produces quantitative risk information to support decision making in order to reduce project uncertainty. The inputs, tools and techniques, and outputs of this process are depicted in Figure 11-11. Figure 11-12 depicts the data flow diagram of the process.

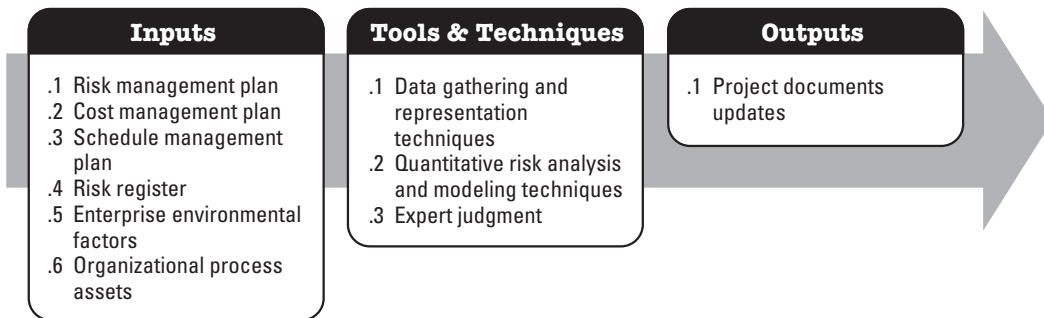

Figure 11-11. Perform Quantitative Risk Analysis: Inputs, Tools & Techniques, and Outputs

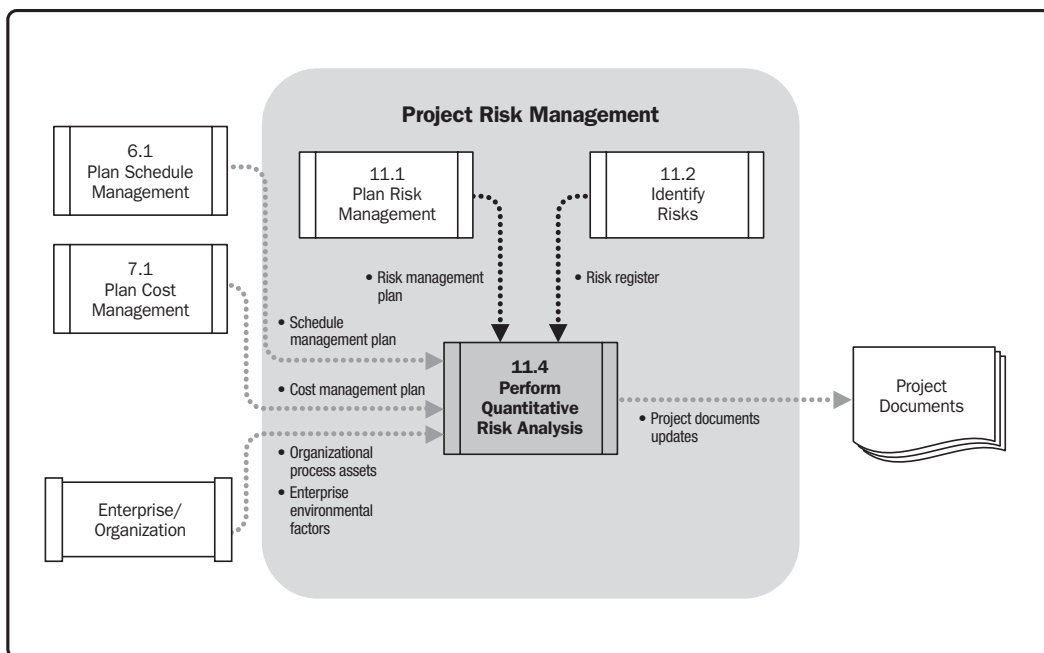

Figure 11-12. Perform Quantitative Risk Analysis Data Flow Diagram

Perform Quantitative Risk Analysis is performed on risks that have been prioritized by the Perform Qualitative Risk Analysis process as potentially and substantially impacting the project’s competing demands. The Perform Quantitative Risk Analysis process analyzes the effect of those risks on project objectives. It is used mostly to evaluate the aggregate effect of all risks affecting the project. When the risks drive the quantitative analysis, the process may be used to assign a numerical priority rating to those risks individually.

Perform Quantitative Risk Analysis generally follows the Perform Qualitative Risk Analysis process. In some cases, it may not be possible to execute the Perform Quantitative Risk Analysis process due to lack of sufficient data to develop appropriate models. The project manager should exercise expert judgment to determine the need for and the viability of quantitative risk analysis. The availability of time and budget, and the need for qualitative or quantitative statements about risk and impacts, will determine which method(s) to use on any particular project. Perform Quantitative Risk Analysis should be repeated, as needed, as part of the Control Risks process to determine if the overall project risk has been satisfactorily decreased. Trends may indicate the need for more or less focus on appropriate risk management activities.

11.4.1 Perform Quantitative Risk Analysis: Inputs

11.4.1.1 Risk Management Plan

Described in Section 11.1.3.1. The risk management plan provides guidelines, methods, and tools to be used in quantitative risk analysis.

11.4.1.2 Cost Management Plan

Described in Section 7.1.3.1. The cost management plan provides guidelines on establishing and managing risk reserves.

11.4.1.3 Schedule Management Plan

Described in Section 6.1.3.1. The schedule management plan provides guidelines on establishing and managing risk reserves.

11.4.1.4 Risk Register

Described in Section 11.2.3.1. The risk register is used as a reference point for performing quantitative risk analysis.

11.4.1.5 Enterprise Environmental Factors

Described in Section 2.1.5. Enterprise environmental factors may provide insight and context to the risk analysis, such as:

- Industry studies of similar projects by risk specialists, and
- Risk databases that may be available from industry or proprietary sources.

11.4.1.6 Organizational Process Assets

Described in Section 2.1.4. The organizational process assets that can influence the Perform Quantitative Risk Analysis process include information from prior, similar completed projects.

11.4.2 Perform Quantitative Risk Analysis: Tools and Techniques

11.4.2.1 Data Gathering and Representation Techniques

- Interviewing.** Interviewing techniques draw on experience and historical data to quantify the probability and impact of risks on project objectives. The information needed depends upon the type of probability distributions that will be used. For instance, information would be gathered on the optimistic (low), pessimistic (high), and most likely scenarios for some commonly used distributions. Examples of three-point estimates for cost are shown in Figure 11-13. Additional information on three-point estimates appears in Estimate Activity Durations (Section 6.5) and Estimate Costs (Section 7.2). Documenting the rationale of the risk ranges and the assumptions behind them are important components of the risk interview because they can provide insight on the reliability and credibility of the analysis.

WBS Element	Low	Most Likely	High
Design	\$4M	\$6M	\$10M
Build	\$16M	\$20M	\$35M
Test	\$11M	\$15M	\$23M
Total Project	\$31M	\$41M	\$68M

Interviewing relevant stakeholders helps determine the three-point estimates for each WBS element for triangular, beta or other distributions. In this example, the likelihood of completing the project at or below the most likely estimate of \$41 million is relatively small as shown in the simulation results in Figure 11-17 (Cost Risk Simulation Results).

Figure 11-13. Range of Project Cost Estimates Collected During the Risk Interview

- Probability distributions.** Continuous probability distributions, which are used extensively in modeling and simulation, represent the uncertainty in values such as durations of schedule activities and costs of project components. Discrete distributions can be used to represent uncertain events, such as the outcome of a test or a possible scenario in a decision tree. Two examples of widely used continuous distributions are shown in Figure 11-14. These distributions depict shapes that are compatible with the data typically developed during the quantitative risk analysis. Uniform distributions can be used if there is no obvious value that is more likely than any other between specified high and low bounds, such as in the early concept stage of design.

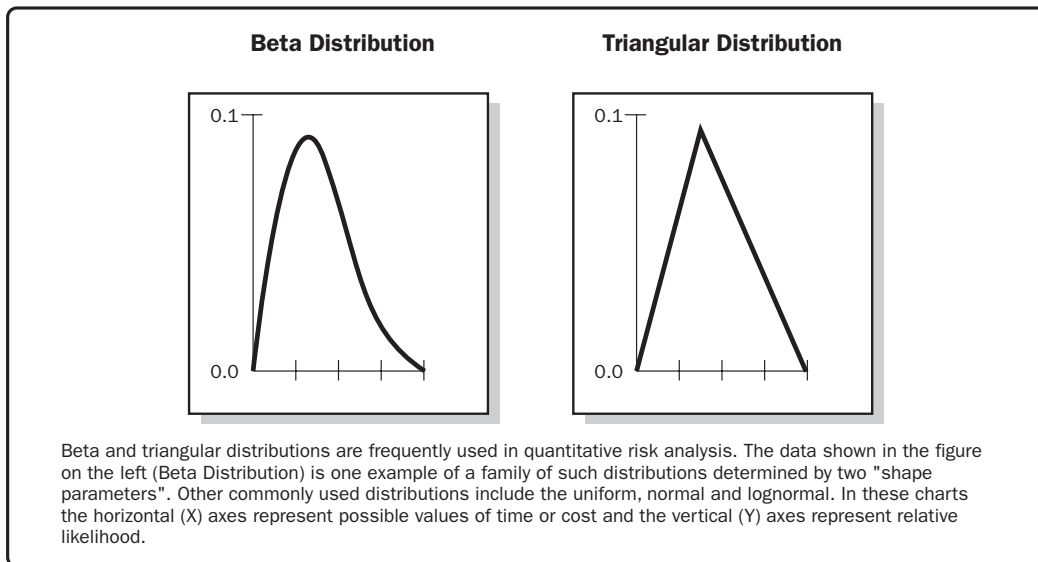

Figure 11-14. Examples of Commonly Used Probability Distributions

11.4.2.2 Quantitative Risk Analysis and Modeling Techniques

Commonly used techniques use both event-oriented and project-oriented analysis approaches, including:

- Sensitivity analysis.** Sensitivity analysis helps to determine which risks have the most potential impact on the project. It helps to understand how the variations in project's objectives correlate with variations in different uncertainties. Conversely, it examines the extent to which the uncertainty of each project element affects the objective being studied when all other uncertain elements are held at their baseline values. One typical display of sensitivity analysis is the tornado diagram (Figure 11-15), which is useful for comparing relative importance and impact of variables that have a high degree of uncertainty to those that are more stable. The Tornado diagram is also helpful in analyzing risk-taking scenarios enabled on specific risks whose quantitative analysis highlights possible benefits greater than corresponding identified negative impacts. A tornado diagram is a special type of bar chart used in sensitivity analysis for comparing the relative importance of the variables. In a tornado diagram, the Y-axis contains each type of uncertainty at base values, and the X-axis contains the spread or correlation of the uncertainty to the studied output. In this figure, each uncertainty contains a horizontal bar and is ordered vertically to show uncertainties with a decreasing spread from the base values.

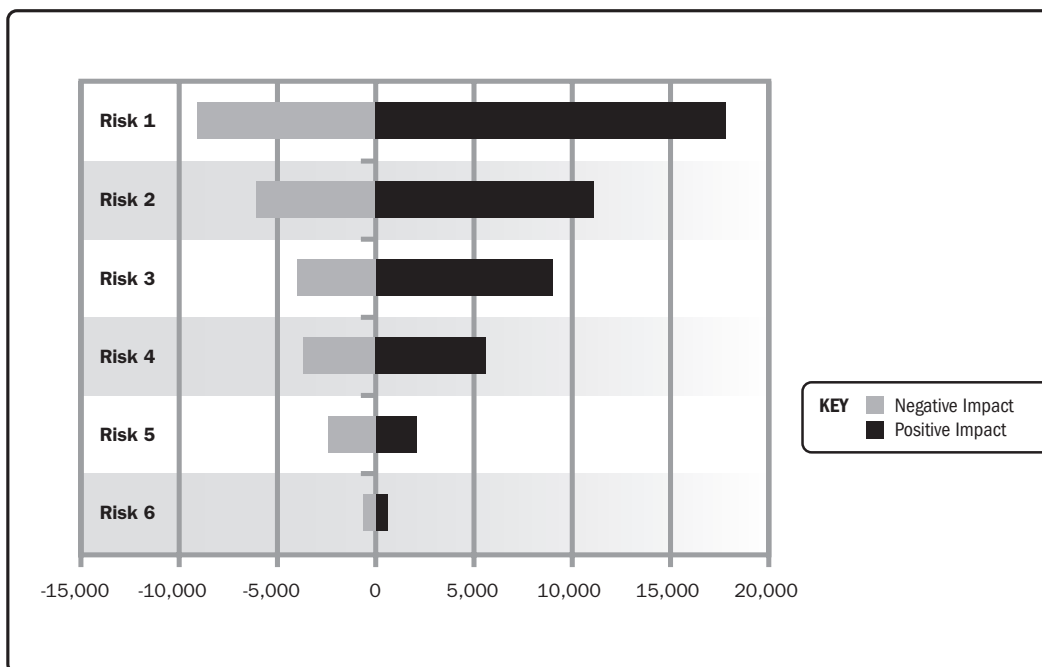

Figure 11-15. Example of Tornado Diagram

- Expected monetary value analysis.** Expected monetary value (EMV) analysis is a statistical concept that calculates the average outcome when the future includes scenarios that may or may not happen (i.e., analysis under uncertainty). The EMV of opportunities are generally expressed as positive values, while those of threats are expressed as negative values. EMV requires a risk-neutral assumption—neither risk averse nor risk seeking. EMV for a project is calculated by multiplying the value of each possible outcome by its probability of occurrence and adding the products together. A common use of this type of analysis is a decision tree analysis (Figure 11-16).

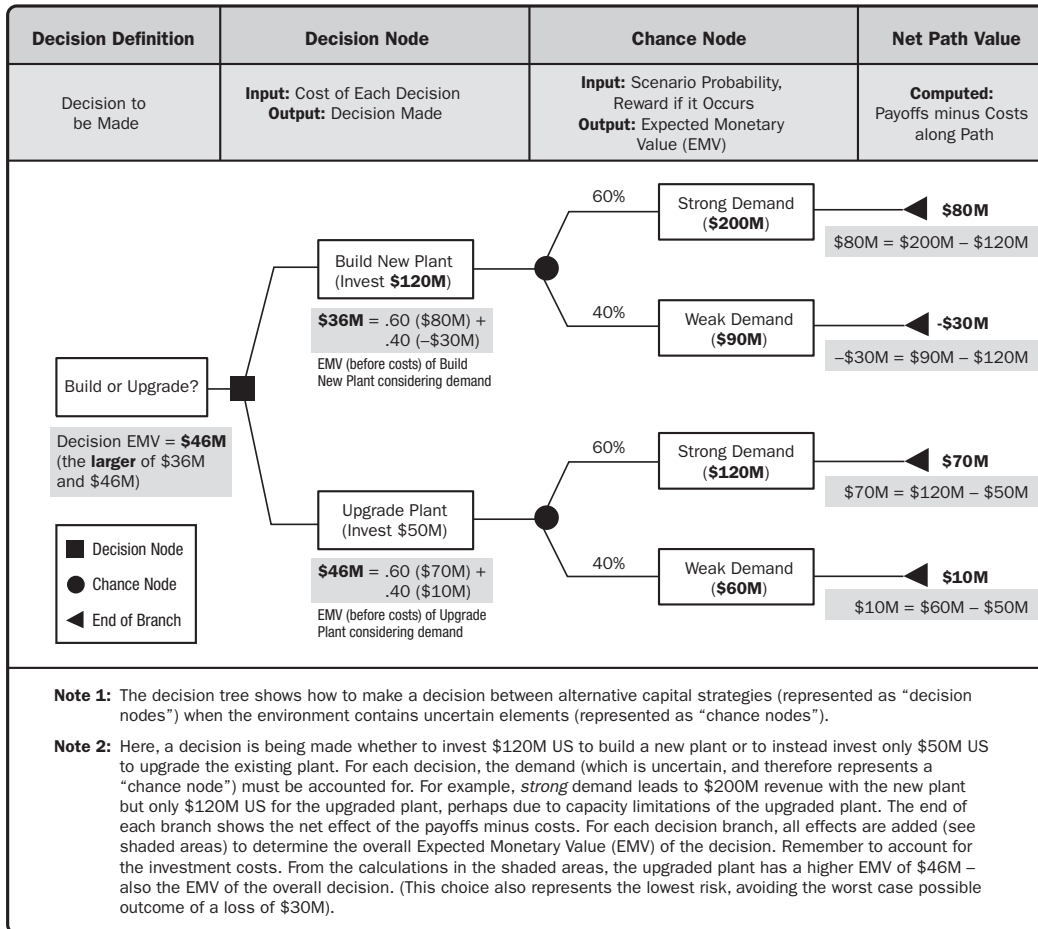

Figure 11-16. Decision Tree Diagram

- Modeling and simulation.** A project simulation uses a model that translates the specified detailed uncertainties of the project into their potential impact on project objectives. Simulations are typically performed using the Monte Carlo technique. In a simulation, the project model is computed many times (iterated), with the input values (e.g., cost estimates or activity durations) chosen at random for each iteration from the probability distributions of these variables. A histogram (e.g., total cost or completion date) is calculated from the iterations. For a cost risk analysis, a simulation uses cost estimates. For a schedule risk analysis, the schedule network diagram and duration estimates are used. The output from a cost risk simulation using the three-element model and risk ranges is shown in Figure 11-17. It illustrates the respective probability of achieving specific cost targets. Similar curves can be developed for other project objectives.

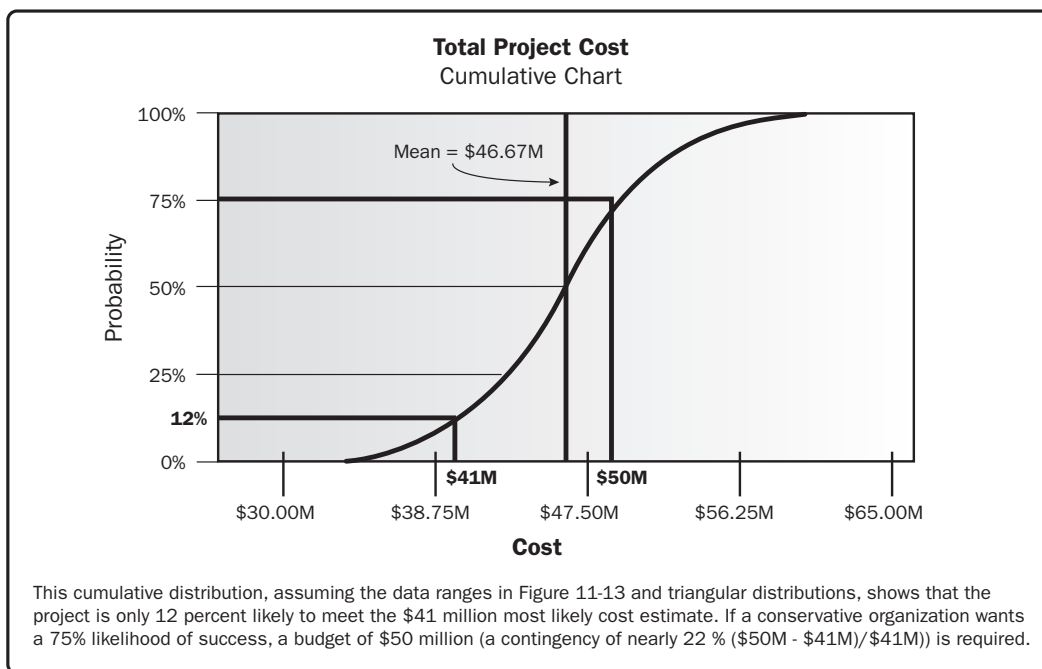

Figure 11-17. Cost Risk Simulation Results

11.4.2.3 Expert Judgment

Expert judgment (ideally using experts with relevant, recent experience) is required to identify potential cost and schedule impacts, to evaluate probability, and to define inputs such as probability distributions into the tools.

Expert judgment also comes into play in the interpretation of the data. Experts should be able to identify the weaknesses of the tools as well as their strengths. Experts may determine when a specific tool may or may not be more appropriate given the organization's capabilities and culture.

11.4.3 Perform Quantitative Risk Analysis: Outputs

11.4.3.1 Project Documents Updates

Project documents are updated with information resulting from quantitative risk analysis. For example, risk register updates could include:

- **Probabilistic analysis of the project.** Estimates are made of potential project schedule and cost outcomes listing the possible completion dates and costs with their associated confidence levels. This output, often expressed as a cumulative frequency distribution, is used with stakeholder risk tolerances to permit quantification of the cost and time contingency reserves. Such contingency reserves are needed to bring the risk of overrunning stated project objectives to a level acceptable to the organization.
- **Probability of achieving cost and time objectives.** With the risks facing the project, the probability of achieving project objectives under the current plan can be estimated using quantitative risk analysis results. For instance, in Figure 11-17, the likelihood of achieving the cost estimate of US\$41 million is about 12%.
- **Prioritized list of quantified risks.** This list includes those risks that pose the greatest threat or present the greatest opportunity to the project. These include the risks that may have the greatest effect on cost contingency and those that are most likely to influence the critical path. These risks may be evaluated, in some cases, through a tornado diagram generated as a result of the simulation analysis.
- **Trends in quantitative risk analysis results.** As the analysis is repeated, a trend may become apparent that leads to conclusions affecting risk responses. Organizational historical information on project schedule, cost, quality, and performance should reflect new insights gained through the Perform Quantitative Risk Analysis process. Such history may take the form of a quantitative risk analysis report. This report may be separate from, or linked to, the risk register.

11.5 Plan Risk Responses

Plan Risk Responses is the process of developing options and actions to enhance opportunities and to reduce threats to project objectives. The key benefit of this process is that it addresses the risks by their priority, inserting resources and activities into the budget, schedule and project management plan as needed. The inputs, tools and techniques, and outputs of this process are depicted in Figure 11-18. Figure 11-19 depicts the data flow diagram of the process.

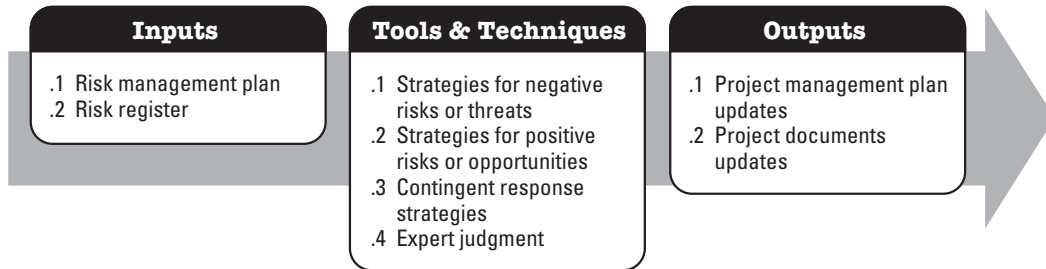

Figure 11-18. Plan Risk Responses: Inputs, Tools & Techniques, and Outputs

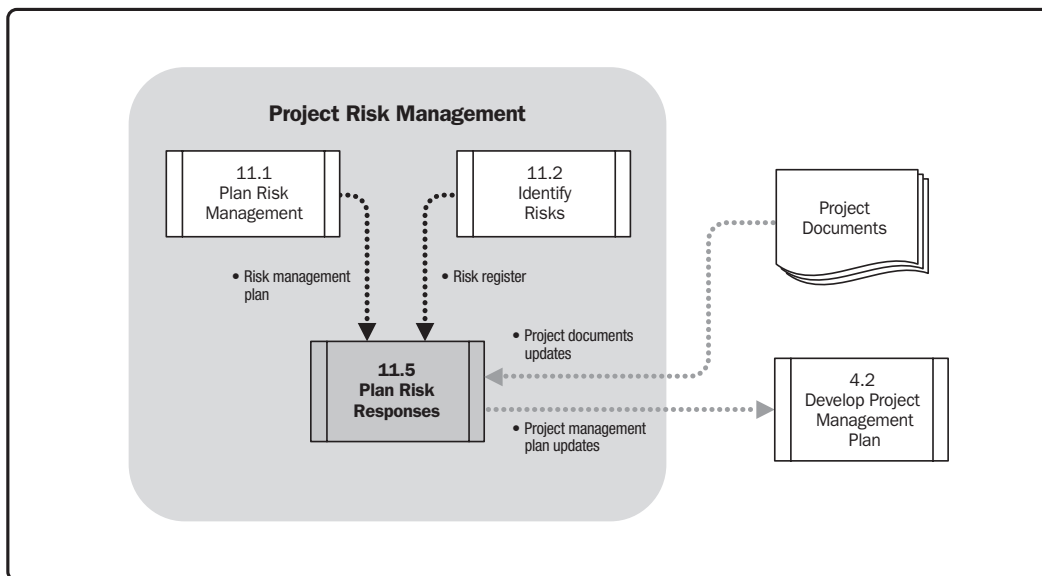

Figure 11-19. Plan Risk Responses Data Flow Diagram

The Plan Risk Responses process follows the Perform Quantitative Risk Analysis process (if used). Each risk response requires an understanding of the mechanism by which it will address the risk. This is the mechanism used to analyze if the risk response plan is having the desired effect. It includes the identification and assignment of one person (an owner for risk response) to take responsibility for each agreed-to and funded risk response. Risk responses should be appropriate for the significance of the risk, cost-effective in meeting the challenge, realistic within the project context, agreed upon by all parties involved, and owned by a responsible person. Selecting the optimum risk response from several options is often required.

The Plan Risk Responses process presents commonly used approaches to planning responses to the risks. Risks include threats and opportunities that can affect project success, and responses are discussed for each.

11.5.1 Plan Risk Responses: Inputs

11.5.1.1 Risk Management Plan

Important components of the risk management plan include roles and responsibilities, risk analysis definitions, timing for reviews (and for eliminating risks from review), and risk thresholds for low, moderate, and high risks. Risk thresholds help identify those risks for which specific responses are needed.

11.5.1.2 Risk Register

The risk register refers to identified risks, root causes of risks, lists of potential responses, risk owners, symptoms and warning signs, the relative rating or priority list of project risks, risks requiring responses in the near term, risks for additional analysis and response, trends in qualitative analysis results, and a watch list, which is a list of low-priority risks within the risk register.

11.5.2 Plan Risk Responses: Tools and Techniques

Several risk response strategies are available. The strategy or mix of strategies most likely to be effective should be selected for each risk. Risk analysis tools, such as decision tree analysis (Section 11.4.2.2), can be used to choose the most appropriate responses. Specific actions are developed to implement that strategy, including primary and backup strategies, as necessary. A fallback plan can be developed for implementation if the selected strategy turns out not to be fully effective or if an accepted risk occurs. Secondary risks should also be reviewed. Secondary risks are risks that arise as a direct result of implementing a risk response. A contingency reserve is often allocated for time or cost. If developed, it may include identification of the conditions that trigger its use.

11.5.2.1 Strategies for Negative Risks or Threats

Three strategies, which typically deal with threats or risks that may have negative impacts on project objectives if they occur, are: *avoid*, *transfer*, and *mitigate*. The fourth strategy, *accept*, can be used for negative risks or threats as well as positive risks or opportunities. Each of these risk response strategies have varied and unique influence on the risk condition. These strategies should be chosen to match the risk's probability and impact on the project's overall objectives. Avoidance and mitigation strategies are usually good strategies for critical risks with high impact, while transference and acceptance are usually good strategies for threats that are less critical and with low overall impact. The four strategies for dealing with negative risks or threats are further described as follows:

- **Avoid.** Risk avoidance is a risk response strategy whereby the project team acts to eliminate the threat or protect the project from its impact. It usually involves changing the project management plan to eliminate the threat entirely. The project manager may also isolate the project objectives from the risk's impact or change the objective that is in jeopardy. Examples of this include extending the schedule, changing the strategy, or reducing scope. The most radical avoidance strategy is to shut down the project entirely. Some risks that arise early in the project can be avoided by clarifying requirements, obtaining information, improving communication, or acquiring expertise.
- **Transfer.** Risk transference is a risk response strategy whereby the project team shifts the impact of a threat to a third party, together with ownership of the response. Transferring the risk simply gives another party responsibility for its management—it does not eliminate it. Transferring does not mean disowning the risk by transferring it to a later project or another person without his or her knowledge or agreement. Risk transference nearly always involves payment of a risk premium to the party taking on the risk. Transferring liability for risk is most effective in dealing with financial risk exposure. Transference tools can be quite diverse and include, but are not limited to, the use of insurance, performance bonds, warranties, guarantees, etc. Contracts or agreements may be used to transfer liability for specified risks to another party. For example, when a buyer has capabilities that the seller does not possess, it may be prudent to transfer some work and its concurrent risk contractually back to the buyer. In many cases, use of a cost-plus contract may transfer the cost risk to the buyer, while a fixed-price contract may transfer risk to the seller.

- **Mitigate.** Risk mitigation is a risk response strategy whereby the project team acts to reduce the probability of occurrence or impact of a risk. It implies a reduction in the probability and/or impact of an adverse risk to be within acceptable threshold limits. Taking early action to reduce the probability and/or impact of a risk occurring on the project is often more effective than trying to repair the damage after the risk has occurred. Adopting less complex processes, conducting more tests, or choosing a more stable supplier are examples of mitigation actions. Mitigation may require prototype development to reduce the risk of scaling up from a bench-scale model of a process or product. Where it is not possible to reduce probability, a mitigation response might address the risk impact by targeting linkages that determine the severity. For example, designing redundancy into a system may reduce the impact from a failure of the original component.
- **Accept.** Risk acceptance is a risk response strategy whereby the project team decides to acknowledge the risk and not take any action unless the risk occurs. This strategy is adopted where it is not possible or cost-effective to address a specific risk in any other way. This strategy indicates that the project team has decided not to change the project management plan to deal with a risk, or is unable to identify any other suitable response strategy. This strategy can be either passive or active. Passive acceptance requires no action except to document the strategy, leaving the project team to deal with the risks as they occur, and to periodically review the threat to ensure that it does not change significantly. The most common active acceptance strategy is to establish a contingency reserve, including amounts of time, money, or resources to handle the risks.

11.5.2.2 Strategies for Positive Risks or Opportunities

Three of the four responses are suggested to deal with risks with potentially positive impacts on project objectives. The fourth strategy, *accept*, can be used for negative risks or threats as well as positive risks or opportunities. These strategies, described below, are to exploit, share, enhance, and accept.

- **Exploit.** The exploit strategy may be selected for risks with positive impacts where the organization wishes to ensure that the opportunity is realized. This strategy seeks to eliminate the uncertainty associated with a particular upside risk by ensuring the opportunity definitely happens. Examples of directly exploiting responses include assigning an organization's most talented resources to the project to reduce the time to completion or using new technologies or technology upgrades to reduce cost and duration required to realize project objectives.

- **Enhance.** The enhance strategy is used to increase the probability and/or the positive impacts of an opportunity. Identifying and maximizing key drivers of these positive-impact risks may increase the probability of their occurrence. Examples of enhancing opportunities include adding more resources to an activity to finish early.
- **Share.** Sharing a positive risk involves allocating some or all of the ownership of the opportunity to a third party who is best able to capture the opportunity for the benefit of the project. Examples of sharing actions include forming risk-sharing partnerships, teams, special-purpose companies, or joint ventures, which can be established with the express purpose of taking advantage of the opportunity so that all parties gain from their actions.
- **Accept.** Accepting an opportunity is being willing to take advantage of the opportunity if it arises, but not actively pursuing it.

11.5.2.3 Contingent Response Strategies

Some responses are designed for use only if certain events occur. For some risks, it is appropriate for the project team to make a response plan that will only be executed under certain predefined conditions, if it is believed that there will be sufficient warning to implement the plan. Events that trigger the contingency response, such as missing intermediate milestones or gaining higher priority with a supplier, should be defined and tracked. Risk responses identified using this technique are often called contingency plans or fallback plans and include identified triggering events that set the plans in effect.

11.5.2.4 Expert Judgment

Expert judgment is input from knowledgeable parties pertaining to the actions to be taken on a specific and defined risk. Expertise may be provided by any group or person with specialized education, knowledge, skill, experience, or training in establishing risk responses.

11.5.3 Plan Risk Responses: Outputs

11.5.3.1 Project Management Plan Updates

Elements of the project management plan that may be updated as a result of carrying out this process include, but are not limited to:

- **Schedule management plan.** The schedule management plan is updated to reflect changes in process and practice driven by the risk responses. This may include changes in tolerance or behavior related to resource loading and leveling, as well as updates to the schedule strategy.
- **Cost management plan.** The cost management plan is updated to reflect changes in process and practice driven by the risk responses. This may include changes in tolerance or behavior related to cost accounting, tracking, and reports, as well as updates to the budget strategy and how contingency reserves are consumed.
- **Quality management plan.** The quality management plan is updated to reflect changes in process and practice driven by the risk responses. This may include changes in tolerance or behavior related to requirements, quality assurance, or quality control, as well as updates to the requirements documentation.
- **Procurement management plan.** The procurement management plan may be updated to reflect changes in strategy, such as alterations in the make-or-buy decision or contract type(s) driven by the risk responses.
- **Human resource management plan.** The staffing management plan, part of the human resource management plan, is updated to reflect changes in project organizational structure and resource applications driven by the risk responses. This may include changes in tolerance or behavior related to staff allocation, as well as updates to the resource loading.
- **Scope baseline.** Because of new, modified or omitted work generated by the risk responses, the scope baseline may be updated to reflect those changes.
- **Schedule baseline.** Because of new work (or omitted work) generated by the risk responses, the schedule baseline may be updated to reflect those changes.
- **Cost baseline.** Because of new work (or omitted work) generated by the risk responses, the cost baseline may be updated to reflect those changes.

11.5.3.2 Project Documents Updates

In the Plan Risk Responses process, several project documents are updated as needed. For example, when appropriate risk responses are chosen and agreed upon, they are included in the risk register. The risk register should be written to a level of detail that corresponds with the priority ranking and the planned response. Often, the high and moderate risks are addressed in detail. Risks judged to be of low priority are included in a watch list for periodic monitoring. Updates to the risk register can include, but are not limited to:

- Risk owners and assigned responsibilities;
- Agreed-upon response strategies;
- Specific actions to implement the chosen response strategy;
- Trigger conditions, symptoms, and warning signs of a risk occurrence;
- Budget and schedule activities required to implement the chosen responses;
- Contingency plans and triggers that call for their execution;
- Fallback plans for use as a reaction to a risk that has occurred and the primary response proves to be inadequate;
- Residual risks that are expected to remain after planned responses have been taken, as well as those that have been deliberately accepted;
- Secondary risks that arise as a direct outcome of implementing a risk response; and
- Contingency reserves that are calculated based on the quantitative risk analysis of the project and the organization's risk thresholds.

Other project documents updated could include:

- **Assumptions log updates.** As new information becomes available through the application of risk responses, assumptions could change. The assumptions log needs to be revisited to accommodate this new information.
- **Technical documentation updates.** As new information becomes available through the application of risk responses, technical approaches and physical deliverables may change. Any supporting documentation needs to be revisited to accommodate this new information.
- **Change requests.** Planning for possible risk responses can often result in recommendations for changes to the resources, activities, cost estimates, and other items identified during other planning processes. When such recommendations are identified, change requests are generated and processed through the Perform Integrated Change Control process.

11.6 Control Risks

Control Risks is the process of implementing risk response plans, tracking identified risks, monitoring residual risks, identifying new risks, and evaluating risk process effectiveness throughout the project. The key benefit of this process is that it improves efficiency of the risk approach throughout the project life cycle to continuously optimize risk responses. The inputs, tools and techniques, and outputs of this process are depicted in Figure 11-20. Figure 11-21 depicts the data flow diagram of the process.

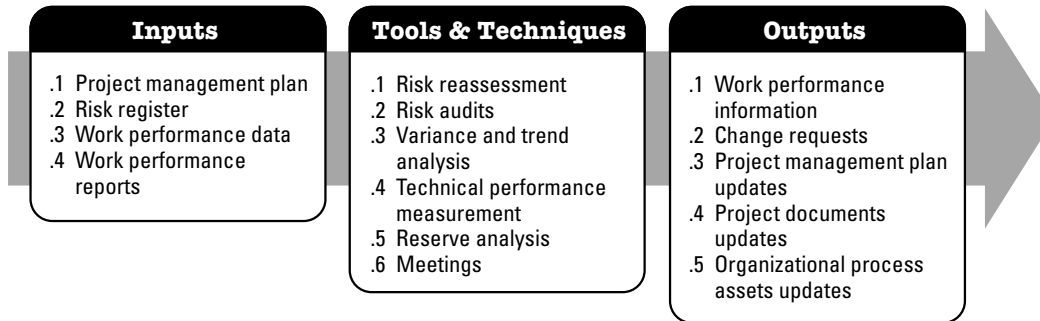

Figure 11-20. Control Risks: Inputs, Tools & Techniques, and Outputs

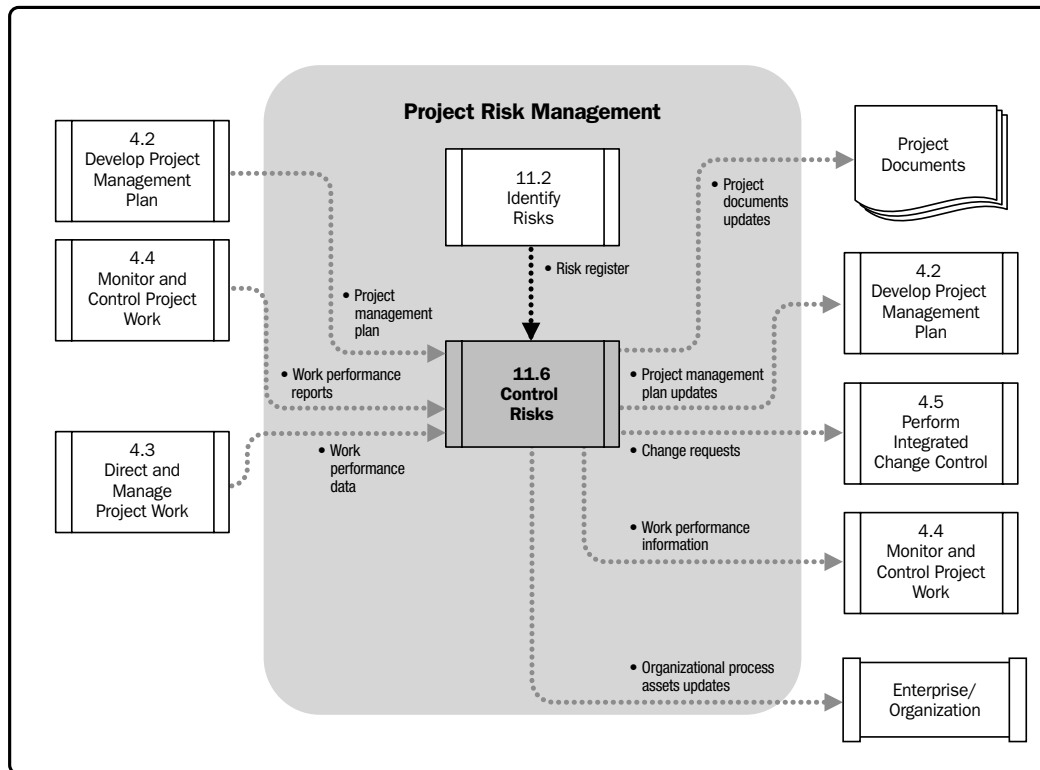

Figure 11-21. Control Risks Data Flow Diagram

Planned risk responses that are included in the risk register are executed during the life cycle of the project, but the project work should be continuously monitored for new, changing, and outdated risks.

The Control Risks process applies techniques, such as variance and trend analysis, which require the use of performance information generated during project execution. Other purposes of the Control Risks process are to determine if:

- Project assumptions are still valid,
- Analysis shows an assessed risk has changed or can be retired,
- Risk management policies and procedures are being followed, and
- Contingency reserves for cost or schedule should be modified in alignment with the current risk assessment.

Control Risks can involve choosing alternative strategies, executing a contingency or fallback plan, taking corrective action, and modifying the project management plan. The risk response owner reports periodically to the project manager on the effectiveness of the plan, any unanticipated effects, and any correction needed to handle the risk appropriately. Control Risks also includes updating the organizational process assets, including project lessons learned databases and risk management templates, for the benefit of future projects.

11.6.1 Control Risks: Inputs

11.6.1.1 Project Management Plan

Described in Section 4.2.3.1. The project management plan, which includes the risk management plan, provides guidance for risk monitoring and controlling.

11.6.1.2 Risk Register

The risk register has key inputs that include identified risks and risk owners, agreed-upon risk responses, control actions for assessing the effectiveness of response plans, risk responses, specific implementation actions, symptoms and warning signs of risk, residual and secondary risks, a watch list of low-priority risks, and the time and cost contingency reserves. The watch list is within the risk register and provides a list of low-priority risks.

11.6.1.3 Work Performance Data

Described in Section 4.3.3.2. Work performance data related to various performance results possibly impacted by risks includes, but is not limited to:

- Deliverable status,
- Schedule progress, and
- Costs incurred.

11.6.1.4 Work Performance Reports

Described in Section 4.4.3.2. Work performance reports take information from performance measurements and analyze it to provide project work performance information including variance analysis, earned value data, and forecasting data. These data points could be impactful in controlling performance related risks.

11.6.2 Control Risks: Tools and Techniques

11.6.2.1 Risk Reassessment

Control Risks often results in identification of new risks, reassessment of current risks, and the closing of risks that are outdated. Project risk reassessments should be regularly scheduled. The amount and detail of repetition that are appropriate depends on how the project progresses relative to its objectives.

11.6.2.2 Risk Audits

Risk audits examine and document the effectiveness of risk responses in dealing with identified risks and their root causes, as well as the effectiveness of the risk management process. The project manager is responsible for ensuring that risk audits are performed at an appropriate frequency, as defined in the project's risk management plan. Risk audits may be included during routine project review meetings, or the team may choose to hold separate risk audit meetings. The format for the audit and its objectives should be clearly defined before the audit is conducted.

11.6.2.3 Variance and Trend Analysis

Many control processes employ variance analysis to compare the planned results to the actual results. For the purposes of controlling risks, trends in the project's execution should be reviewed using performance information. Earned value analysis and other methods of project variance and trend analysis may be used for monitoring overall project performance. Outcomes from these analyses may forecast potential deviation of the project at completion from cost and schedule targets. Deviation from the baseline plan may indicate the potential impact of threats or opportunities.

11.6.2.4 Technical Performance Measurement

Technical performance measurement compares technical accomplishments during project execution to the schedule of technical achievement. It requires the definition of objective, quantifiable measures of technical performance, which can be used to compare actual results against targets. Such technical performance measures may include weight, transaction times, number of delivered defects, storage capacity, etc. Deviation, such as demonstrating more or less functionality than planned at a milestone, can help to forecast the degree of success in achieving the project's scope.

11.6.2.5 Reserve Analysis

Throughout execution of the project, some risks may occur with positive or negative impacts on budget or schedule contingency reserves. Reserve analysis compares the amount of the contingency reserves remaining to the amount of risk remaining at any time in the project in order to determine if the remaining reserve is adequate.

11.6.2.6 Meetings

Project risk management should be an agenda item at periodic status meetings. The amount of time required for that item will vary, depending upon the risks that have been identified, their priority, and difficulty of response. The more often risk management is practiced, the easier it becomes. Frequent discussions about risk make it more likely that people will identify risks and opportunities.

11.6.3 Control Risks: Outputs

11.6.3.1 Work Performance Information

Work performance information, as a Control Risks output, provides a mechanism to communicate and support project decision making.

11.6.3.2 Change Requests

Implementing contingency plans or workarounds sometimes results in a change request. Change requests are prepared and submitted to the Perform Integrated Change Control process (Section 4.5). Change requests can include recommended corrective and preventive actions as well.

- **Recommended corrective actions.** These are activities that realign the performance of the project work with the project management plan. They include contingency plans and workarounds. The latter are responses that were not initially planned, but are required to deal with emerging risks that were previously unidentified or accepted passively.
- **Recommended preventive actions.** These are activities that ensure that future performance of the project work is aligned with the project management plan.

11.6.3.3 Project Management Plan Updates

If the approved change requests have an effect on the risk management processes, the corresponding component documents of the project management plan are revised and reissued to reflect the approved changes. The elements of the project management plan that may be updated are the same as those in the Plan Risk Responses process.

11.6.3.4 Project Documents Updates

Project documents that may be updated as a result of the Control Risk process include, but are not limited to the risk register. Risk register updates may include:

- **Outcomes of risk reassessments, risk audits, and periodic risk reviews.** These outcomes may include identification of new risks, updates to probability, impact, priority, response plans, ownership, and other elements of the risk register. Outcomes can also include closing risks that are no longer applicable and releasing their associated reserves.
- **Actual outcomes of the project's risks and of the risk responses.** This information can help project managers to plan for risk throughout their organizations, as well as on future projects.

11.6.3.5 Organizational Process Assets Updates

The risk management processes produce information that may be used for future projects, and should be captured in the organizational process assets. The organizational process assets that may be updated include, but are not limited to:

- Templates for the risk management plan, including the probability and impact matrix and risk register,
- Risk breakdown structure, and
- Lessons learned from the project risk management activities.

These documents should be updated as needed and at project closure. Final versions of the risk register and the risk management plan templates, checklists, and risk breakdown structure are included.

12

PROJECT PROCUREMENT MANAGEMENT

Project Procurement Management includes the processes necessary to purchase or acquire products, services, or results needed from outside the project team. The organization can be either the buyer or seller of the products, services, or results of a project.

Project Procurement Management includes the contract management and change control processes required to develop and administer contracts or purchase orders issued by authorized project team members.

Project Procurement Management also includes controlling any contract issued by an outside organization (the buyer) that is acquiring deliverables from the project from the performing organization (the seller), and administering contractual obligations placed on the project team by the contract.

Figure 12-1 provides an overview of the Project Procurement Management processes which include the following:

12.1 Plan Procurement Management—The process of documenting project procurement decisions, specifying the approach, and identifying potential sellers.

12.2 Conduct Procurements—The process of obtaining seller responses, selecting a seller, and awarding a contract.

12.3 Control Procurements—The process of managing procurement relationships, monitoring contract performance, and making changes and corrections as appropriate.

12.4 Close Procurements—The process of completing each project procurement.

These processes interact with each other and with processes in other Knowledge Areas as described in detail in Section 3 and Annex A1.

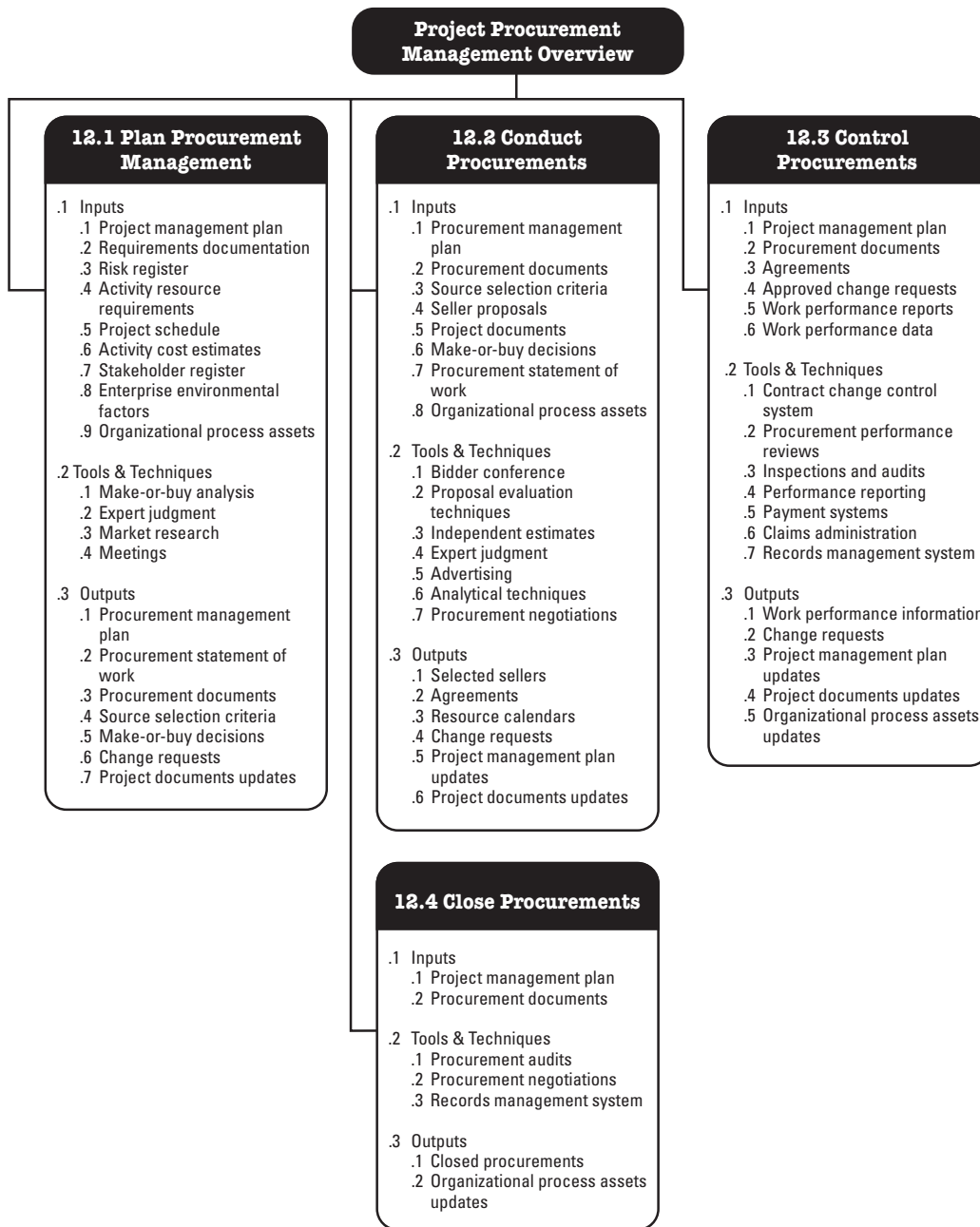

Figure 12-1. Project Procurement Management Overview

The Project Procurement Management processes involve agreements, including contracts, which are legal documents between a buyer and a seller. A contract represents a mutually binding agreement that obligates the seller to provide something of value (e.g., specified products, services, or results) and obligates the buyer to provide monetary or other valuable compensation. An agreement can be simple or complex, and may reflect the simplicity or complexity of the deliverables or required effort.

A procurement contract includes terms and conditions, and may incorporate other items that the buyer specifies as to what the seller is to perform or provide. It is the project management team's responsibility to make certain that all procurements meet the specific needs of the project while adhering to organizational procurement policies. Depending upon the application area, a contract can also be called an agreement, an understanding, a subcontract, or a purchase order. Most organizations document policies and procedures specifically defining the procurement rules and specifying who has authority to sign and administer such agreements on behalf of the organization.

Although all project documents may be subject to some form of review and approval, the legally binding nature of a contract or agreement usually means it will be subjected to a more extensive approval process. In all cases, the primary focus of the review and approval process is to ensure that the contract language describes the products, services, or results that will satisfy the identified project need.

The project management team may seek support in early phases from specialists in contracting, purchasing, law, and technical disciplines. Such involvement can be mandated by an organization's policies.

The various activities involved in the Project Procurement Management processes form the life cycle of an agreement. By actively managing the agreement life cycle and carefully wording the terms and conditions of a procurement, some identifiable project risks may be shared or transferred to a seller. Entering into an agreement for products or services is one method of allocating the responsibility for managing or sharing potential risks.

A complex project may involve managing multiple contracts or subcontracts simultaneously or in sequence. In such cases, each contract life cycle may end during any phase of the project life cycle. Project Procurement Management is discussed within the perspective of the buyer-seller relationship. The buyer-seller relationship may exist at many levels on any one project, and between organizations internal to and external to the acquiring organization.

Depending on the application area, the seller may be identified as a contractor, subcontractor, vendor, service provider, or supplier. Depending on the buyer's position in the project acquisition cycle, the buyer may be called a client, customer, prime contractor, contractor, acquiring organization, service requestor, or purchaser. The seller can be viewed during the contract life cycle first as a bidder, then as the selected source, and then as the contracted supplier or vendor.

The seller will typically manage the work as a project if the acquisition is not just for shelf material, goods, or common products. In such cases:

- The buyer becomes the customer, and is thus a key project stakeholder for the seller.
- The seller's project management team is concerned with all the processes of project management, not only with those of this Knowledge Area.
- Terms and conditions of the contract become key inputs to many of the seller's management processes. The contract can actually contain the inputs (e.g., major deliverables, key milestones, cost objectives), or it can limit the project team's options (e.g., buyer approval of staffing decisions is often required on design projects).

In this section, it is assumed that the buyer of an item for the project is assigned to the project team and that the seller is organizationally external to the project team. It is also assumed that a formal contractual relationship will be developed and exists between the buyer and the seller. However, most of the discussion in this section is equally applicable to non-contractual work entered into with other units of the project team's organization.

12.1 Plan Procurement Management

Plan Procurement Management is the process of documenting project procurement decisions, specifying the approach, and identifying potential sellers. The key benefit of this process is that it determines whether to acquire outside support, and if so, what to acquire, how to acquire it, how much is needed, and when to acquire it. The inputs, tools and techniques, and outputs of this process are depicted in Figure 12-2. Figure 12-3 depicts the data flow diagram of the process.

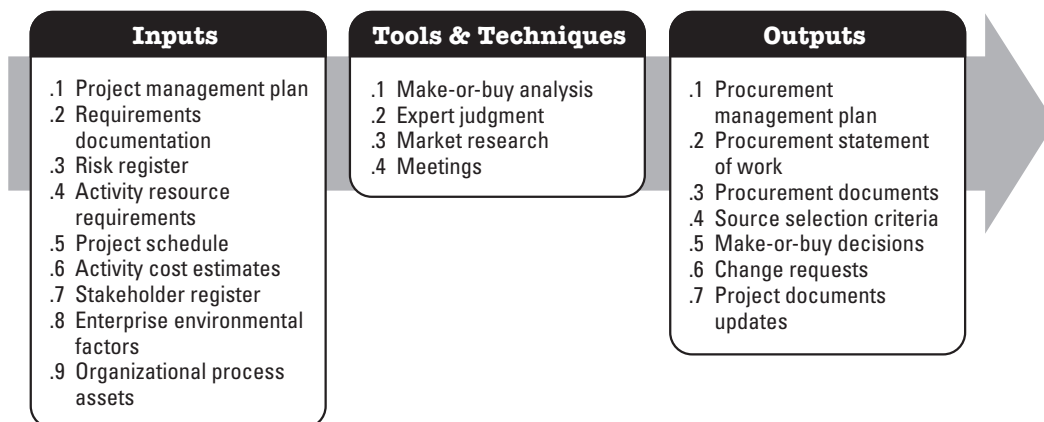

Figure 12-2. Plan Procurements: Inputs, Tools & Techniques, and Outputs

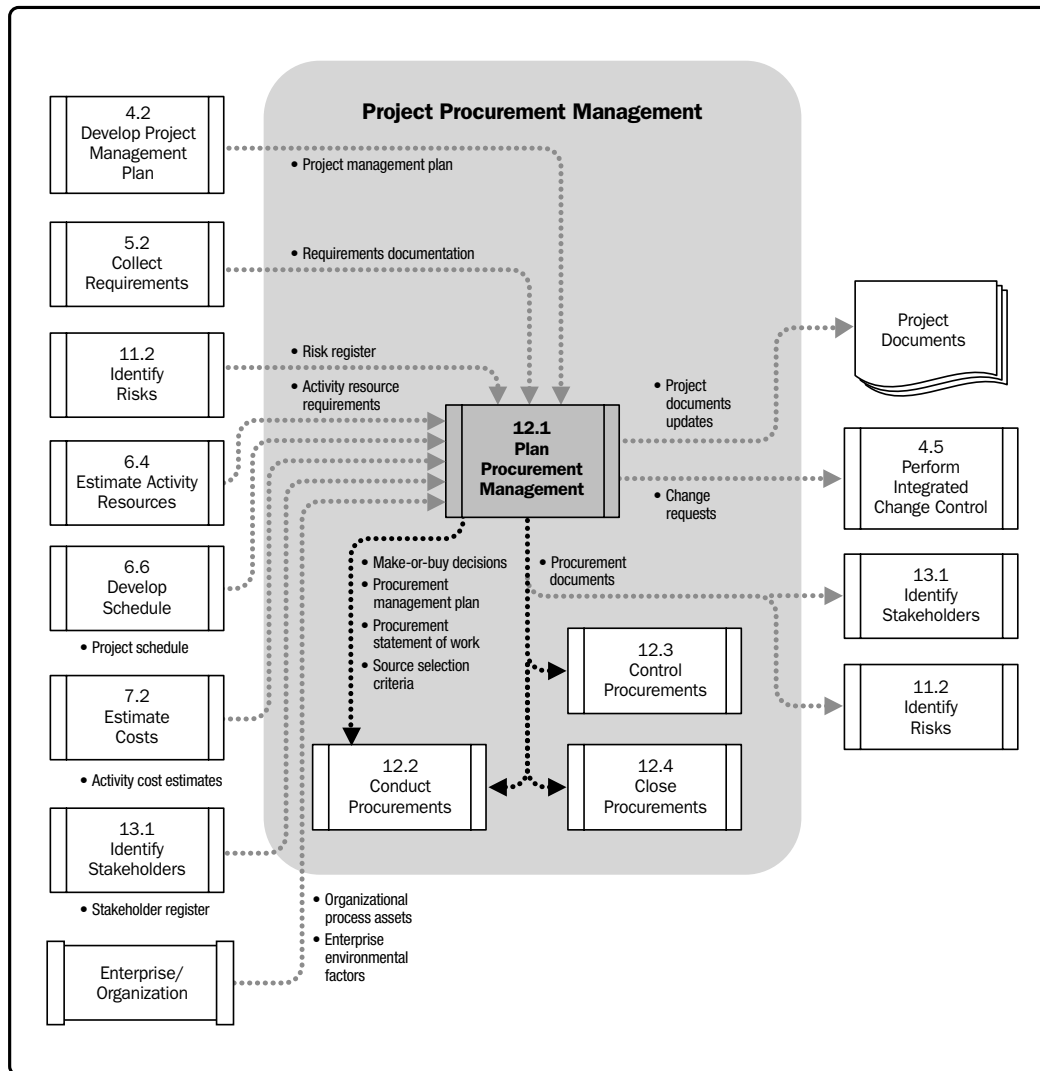

Figure 12-3. Plan Procurement Management Data Flow Diagram

Plan Procurement Management identifies those project needs that can best be met or should be met by acquiring products, services, or results outside of the project organization, versus those project needs which can be accomplished by the project team. When the project obtains products, services, and results required for project performance from outside of the performing organization, the processes from Plan Procurement Management through Close Procurements are performed for each item to be acquired.

The Plan Procurement Management process also includes evaluating potential sellers, particularly if the buyer wishes to exercise some degree of influence or control over acquisition decisions. Thought should also be given to who is responsible for obtaining or holding any relevant permits and professional licenses that may be required by legislation, regulation, or organizational policy in executing the project.

The requirements of the project schedule can significantly influence the strategy during the Plan Procurement Management process. Decisions made in developing the procurement management plan can also influence the project schedule and are integrated with Develop Schedule, Estimate Activity Resources, and make-or-buy analysis.

The Plan Procurement Management process includes evaluating the risks involved with each make-or-buy analysis. It also includes reviewing the type of contract planned to be used with respect to avoiding or mitigating risks, sometimes transferring risks to the seller.

12.1.1 Plan Procurement Management: Inputs

12.1.1.1 Project Management Plan

Described in Section 4.2.3.1. The project management plan describes the need, justification, requirements, and current boundaries for the project. It includes, but is not limited to, the scope baseline contents:

- **Project scope statement.** The project scope statement contains the product scope description, service description and result description, the list of deliverables, and acceptance criteria, as well as important information regarding technical issues or concerns that could impact cost estimating. Identified constraints may include required delivery dates, available skilled resources, and organizational policies.
- **WBS.** The work breakdown structure (WBS) contains the components of work that may be resourced externally.
- **WBS dictionary.** The WBS dictionary and related detailed statements of work provide an identification of the deliverables and a description of the work in each WBS component required to produce each deliverable.

12.1.1.2 Requirements Documentation

Described in Section 5.2.3.1. Requirements documentation may include:

- Important information about project requirements that is considered during planning for procurements, and
- Requirements with contractual and legal implications that may include health, safety, security, performance, environmental, insurance, intellectual property rights, equal employment opportunity, licenses, and permits—all of which are considered when planning for procurements.

12.1.1.3 Risk Register

Described in Section 11.2.3.1. The risk register provides the list of risks, along with the results of risk analysis and risk response planning. Updates to the risk register are included with project document updates described in Section 11.5.3.2, from the Plan Risk Responses process.

12.1.1.4 Activity Resource Requirements

Described in Section 6.4.3.1. Activity resource requirements contain information on specific needs such as people, equipment, or location.

12.1.1.5 Project Schedule

Described in Section 6.6.3.2. Project schedule contains information on required timelines or mandated deliverable dates.

12.1.1.6 Activity Cost Estimates

Described in Section 7.2.3.1. Cost estimates developed by the procuring activity are used to evaluate the reasonableness of the bids or proposals received from potential sellers.

12.1.1.7 Stakeholder Register

Described in Section 13.1.3.1. The stakeholder register provides details on the project participants and their interests in the project.

12.1.1.8 Enterprise Environmental Factors

Described in Section 2.1.5. The enterprise environmental factors that can influence the Plan Procurement Management process include, but are not limited to:

- Marketplace conditions;
- Products, services, and results that are available in the marketplace;
- Suppliers, including past performance or reputation;
- Typical terms and conditions for products, services, and results or for the specific industry; and
- Unique local requirements.

12.1.1.9 Organizational Process Assets

Described in Section 2.1.4. The various types of contractual agreements used by the organization also influence decisions for the Plan Procurement Management process. The organizational process assets that influence the Plan Procurement Management process include, but are not limited to:

- Formal procurement policies, procedures, and guidelines. Most organizations have formal procurement policies and buying organizations. When such procurement support is not available, the project team should supply both the resources and the expertise to perform such procurement activities.
- Management systems that are considered in developing the procurement management plan and selecting the contractual relationships to be used.
- An established multi-tier supplier system of prequalified sellers based on prior experience.

All legal contractual relationships generally fall into one of two broad families: either fixed-price or cost reimbursable. Also, there is a third hybrid type commonly in use called the time and materials contract. The more popular contract types in use are discussed below as discrete types, but in practice it is not unusual to combine one or more types into a single procurement.

- **Fixed-price contracts.** This category of contracts involves setting a fixed total price for a defined product, service, or result to be provided. Fixed-price contracts may also incorporate financial incentives for achieving or exceeding selected project objectives, such as schedule delivery dates, cost and technical performance, or anything that can be quantified and subsequently measured. Sellers under fixed-price contracts are legally obligated to complete such contracts, with possible financial damages if they do not. Under the fixed-price arrangement, buyers need to precisely specify the product or services being procured. Changes in scope may be accommodated, but generally with an increase in contract price.

- *Firm Fixed Price Contracts (FFP)*. The most commonly used contract type is the FFP. It is favored by most buying organizations because the price for goods is set at the outset and not subject to change unless the scope of work changes. Any cost increase due to adverse performance is the responsibility of the seller, who is obligated to complete the effort. Under the FFP contract, the buyer should precisely specify the product or services to be procured, and any changes to the procurement specification can increase the costs to the buyer.
- *Fixed Price Incentive Fee Contracts (FPIF)*. This fixed-price arrangement gives the buyer and seller some flexibility in that it allows for deviation from performance, with financial incentives tied to achieving agreed upon metrics. Typically such financial incentives are related to cost, schedule, or technical performance of the seller. Performance targets are established at the outset, and the final contract price is determined after completion of all work based on the seller's performance. Under FPIF contracts, a price ceiling is set, and all costs above the price ceiling are the responsibility of the seller, who is obligated to complete the work.
- *Fixed Price with Economic Price Adjustment Contracts (FP-EPA)*. This contract type is used whenever the seller's performance period spans a considerable period of years, as is desired with many long-term relationships. It is a fixed-price contract, but with a special provision allowing for pre defined final adjustments to the contract price due to changed conditions, such as inflation changes, or cost increases (or decreases) for specific commodities. The EPA clause needs to relate to some reliable financial index, which is used to precisely adjust the final price. The FP-EPA contract is intended to protect both buyer and seller from external conditions beyond their control.
- **Cost-reimbursable contracts.** This category of contract involves payments (cost reimbursements) to the seller for all legitimate actual costs incurred for completed work, plus a fee representing seller profit. Cost-reimbursable contracts may also include financial incentive clauses whenever the seller exceeds, or falls below, defined objectives such as costs, schedule, or technical performance targets. Three of the more common types of cost-reimbursable contracts in use are Cost Plus Fixed Fee (CPFF), Cost Plus Incentive Fee (CPIF), and Cost Plus Award Fee (CPAF).
A cost-reimbursable contract provides the project flexibility to redirect a seller whenever the scope of work cannot be precisely defined at the start and needs to be altered, or when high risks may exist in the effort.

- *Cost Plus Fixed Fee Contracts (CPFF)*. The seller is reimbursed for all allowable costs for performing the contract work, and receives a fixed-fee payment calculated as a percentage of the initial estimated project costs. A fee is paid only for completed work and does not change due to seller performance. Fee amounts do not change unless the project scope changes.
- *Cost Plus Incentive Fee Contracts (CPIF)*. The seller is reimbursed for all allowable costs for performing the contract work and receives a predetermined incentive fee based upon achieving certain performance objectives as set forth in the contract. In CPIF contracts, if the final costs are less or greater than the original estimated costs, then both the buyer and seller share costs from the departures based upon a prenegotiated cost-sharing formula, for example, an 80/20 split over/under target costs based on the actual performance of the seller.
- *Cost Plus Award Fee Contracts (CPAF)*. The seller is reimbursed for all legitimate costs, but the majority of the fee is earned only based on the satisfaction of certain broad subjective performance criteria defined and incorporated into the contract. The determination of fee is based solely on the subjective determination of seller performance by the buyer, and is generally not subject to appeals.
- **Time and Material Contracts (T&M)**. Time and material contracts are a hybrid type of contractual arrangement that contain aspects of both cost-reimbursable and fixed-price contracts. They are often used for staff augmentation, acquisition of experts, and any outside support when a precise statement of work cannot be quickly prescribed. These types of contracts resemble cost-reimbursable contracts in that they can be left open ended and may be subject to a cost increase for the buyer. The full value of the agreement and the exact quantity of items to be delivered may not be defined by the buyer at the time of the contract award. Thus, T&M contracts can increase in contract value as if they were cost-reimbursable contracts. Many organizations require not-to-exceed values and time limits placed in all T&M contracts to prevent unlimited cost growth. Conversely, T&M contracts can also resemble fixed unit price arrangements when certain parameters are specified in the contract. Unit labor or material rates can be preset by the buyer and seller, including seller profit, when both parties agree on the values for specific resource categories, such as senior engineers at specified rates per hour, or categories of materials at specified rates per unit.

12.1.2 Plan Procurement Management: Tools and Techniques

12.1.2.1 Make-or-Buy Analysis

A make-or-buy analysis is a general management technique used to determine whether particular work can best be accomplished by the project team or should be purchased from outside sources. Sometimes a capability may exist within the project organization, but may be committed to working on other projects, in which case, the project may need to source such effort from outside the organization in order to meet its schedule commitments.

Budget constraints may influence make-or-buy decisions. If a buy decision is to be made, then a further decision of whether to purchase or lease is also made. A make-or-buy analysis should consider all related costs—both direct costs as well as indirect support costs. For example, the buy-side of the analysis includes both the actual out-of-pocket costs to purchase the product, as well as the indirect costs of supporting the purchasing process and purchased item.

Available contract types are also considered during the buy analysis. The risk sharing between the buyer and seller determines the suitable contract types, while the specific contract terms and conditions formalize the degree of risk being assumed by the buyer and seller. Some jurisdictions have other types of contracts defined, for example, contract types based on the obligations of the seller—not the customer—and the contract parties have the obligation to identify the appropriate type of contract as soon as the applicable law has been agreed upon.

12.1.2.2 Expert Judgment

Expert judgment is often used to assess the inputs to and outputs from this process. Expert purchasing judgment can also be used to develop or modify the criteria that will be used to evaluate seller proposals. Expert legal judgment may involve the services of legal staff to assist with unique procurement issues, terms, and conditions. Such judgment, including business and technical expertise, can be applied to both the technical details of the acquired products, services, or results and to various aspects of the procurement management processes.

12.1.2.3 Market Research

Market research includes examination of industry and specific vendor capabilities. Procurement teams may leverage information gained at conferences, online reviews and a variety of sources to identify market capabilities. The team may also refine particular procurement objectives to leverage maturing technologies while balancing risks associated with the breadth of vendors who can provide the materials or services desired.

12.1.2.4 Meetings

Research alone may not provide specific information to formulate a procurement strategy without additional information interchange meetings with potential bidders. By collaborating with potential bidders, the organization purchasing the material or service may benefit while the supplier can influence a mutually beneficial approach or product.

12.1.3 Plan Procurement Management: Outputs

12.1.3.1 Procurement Management Plan

The procurement management plan is a component of the project management plan that describes how a project team will acquire goods and services from outside the performing organization. It describes how the procurement processes will be managed from developing procurement documents through contract closure. The procurement management plan can include guidance for:

- Types of contracts to be used;
- Risk management issues;
- Whether independent estimates will be used and whether they are needed as evaluation criteria;
- Those actions the project management team can take unilaterally, if the performing organization has a prescribed procurement, contracting, or purchasing department;
- Standardized procurement documents, if needed;
- Managing multiple suppliers;
- Coordinating procurement with other project aspects, such as scheduling and performance reporting;
- Any constraints and assumptions that could affect planned procurements;
- Handling the long lead times to purchase certain items from sellers and coordinating the extra time needed to procure these items with the development of the project schedule;
- Handling the make-or-buy decisions and linking them into the Estimate Activity Resources and Develop Schedule processes;

- Setting the scheduled dates in each contract for the contract deliverables and coordinating with the schedule development and control processes;
- Identifying requirements for performance bonds or insurance contracts to mitigate some forms of project risk;
- Establishing the direction to be provided to the sellers on developing and maintaining a work breakdown structure (WBS);
- Establishing the form and format to be used for the procurement/contract statements of work;
- Identifying prequalified sellers, if any, to be used; and
- Procurement metrics to be used to manage contracts and evaluate sellers.

A procurement management plan can be formal or informal, can be highly detailed or broadly framed, and is based upon the needs of each project.

12.1.3.2 Procurement Statement of Work

The statement of work (SOW) for each procurement is developed from the project scope baseline and defines only that portion of the project scope that is to be included within the related contract. The procurement SOW describes the procurement item in sufficient detail to allow prospective sellers to determine if they are capable of providing the products, services, or results. Sufficient detail can vary based on the nature of the item, the needs of the buyer, or the expected contract form. Information included in a SOW can include specifications, quantity desired, quality levels, performance data, period of performance, work location, and other requirements.

The procurement SOW is written to be clear, complete, and concise. It includes a description of any collateral services required, such as performance reporting or post-project operational support for the procured item. In some application areas, there are specific content and format requirements for a procurement SOW. Each individual procurement item requires a SOW; however, multiple products or services can be grouped as one procurement item within a single SOW.

The procurement SOW can be revised and refined as required as it moves through the procurement process until incorporated into a signed agreement.

12.1.3.3 Procurement Documents

Procurement documents are used to solicit proposals from prospective sellers. Terms such as bid, tender, or quotation are generally used when the seller selection decision will be based on price (as when buying commercial or standard items), while a term such as proposal is generally used when other considerations, such as technical capability or technical approach are paramount. Common terms are in use for different types of procurement documents and may include request for information (RFI), invitation for bid (IFB), request for proposal (RFP), request for quotation (RFQ), tender notice, invitation for negotiation, and invitation for seller's initial response. Specific procurement terminology used may vary by industry and location of the procurement.

The buyer structures procurement documents to facilitate an accurate and complete response from each prospective seller and to facilitate easy evaluation of the responses. These documents include a description of the desired form of the response, the relevant procurement statement of work (SOW) and any required contractual provisions. With government contracting, some or all of the content and structure of procurement documents may be defined by regulation.

The complexity and level of detail of the procurement documents should be consistent with the value of, and risks associated with, the planned procurement. Procurement documents are required to be sufficient to ensure consistent, appropriate responses, but flexible enough to allow consideration of any seller suggestions for better ways to satisfy the same requirements.

Issuing a procurement request to potential sellers to submit a proposal or bid is normally done in accordance with the policies of the buyer's organization, which can include publication of the request in public newspapers, in trade journals, in public registries, or on the internet.

12.1.3.4 Source Selection Criteria

Source selection criteria are often included as a part of the procurement documents. Such criteria are developed and used to rate or score seller proposals, and can be objective or subjective.

Selection criteria may be limited to only the purchase price if the procurement item is readily available from a number of acceptable sellers. Purchase price in this context includes both the cost of the item and all ancillary expenses such as delivery.

Other selection criteria can be identified and documented to support an assessment for more complex products, services, or results. Some possible source selection criteria are:

- **Understanding of need.** How well does the seller's proposal address the procurement statement of work?
- **Overall or life-cycle cost.** Will the selected seller produce the lowest total cost of ownership (purchase cost plus operating cost)?
- **Technical capability.** Does the seller have, or can the seller be reasonably expected to acquire, the technical skills and knowledge needed?
- **Risk.** How much risk is embedded in the statement of work, how much risk will be assigned to the selected seller and how does the seller mitigate risk?
- **Management approach.** Does the seller have, or can the seller be reasonably expected to develop, management processes and procedures to ensure a successful project?
- **Technical approach.** Do the seller's proposed technical methodologies, techniques, solutions, and services meet the procurement documents requirements or are they likely to provide more or less than the expected results?
- **Warranty.** What does the seller propose to warrant for the final product, and through what time period?
- **Financial capacity.** Does the seller have, or can the seller reasonably be expected to obtain, the necessary financial resources?
- **Production capacity and interest.** Does the seller have the capacity and interest to meet potential future requirements?
- **Business size and type.** Does the seller's enterprise meet a specific category of business such as small business (disadvantaged, specific programs, etc.) as defined by the organization or established by governmental agency and set forth as a condition of the agreement award?
- **Past performance of sellers.** What has been the past experience with selected sellers?
- **References.** Can the seller provide references from prior customers verifying the seller's work experience and compliance with contractual requirements?
- **Intellectual property rights.** Does the seller assert intellectual property rights in the work processes or services they will use or in the products they will produce for the project?
- **Proprietary rights.** Does the seller assert proprietary rights in the work processes or services they will use or in the products they will produce for the project?

12.1.3.5 Make-or-Buy Decisions

A make-or-buy analysis results in a decision of whether particular work can best be accomplished by the project team or needs to be purchased from outside sources. If the decision is to make the item, then the procurement plan may define processes and agreements internal to the organization. A buy decision drives a similar process of reaching agreement with a supplier for the product or services.

12.1.3.6 Change Requests

A decision that involves procuring goods, services, or resources typically requires a change request. Other decisions during procurement planning can also create the need for additional change requests. Change requests are processed for review and disposition through the Perform Integrated Change Control process (Section 4.5). Changes to the project management plan, its subsidiary plans, and other components may result in change requests that impact procurement actions. Change requests are processed for review and disposition through the Perform Integrated Change Control process (Section 4.5).

12.1.3.7 Project Documents Updates

Project documents that may be updated include, but are not limited to:

- Requirements documentation,
- Requirements traceability matrix, and
- Risk register.

12.2 Conduct Procurements

Conduct Procurements is the process of obtaining seller responses, selecting a seller, and awarding a contract. The key benefit of this process is that it provides alignment of internal and external stakeholder expectations through established agreements. The inputs, tools and techniques, and outputs of this process are depicted in Figure 12-4. Figure 12-5 depicts the data flow diagram of the process.

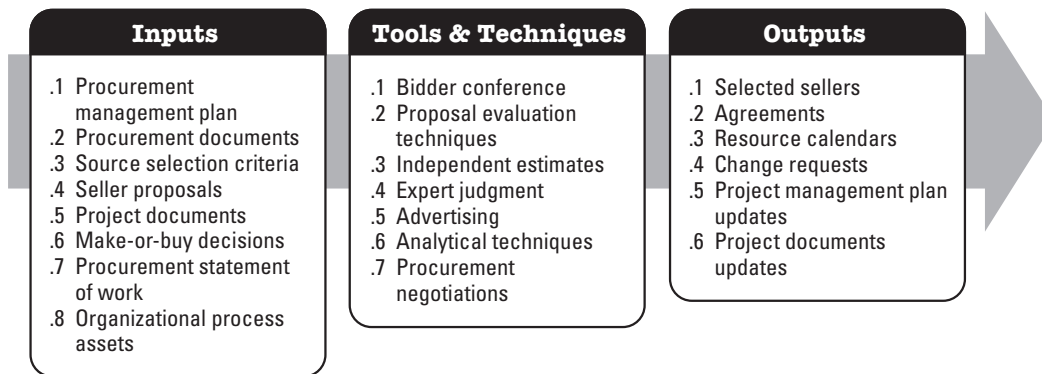

Figure 12-4. Conduct Procurements: Inputs, Tools & Techniques, and Outputs

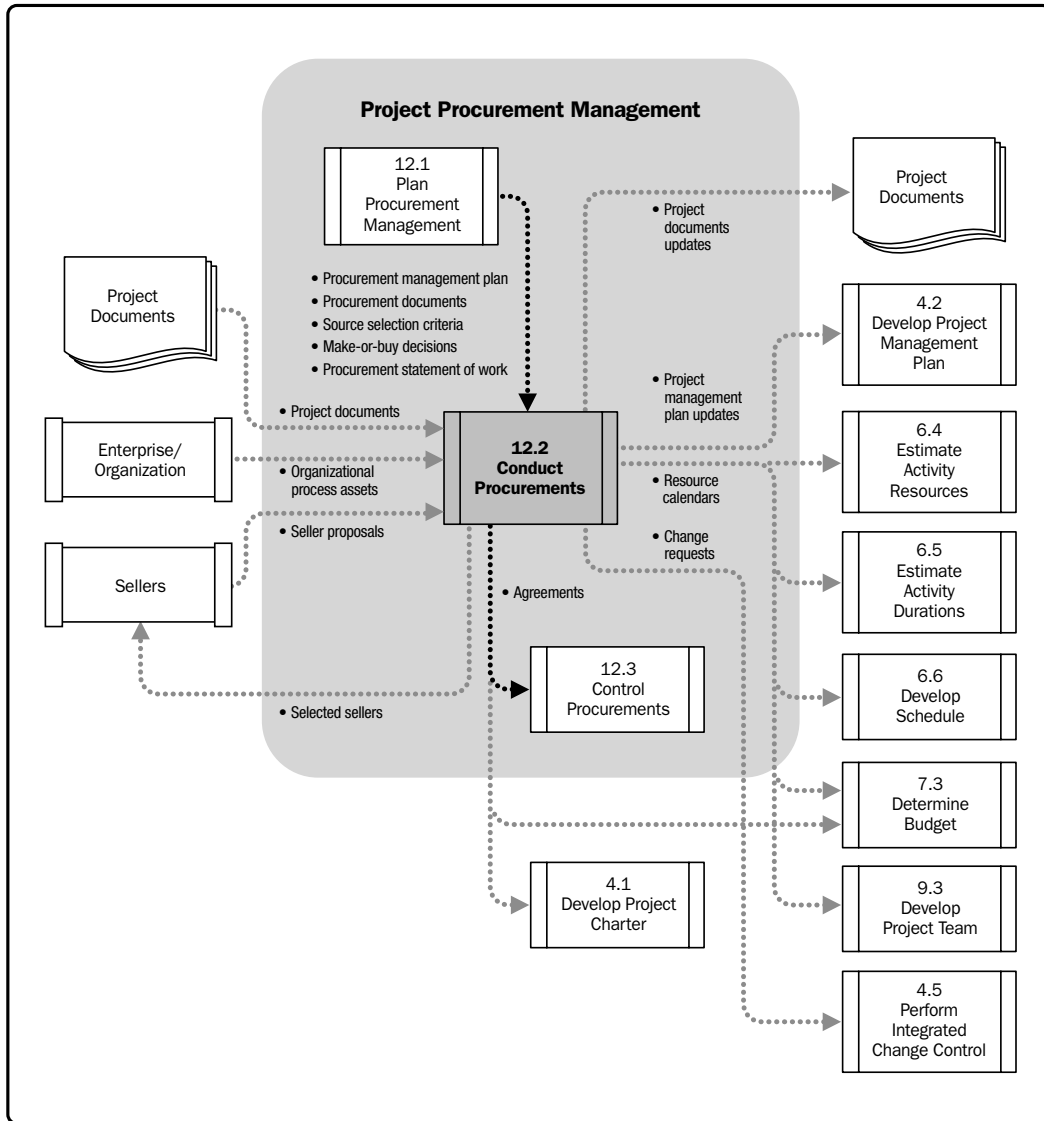

Figure 12-5. Conduct Procurements Data Flow Diagram

During the Conduct Procurements process, the team will receive bids or proposals and will apply previously defined selection criteria to select one or more sellers who are qualified to perform the work and acceptable as a seller.

On major procurement items, the overall process of requesting responses from sellers and evaluating those responses can be repeated. A short list of qualified sellers can be established based on a preliminary proposal. A more detailed evaluation can then be conducted based on a more specific and comprehensive requirements document requested from the sellers on the short list. In addition, tools and techniques described here may be used alone or in combination with select sellers. For example, a weighting system can be used to:

- Select a single seller that will be asked to sign a standard contract; and
- Establish a negotiating sequence by ranking all proposals by the weighted evaluation scores assigned to each proposal.

12.2.1 Conduct Procurements: Inputs

12.2.1.1 Procurement Management Plan

Described in Section 4.2.3.1. The procurement management plan describes how the procurement processes will be managed from developing procurement documentation through contract closure.

12.2.1.2 Procurement Documents

Described in Section 12.1.3.3. Procurement documents provide an audit trail for contracts and other agreements.

12.2.1.3 Source Selection Criteria

Described in Section 12.1.3.4.

Source selection criteria can include information on the supplier's required capabilities, capacity, delivery dates, product cost, life-cycle cost, technical expertise, and the approach to the contract.

12.2.1.4 Seller Proposals

Seller proposals, prepared in response to a procurement document package, form the basic information that will be used by an evaluation body to select one or more successful bidders (sellers).

12.2.1.5 Project Documents

Described in Section 11.5.3.2. Project documents that are often considered include the risk-related contract decisions included within the risk register.

12.2.1.6 Make-or-Buy Decisions

Described in Section 12.1.3.5. Organizations procuring goods or services analyze the need, identify resources, and then compare procurement strategies when deciding to buy. Organizations also evaluate the need of buying products versus making the items themselves. Factors that influence make-or-buy decisions may include:

- Core capabilities of the organization,
- Value delivered by vendors meeting the need,
- Risks associated with meeting the need in a cost-effective manner, and
- Capability internally compared with the vendor community.

12.2.1.7 Procurement Statement of Work

Described in Section 12.1.3.2. The procurement statement of work provides suppliers with a clearly stated set of goals, requirements, and outcomes from which they can provide a quantifiable response. The statement of work is a critical component of the procurement process and can be modified as needed through this process until a final agreement is in place. The statements of work may include, but are not limited to:

- Specifications,
- Quantity desired,
- Quality levels,
- Performance data,
- Period of performance,
- Work location, and
- Other requirements.

12.2.1.8 Organizational Process Assets

Described in Section 2.1.4. Elements of the organizational process assets that can influence the Conduct Procurements process include, but are not limited to:

- Listings of prospective and previously qualified sellers,
- Information on relevant past experience with sellers, both good and bad, and
- Prior agreements.

Whenever a prior agreement is in place, the buyer and seller roles will have already been decided by executive management. In some cases, the seller may already be working under a contract funded by the buyer or jointly by both parties. The effort of the buyer and seller in this process is to collectively prepare a procurement statement of work that will satisfy the requirements of the project. The parties will then negotiate a final contract for award.

12.2.2 Conduct Procurements: Tools and Techniques

12.2.2.1 Bidder Conferences

Bidder conferences (sometimes called contractor conferences, vendor conferences, and pre-bid conferences) are meetings between the buyer and all prospective sellers prior to submittal of a bid or proposal. They are used to ensure that all prospective sellers have a clear and common understanding of the procurement requirements), and that no bidders receive preferential treatment. To be fair, buyers should take great care to ensure that all prospective sellers hear every question from any individual prospective seller and every answer from the buyer. Typically fairness is addressed by techniques such as collecting questions from bidders or arranging field visits in advance of the bidder conference. Responses to questions can be incorporated into the procurement documents as amendments.

12.2.2.2 Proposal Evaluation Techniques

On complex procurements, where source selection will be made based on seller responses to previously defined weighted criteria, a formal evaluation review process will be defined by the buyer's procurement policies. The evaluation committee will make their selection for approval by management prior to the award.

12.2.2.3 Independent Estimates

For many procurement items, the procuring organization may elect to either prepare its own independent estimate, or have an estimate of costs prepared by an outside professional estimator, to serve as a benchmark on proposed responses. Significant differences in cost estimates can be an indication that the procurement statement of work was deficient, ambiguous, and/or that the prospective sellers either misunderstood or failed to respond fully to the procurement statement of work.

12.2.2.4 Expert Judgment

Expert judgment may be used in evaluating seller proposals. The evaluation of proposals may be accomplished by a multi-discipline review team with expertise in each of the areas covered by the procurement documents and proposed contract. This can include expertise from functional disciplines such as contracting, legal, finance, accounting, engineering, design, research, development, sales, and manufacturing.

12.2.2.5 Advertising

Existing lists of potential sellers often can be expanded by placing advertisements in general circulation publications such as selected newspapers or in specialty trade publications. Some organizations use online resources to communicate solicitations to the vendor community. Some government jurisdictions require public advertising of certain types of procurement items, and most government jurisdictions require public advertising or online posting of pending government contracts.

12.2.2.6 Analytical Techniques

Procurements involve defining a need in such a way that vendors can bring value through their offerings. To ensure that the need can be and is met, analytical techniques can help organizations identify the readiness of a vendor to provide the desired end state, determine the cost expected to support budgeting, and avoid cost overruns due to changes. By examining past performance information, teams may identify areas that may have more risk and that need to be monitored closely to ensure success of the project.

12.2.2.7 Procurement Negotiations

Procurement negotiations clarify the structure, requirements, and other terms of the purchases so that mutual agreement can be reached prior to signing the contract. Final contract language reflects all agreements reached. Subjects covered should include responsibilities, authority to make changes, applicable terms and governing law, technical and business management approaches, proprietary rights, contract financing, technical solutions, overall schedule, payments, and price. Negotiations conclude with a contract document that can be executed by both buyer and seller.

For complex procurement items, contract negotiation can be an independent process with inputs (e.g., issues or an open items listing) and outputs (e.g., documented decisions) of its own. For simple procurement items, the terms and conditions of the contract can be previously set and nonnegotiable, and only need to be accepted by the seller.

The project manager may not be the lead negotiator on procurements. The project manager and other members of the project management team may be present during negotiations to provide assistance, and, if needed, to add clarification of the project's technical, quality, and management requirements.

12.2.3 Conduct Procurements: Outputs

12.2.3.1 Selected Sellers

The selected sellers are those who have been judged to be in a competitive range based upon the outcome of the proposal or bid evaluation, and who have negotiated a draft contract that will become the actual contract when an award is made. Final approval of all complex, high-value, high-risk procurements will generally require organizational senior management approval prior to award.

12.2.3.2 Agreements

A procurement agreement includes terms and conditions, and may incorporate other items that the buyer specifies regarding what the seller is to perform or provide. It is the project management team's responsibility to make certain that all agreements meet the specific needs of the project while adhering to organizational procurement policies. Depending upon the application area, an agreement can also be called an understanding, a contract, a subcontract, or a purchase order. Regardless of the document's complexity, a contract is a mutually binding legal agreement that obligates the seller to provide the specified products, services, or results, and obligates the buyer to compensate the seller. A contract is a legal relationship subject to remedy in the courts. The major components in an agreement document will vary, but may include the following:

- Statement of work or deliverables,
- Schedule baseline,
- Performance reporting,
- Period of performance,
- Roles and responsibilities,
- Seller's place of performance,
- Pricing,
- Payment terms,
- Place of delivery,
- Inspection and acceptance criteria,
- Warranty,
- Product support,
- Limitation of liability,
- Fees and retainer,
- Penalties,
- Incentives,
- Insurance and performance bonds,
- Subordinate subcontractor approvals,
- Change request handling, and
- Termination clause and alternative dispute resolution (ADR) mechanisms. The ADR method can be decided in advance as a part of the procurement award.

12.2.3.3 Resource Calendars

The quantity and availability of contracted resources and those dates on which each specific resource or resource group can be active or idle are documented.

12.2.3.4 Change Requests

Change requests to the project management plan, its subsidiary plans, and other components are processed for review and disposition through the Perform Integrated Change Control process (Section 4.5).

12.2.3.5 Project Management Plan Updates

Elements of the project management plan that may be updated include, but are not limited to:

- Cost baseline,
- Scope baseline,
- Schedule baseline,
- Communications management plan, and
- Procurement management plan.

12.2.3.6 Project Documents Updates

Project documents that may be updated include, but are not limited to:

- Requirements documentation,
- Requirements traceability documentation,
- Risk register, and
- Stakeholder register.

12.3 Control Procurements

Control Procurements is the process of managing procurement relationships, monitoring contract performance, and making changes and corrections to contracts as appropriate. The key benefit of this process is that it ensures that both the seller's and buyer's performance meets procurement requirements according to the terms of the legal agreement. The inputs, tools and techniques, and outputs of this process are depicted in Figure 12-6. Figure 12-7 depicts the data flow diagram of the process.

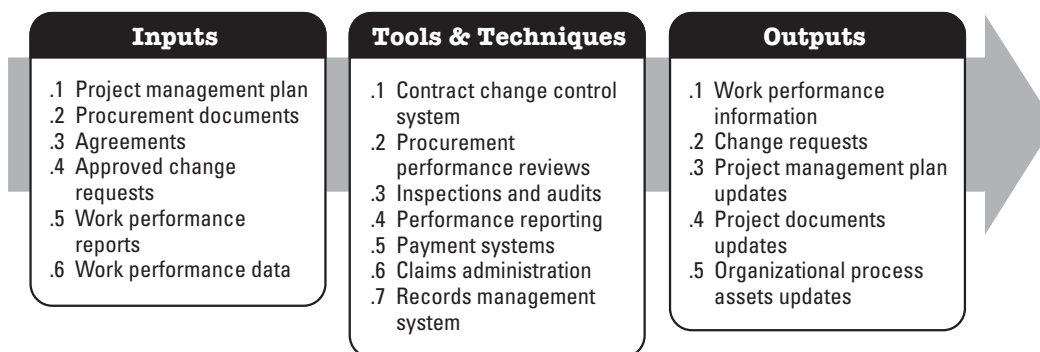

Figure 12-6. Control Procurements: Inputs, Tools & Techniques, and Outputs

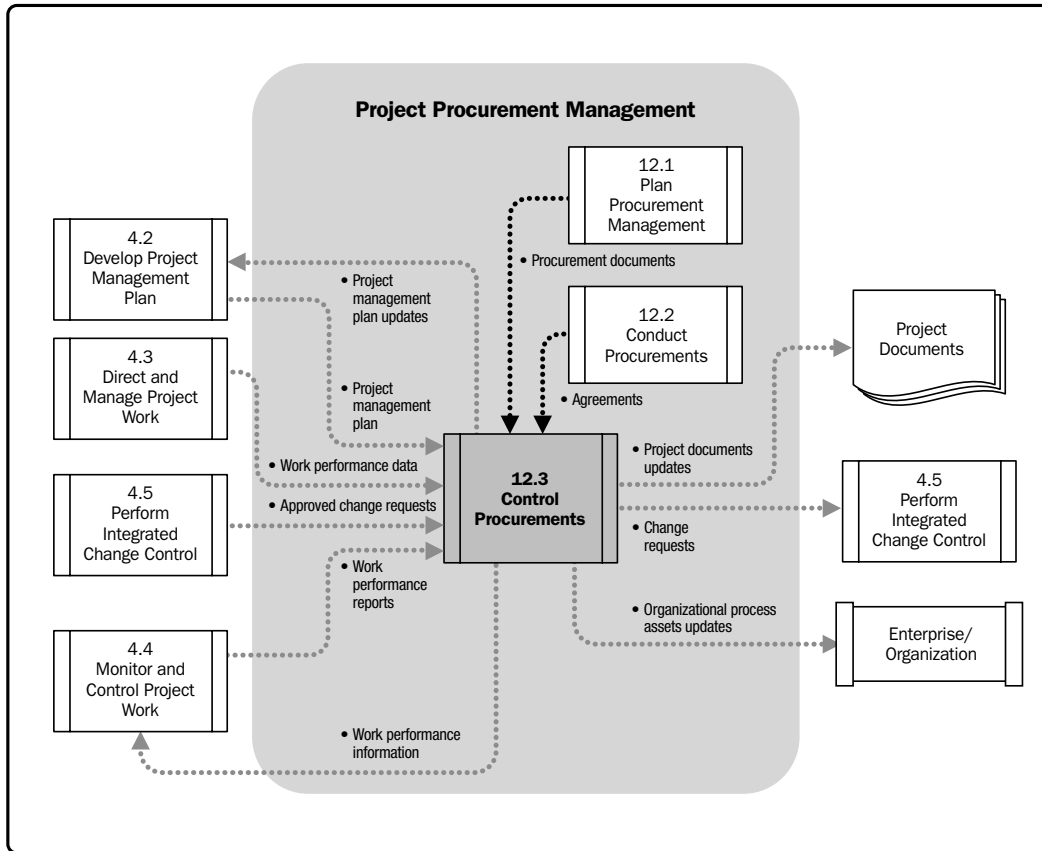

Figure 12-7. Control Procurements Data Flow Diagram

Both the buyer and the seller will administer the procurement contract for similar purposes. Each are required to ensure that both parties meet their contractual obligations and that their own legal rights are protected. The legal nature of the contractual relationship makes it imperative that the project management team is aware of the legal implications of actions taken when controlling any procurement. On larger projects with multiple providers, a key aspect of contract administration is managing interfaces among the various providers.

Due to varying organizational structures, many organizations treat contract administration as an administrative function separate from the project organization. While a procurement administrator may be on the project team, this individual typically reports to a supervisor from a different department. This is usually true if the performing organization is also the seller of the project to an external customer.

Control Procurements includes application of the appropriate project management processes to the contractual relationship(s) and integration of the outputs from these processes into the overall management of the project. This integration will often occur at multiple levels when there are multiple sellers and multiple products, services, or results involved. The project management processes that are applied may include, but are not limited to:

- **Direct and Manage Project Work.** To authorize the seller's work at the appropriate time.
- **Control Quality.** To inspect and verify the adequacy of the seller's product.
- **Perform Integrated Change Control.** To assure that changes are properly approved and that all those with a need to know are aware of such changes.
- **Control Risks.** To ensure that risks are mitigated.

Control Procurements also has a financial management component that involves monitoring payments to the seller. This ensures that payment terms defined within the contract are met and that seller compensation is linked to seller progress, as defined in the contract. One of the principal concerns when making payments to suppliers is that there is a close relationship of payments made to the work accomplished.

The Control Procurements process reviews and documents how well a seller is performing or has performed based on the contract and establishes corrective actions when needed. This performance review may be used as a measure of the seller's competency for performing similar work on future projects. Similar evaluations are also carried out when it is necessary to confirm that a seller is not meeting the seller's contractual obligations and when the buyer contemplates corrective actions. Control Procurements includes capturing the necessary details for managing any early terminations of the contracted work (for cause, convenience, or default) in accordance with the termination clause of the agreement. These details are used in the Close Procurements process to terminate the agreement.

Agreements can be amended at any time prior to contract closure by mutual consent, in accordance with the change control terms of the agreement. Such amendments are typically captured in writing.

12.3.1 Control Procurements: Inputs

12.3.1.1 Project Management Plan

Described in Section 4.2.3.1. The project management plan describes how the procurement processes will be managed from developing procurement documentation through contract closure.

12.3.1.2 Procurement Documents

Described in Section 12.1.3.3. Procurement documents contain complete supporting records for administration of the procurement processes; this includes procurement contract awards and the statement of work.

12.3.1.3 Agreements

Described in Section 12.2.3.2. Agreements are understandings between parties, including understanding of the duties of each party.

12.3.1.4 Approved Change Requests

Approved change requests can include modifications to the terms and conditions of the contract, including the procurement statement of work, pricing, and descriptions of the products, services, or results to be provided. All procurement-related changes are formally documented in writing and approved before being implemented through the Control Procurements process.

12.3.1.5 Work Performance Reports

Described in Section 4.4.3.2. Seller performance-related documentation includes:

- **Technical documentation.** Seller-developed technical documentation and other deliverable information are provided in accordance with the terms of the contract.
- **Work performance information.** The seller's performance reports indicate which deliverables have been completed and which have not.

12.3.1.6 Work Performance Data

Described in Section 4.3.3.2. Work performance data includes (1) the extent to which quality standards are being satisfied, (2) the costs that have been incurred or committed, and (3) identification of the seller invoices that have been paid. All data are collected as part of project execution.

12.3.2 Control Procurements: Tools and Techniques

12.3.2.1 Contract Change Control System

A contract change control system defines the process by which the procurement can be modified. It includes the paperwork, tracking systems, dispute resolution procedures, and approval levels necessary for authorizing changes. The contract change control system is integrated with the integrated change control system.

12.3.2.2 Procurement Performance Reviews

A procurement performance review is a structured review of the seller's progress to deliver project scope and quality, within cost and on schedule, as compared to the contract. It can include a review of seller-prepared documentation and buyer inspections, as well as quality audits conducted during seller's execution of the work. The objective of a performance review is to identify performance successes or failures, progress with respect to the procurement statement of work, and contract noncompliance, which allow the buyer to quantify the seller's demonstrated ability or inability to perform work. Such reviews may take place as a part of project status reviews, which would include key suppliers.

12.3.2.3 Inspections and Audits

Inspections and audits required by the buyer and supported by the seller, as specified in the procurement contract, can be conducted during execution of the project to verify compliance in the seller's work processes or deliverables. If authorized by contract, some inspection and audit teams can include buyer procurement personnel.

12.3.2.4 Performance Reporting

Work performance data and reports supplied by sellers are evaluated against the agreement requirements. Work performance information from this evaluation is then reported as appropriate. Performance reporting provides management with information about how effectively the seller is achieving the contractual objectives.

12.3.2.5 Payment Systems

Payments to the seller are typically processed by the accounts payable system of the buyer after certification of satisfactory work by an authorized person on the project team. All payments should be made and documented in strict accordance with the terms of the contract.

12.3.2.6 Claims Administration

Contested changes and potential constructive changes are those requested changes where the buyer and seller cannot reach an agreement on compensation for the change or cannot agree that a change has occurred. These contested changes are variously called claims, disputes, or appeals. Claims are documented, processed, monitored, and managed throughout the contract life cycle, usually in accordance with the terms of the contract. If the parties themselves do not resolve a claim, it may have to be handled in accordance with alternative dispute resolution (ADR) typically following procedures established in the contract. Settlement of all claims and disputes through negotiation is the preferred method.

12.3.2.7 Records Management System

A records management system is used by the project manager to manage contract and procurement documentation and records. It consists of a specific set of processes, related control functions, and automation tools that are consolidated and combined as part of the project management information system (Section 4.4.2.3). The system contains a retrievable archive of contract documents and correspondence.

12.3.3 Control Procurements: Outputs

12.3.3.1 Work Performance Information

Work performance information provides a basis for identification of current or potential problems to support later claims or new procurements. By reporting on the performance of a vendor, the organization increases knowledge of the performance of the procurement, which supports improved forecasting, risk management, and decision making. Performance reports also assist in the event there is a dispute with the vendor.

Work performance information includes reporting compliance of contracts, which provides procuring organizations a mechanism to track specific deliverables expected and received from vendors. Contract compliance reports support improved communications with vendors so that potential issues are addressed promptly to the satisfaction of all parties.

12.3.3.2 Change Requests

Change requests to the project management plan, its subsidiary plans, and other components, such as the cost baseline, schedule baseline, and procurement management plan, may result from the Control Procurements process. Change requests are processed for review and approval through the Perform Integrated Change Control process.

Requested but unresolved changes can include direction provided by the buyer or actions taken by the seller, which the other party considers a constructive change to the contract. Since any of these constructive changes may be disputed by one party and can lead to a claim against the other party, such changes are uniquely identified and documented by project correspondence.

12.3.3.3 Project Management Plan Updates

Elements of the project management plan that may be updated include, but are not limited to:

- **Procurement management plan.** The procurement management plan is updated to reflect any approved change requests that affect procurement management, including impacts to costs or schedules.
- **Schedule baseline.** If there are slippages that impact overall project performance, the schedule baseline may need to be updated to reflect the current expectations.
- **Cost baseline.** If there are changes that impact overall project costs, the cost baseline may need to be updated to reflect the current expectations.

12.3.3.4 Project Documents Updates

Project documents that may be updated include, but are not limited to, procurement documentation. Procurement documentation may include the procurement contract with all supporting schedules, requested unapproved contract changes, and approved change requests. Procurement documentation also includes any seller-developed technical documentation and other work performance information, such as deliverables, seller performance reports and warranties, financial documents including invoices and payment records, and the results of contract-related inspections.

12.3.3.5 Organizational Process Assets Updates

Elements of the organizational process assets that may be updated include, but are not limited to:

- **Correspondence.** Contract terms and conditions often require written documentation of certain aspects of buyer/seller communications, such as the need for warnings of unsatisfactory performance and requests for contract changes or clarification. This can include the reported results of buyer audits and inspections that indicate weaknesses the seller needs to correct. In addition to specific contract requirements for documentation, a complete and accurate written record of all written and oral contract communications, as well as actions taken and decisions made, are maintained by both parties.
- **Payment schedules and requests.** All payments should be made in accordance with the procurement contract terms and conditions.
- **Seller performance evaluation documentation.** Seller performance evaluation documentation is prepared by the buyer. Such performance evaluations document the seller's ability to continue to perform work on the current contract, indicate if the seller can be allowed to perform work on future projects, or rate how well the seller is performing the project work. These documents may form the basis for early termination of the seller's contract or determine how contract penalties, fees, or incentives are administered. The results of these performance evaluations can also be included in the appropriate qualified seller lists.

12.4 Close Procurements

Close Procurements is the process of completing each procurement. The key benefit of this process is that it documents agreements and related documentation for future reference. The inputs, tools and techniques, and outputs of this process are depicted in Figure 12-8. Figure 12-9 depicts the data flow diagram of the process.

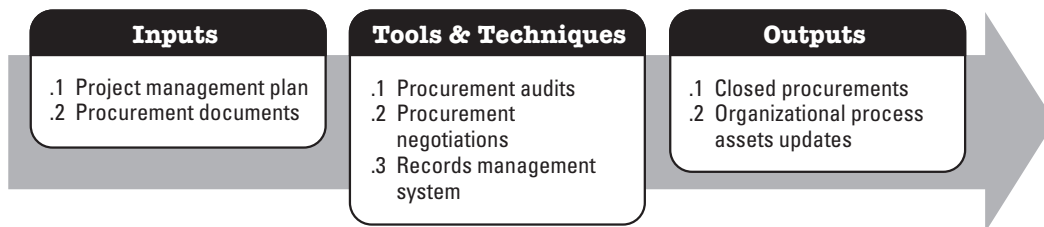

Figure 12-8. Close Procurements: Inputs, Tools & Techniques, and Outputs

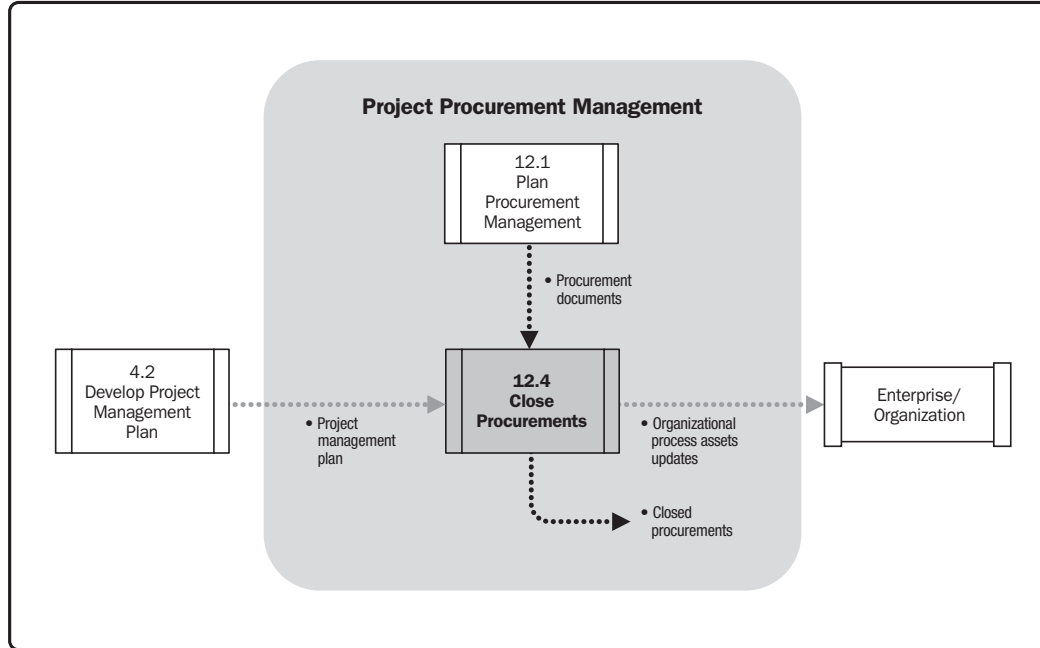

Figure 12-9. Close Procurements Data Flow Diagram

The Close Procurements process also involves administrative activities such as finalizing open claims, updating records to reflect final results, and archiving such information for future use. Close Procurements addresses each contract applicable to the project or a project phase. In multiphase projects, the term of a contract may only be applicable to a given phase of the project. In these cases, the Close Procurements process closes the procurement(s) applicable to that phase of the project. Unresolved claims may be subject to litigation after closure. The contract terms and conditions can prescribe specific procedures for agreement closure. The Close Procurements process supports the Close Project or Phase process (Section 4.6) by ensuring contractual agreements are completed or terminated.

Early termination of a contract is a special case of procurement closure that can result from a mutual agreement by both parties, from the default of one party, or for convenience of the buyer if provided for in the contract. The rights and responsibilities of the parties in the event of an early termination are contained in the terminations clause of the contract. Based upon those procurement terms and conditions, the buyer may have the right to terminate the whole contract or a portion of the contract, at any time, for cause or convenience. However, based upon those contract terms and conditions, the buyer may have to compensate the seller for seller's preparations and for any completed and accepted work related to the terminated part of the contract.

12.4.1 Close Procurements: Inputs

12.4.1.1 Project Management Plan

Described in Section 4.2.3.1. The project management plan contains the procurement management plan, which provides the details and guidelines for closing out procurements.

12.4.1.2 Procurement Documents

To close the contract, all procurement documentation is collected, indexed, and filed. Information on contract schedule, scope, quality, and cost performance along with all contract change documentation, payment records, and inspection results are cataloged. This information can be used for lessons learned information and as a basis for evaluating contractors for future contracts.

12.4.2 Close Procurements: Tools and Techniques

12.4.2.1 Procurement Audits

A procurement audit is a structured review of the procurement process originating from the Plan Procurement Management process through Control Procurements. The objective of a procurement audit is to identify successes and failures that warrant recognition in the preparation or administration of other procurement contracts on the project, or on other projects within the performing organization.

12.4.2.2 Procurement Negotiations

In all procurement relationships, the final equitable settlement of all outstanding issues, claims, and disputes by negotiation is a primary goal. Whenever settlement cannot be achieved through direct negotiation, some form of alternative dispute resolution (ADR) including mediation or arbitration may be explored. When all else fails, litigation in the courts is the least desirable option.

12.4.2.3 Records Management System

Described in Section 12.3.2.7. A records management system is used by the project manager to manage contract and procurement documentation and records. Contract documents and correspondence are archived through the records management system as part of the Close Procurements process.

12.4.3 Close Procurements: Outputs

12.4.3.1 Closed Procurements

The buyer, usually through its authorized procurement administrator, provides the seller with formal written notice that the contract has been completed. Requirements for formal procurement closure are usually defined in the terms and conditions of the contract and are included in the procurement management plan.

12.4.3.2 Organizational Process Assets Updates

Elements of the organizational process assets that may be updated include, but are not limited to:

- **Procurement file.** A complete set of indexed contract documentation, including the closed contract, is prepared for inclusion with the final project files.
- **Deliverable acceptance.** Documentation of formal acceptance of seller-provided deliverables may be required to be retained by the organization. The Close Procurement process ensures this documentation requirement is satisfied. Requirements for formal deliverable acceptance and how to address nonconforming deliverables are usually defined in the agreement.
- **Lessons learned documentation.** Lessons learned, what has been experienced, and process improvement recommendations, should be developed for the project file to improve future procurements.

13

PROJECT STAKEHOLDER MANAGEMENT

Project Stakeholder Management includes the processes required to identify the people, groups, or organizations that could impact or be impacted by the project, to analyze stakeholder expectations and their impact on the project, and to develop appropriate management strategies for effectively engaging stakeholders in project decisions and execution. Stakeholder management also focuses on continuous communication with stakeholders to understand their needs and expectations, addressing issues as they occur, managing conflicting interests and fostering appropriate stakeholder engagement in project decisions and activities. Stakeholder satisfaction should be managed as a key project objective.

Figure 13-1 provides an overview of the Project Stakeholder Management processes that include the following:

- 13.1 Identify Stakeholders**—The process of identifying the people, groups, or organizations that could impact or be impacted by a decision, activity, or outcome of the project; and analyzing and documenting relevant information regarding their interests, involvement, interdependencies, influence, and potential impact on project success.
- 13.2 Plan Stakeholder Management**—The process of developing appropriate management strategies to effectively engage stakeholders throughout the project life cycle, based on the analysis of their needs, interests, and potential impact on project success.
- 13.3 Manage Stakeholder Engagement**—The process of communicating and working with stakeholders to meet their needs/expectations, address issues as they occur, and foster appropriate stakeholder engagement in project activities throughout the project life cycle.
- 13.4 Control Stakeholder Engagement**—The process of monitoring overall project stakeholder relationships and adjusting strategies and plans for engaging stakeholders.

These processes interact with each other and with processes in other Knowledge Areas as described in detail in Section 3 and Annex A1.

Every project will have stakeholders who are impacted by or can impact the project in a positive or negative way. While some stakeholders may have a limited ability to influence the project, others may have significant influence on the project and its expected outcomes. The ability of the project manager to correctly identify and manage these stakeholders in an appropriate manner can mean the difference between success and failure.

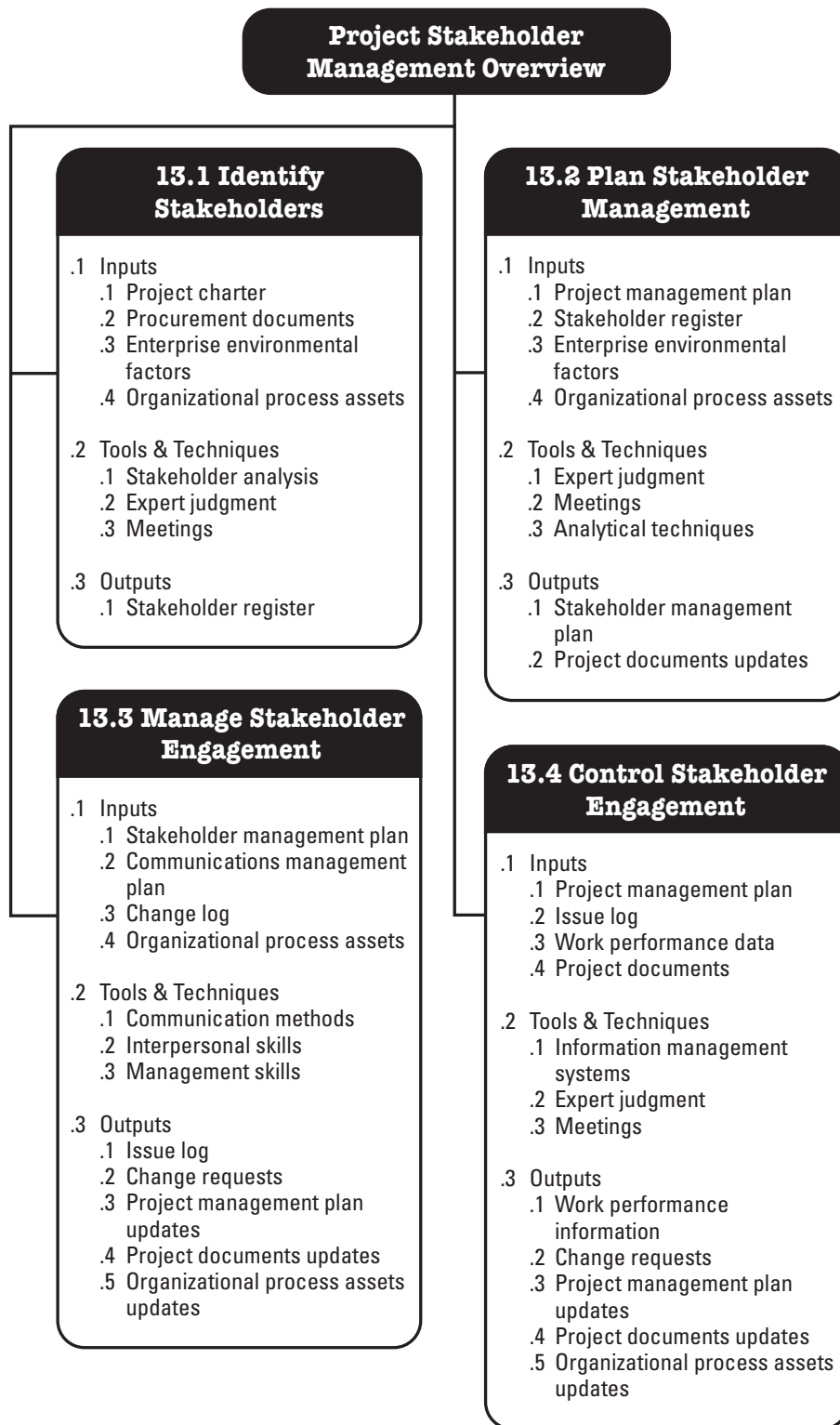

Figure 13-1. Project Stakeholder Management Overview

13.1 Identify Stakeholders

Identify Stakeholders is the process of identifying the people, groups, or organizations that could impact or be impacted by a decision, activity, or outcome of the project, analyzing and documenting relevant information regarding their interests, involvement, interdependencies, influence, and potential impact on project success. The key benefit of this process is that it allows the project manager to identify the appropriate focus for each stakeholder or group of stakeholders. The inputs, tools and techniques, and outputs of this process are depicted in Figure 13-2. Figure 13-3 depicts the data flow diagram of the process.



Figure 13-2. Identify Stakeholders: Inputs, Tools & Techniques, and Outputs

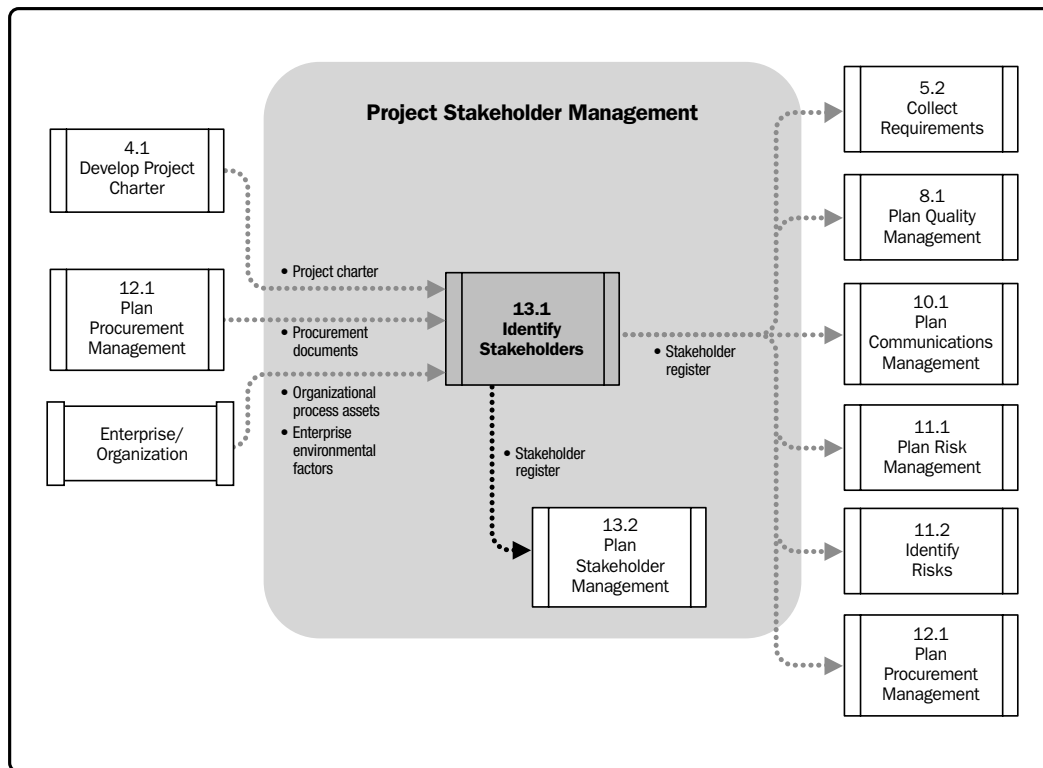

Figure 13-3. Identify Stakeholders Data Flow Diagram

Project stakeholders are individuals, groups, or organizations who may affect, be affected by, or perceive themselves to be affected by a decision, activity, or outcome of a project. They are comprised of persons and organizations such as customers, sponsors, the performing organization, and the public who are actively involved in the project, or whose interests may be positively or negatively affected by the execution or completion of the project. They may also exert influence over the project and its deliverables. Stakeholders may be at different levels within the organization and may possess different authority levels, or may be external to the performing organization for the project. Section 13.1.2.1 identifies various types of project stakeholders.

It is critical for project success to identify the stakeholders early in the project or phase and to analyze their levels of interest, their individual expectations, as well as their importance and influence. This initial assessment should be reviewed and updated regularly. Most projects will have a diverse number of stakeholders depending on their size, type, and complexity. While the project manager's time is limited and should be used as efficiently as possible, these stakeholders should be classified according to their interest, influence, and involvement in the project, taking into consideration the fact that the affect or influence of a stakeholder may not occur or become evident until later stages in the project or phase. This enables the project manager to focus on the relationships necessary to ensure the success of the project.

13.1.1 Identify Stakeholders: Inputs

13.1.1.1 Project Charter

Described in Section 4.1.3.1. The project charter can provide information about internal and external parties related with the project and affected by the result or the execution of the project, such as project sponsor(s), customers, team members, groups and departments participating in the project, and other people or organizations affected by the project.

13.1.1.2 Procurement Documents

Described in Section 12.1.3.3. If a project is the result of a procurement activity or is based on an established contract, the parties in that contract are key project stakeholders. Other relevant parties, such as suppliers, should also be considered as part of the project stakeholder list.

13.1.1.3 Enterprise Environmental Factors

Described in Section 2.1.5. The enterprise environmental factors that can influence the Identify Stakeholders process include, but are not limited to:

- Organizational culture and structure;
- Governmental or industry standards (e.g., regulations, product standards); and
- Global, regional or local trends, and practices or habits.

13.1.1.4 Organizational Process Assets

Described in Section 2.1.4. The organizational process assets that can influence the Identify Stakeholders process include, but are not limited to:

- Stakeholder register templates,
- Lessons learned from previous projects or phases, and
- Stakeholder registers from previous projects.

13.1.2 Identify Stakeholders: Tools and Techniques

13.1.2.1 Stakeholder Analysis

Stakeholder analysis is a technique of systematically gathering and analyzing quantitative and qualitative information to determine whose interests should be taken into account throughout the project. It identifies the interests, expectations, and influence of the stakeholders and relates them to the purpose of the project. It also helps to identify stakeholder relationships (with the project and with other stakeholders) that can be leveraged to build coalitions and potential partnerships to enhance the project's chance of success, along with stakeholder relationships that need to be influenced differently at different stages of the project or phase.

Stakeholder analysis generally follows the steps described below:

- Identify all potential project stakeholders and relevant information, such as their roles, departments, interests, knowledge, expectations, and influence levels. Key stakeholders are usually easy to identify. They include anyone in a decision-making or management role who is impacted by the project outcome, such as the sponsor, the project manager, and the primary customer. Identifying other stakeholders is usually done by interviewing identified stakeholders and expanding the list until all potential stakeholders are included.
- Analyze the potential impact or support each stakeholder could generate, and classify them so as to define an approach strategy. In large stakeholder communities, it is important to prioritize the stakeholders to ensure the efficient use of effort to communicate and manage their expectations.
- Assess how key stakeholders are likely to react or respond in various situations, in order to plan how to influence them to enhance their support and mitigate potential negative impacts.

There are multiple classification models used for stakeholders analysis, such as:

- *Power/interest grid*, grouping the stakeholders based on their level of authority (“power”) and their level of concern (“interest”) regarding the project outcomes;
- *Power/influence grid*, grouping the stakeholders based on their level of authority (“power”) and their active involvement (“influence”) in the project;
- *Influence/impact grid*, grouping the stakeholders based on their active involvement (“influence”) in the project and their ability to effect changes to the project’s planning or execution (“impact”); and
- *Salience model*, describing classes of stakeholders based on their power (ability to impose their will), urgency (need for immediate attention), and legitimacy (their involvement is appropriate).

Figure 13-4 presents an example of a power/interest grid with A-H representing the placement of generic stakeholders.

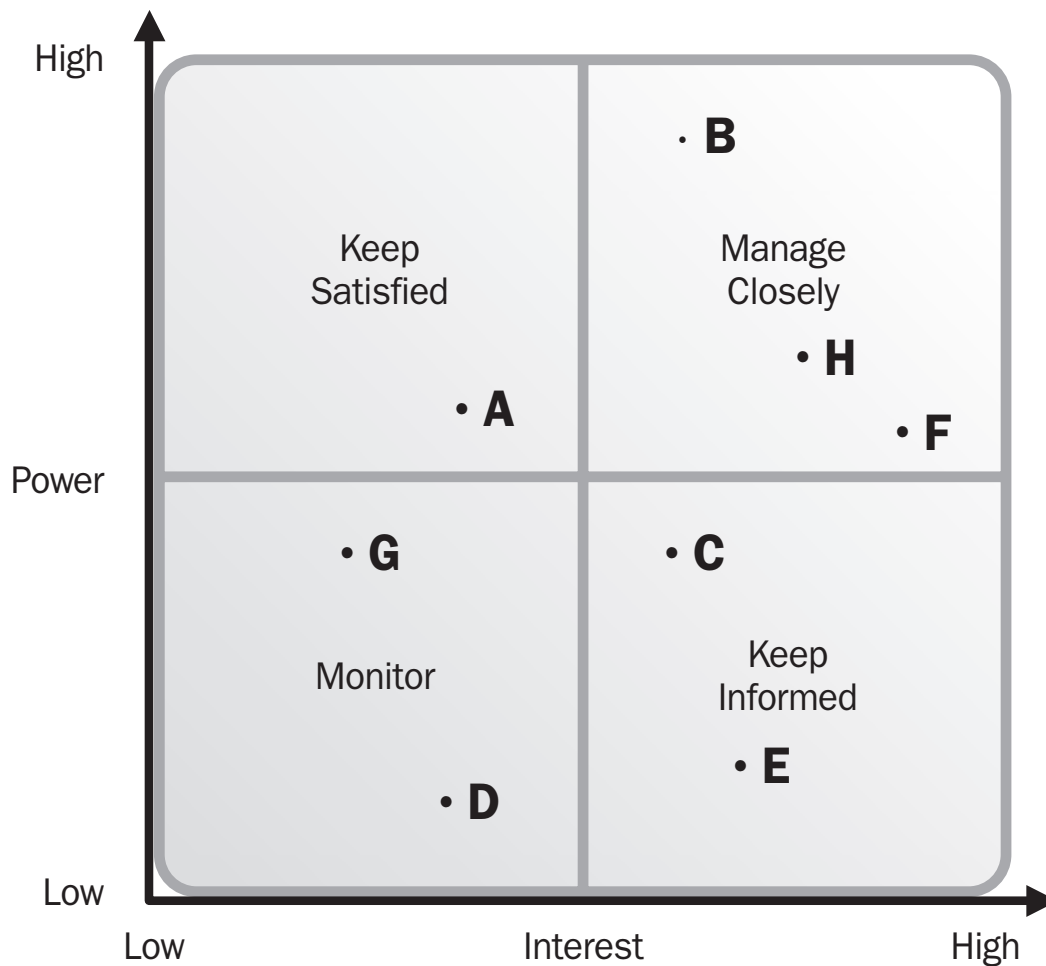

Figure 13-4. Example Power/Interest Grid with Stakeholders

13.1.2.2 Expert Judgment

To ensure comprehensive identification and listing of stakeholders, judgment and expertise should be sought from groups or individuals with specialized training or subject matter expertise, such as:

- Senior management;
- Other units within the organization;
- Identified key stakeholders;

- Project managers who have worked on projects in the same area (directly or through lessons learned);
- Subject matter experts (SMEs) in the business or project area;
- Industry groups and consultants; and
- Professional and technical associations, regulatory bodies, and nongovernmental organizations (NGOs).

Expert judgment can be obtained through individual consultations (one-on-one meetings, interviews, etc.) or through a panel format (focus groups, surveys, etc.).

13.1.2.3 Meetings

Profile analysis meetings are project meetings designed to develop an understanding of major project stakeholders, and they can be used to exchange and analyze information about roles, interests, knowledge, and the overall position of each stakeholder facing the project.

13.1.3 Identify Stakeholders: Outputs

13.1.3.1 Stakeholder Register

The main output of the Identify Stakeholders process is the stakeholder register. This contains all details related to the identified stakeholders including, but not limited to:

- **Identification information.** Name, organizational position, location, role in the project, contact information;
- **Assessment information.** Major requirements, main expectations, potential influence in the project, phase in the life cycle with the most interest; and
- **Stakeholder classification.** Internal/external, supporter/neutral/resistor, etc.

The stakeholder register should be consulted and updated on a regular basis, as stakeholders may change—or new ones identified—throughout the life cycle of the project.

13.2 Plan Stakeholder Management

Plan Stakeholder Management is the process of developing appropriate management strategies to effectively engage stakeholders throughout the project life cycle, based on the analysis of their needs, interests, and potential impact on project success. The key benefit of this process is that it provides a clear, actionable plan to interact with project stakeholders to support the project's interests. The inputs, tools and techniques, and outputs of this process are depicted in Figure 13-5. Figure 13-6 depicts the data flow diagram of the process.

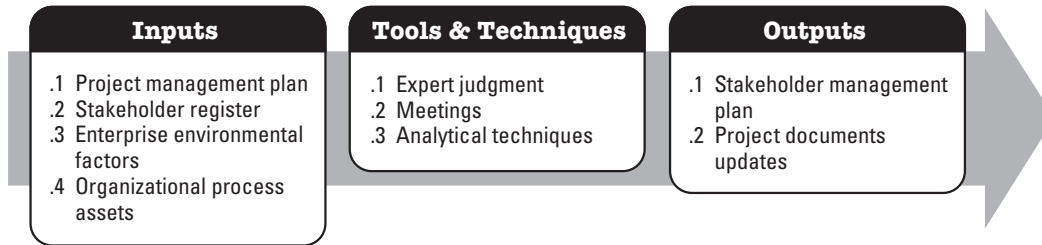

Figure 13-5. Plan Stakeholder Management: Inputs, Tools & Techniques, and Outputs

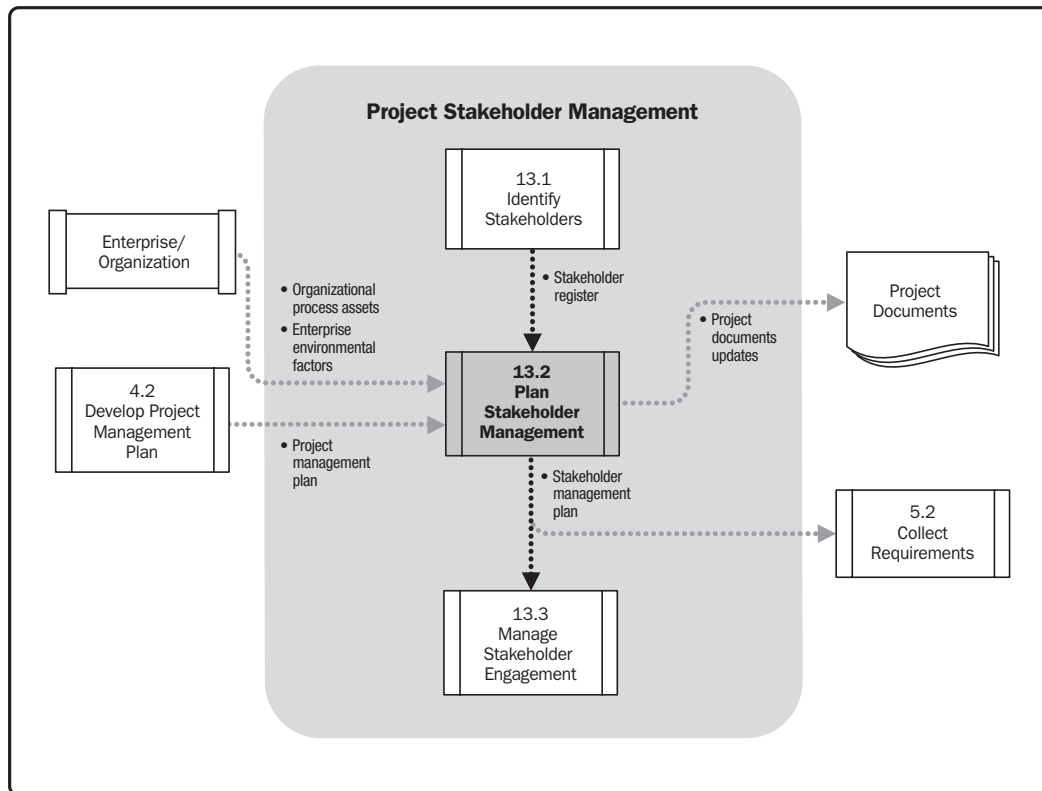

Figure 13-6. Plan Stakeholder Management Data Flow Diagram

Plan Stakeholder Management identifies how the project will affect stakeholders, which then allows the project manager to develop various ways to effectively engage stakeholders in the project, to manage their expectations, and to ultimately achieving the project objectives. Stakeholder management is more than improving communications and requires more than managing a team. Stakeholder management is about creation and maintenance of relationships between the project team and stakeholders, with the aim to satisfy their respective needs and requirements within project boundaries.

This process generates the stakeholder management plan, which contains detailed plans on how effective stakeholder management can be realized. As the project progresses, the membership of the stakeholder community and required level of engagement may change, therefore, stakeholder management planning is an iterative process that is reviewed on a regular basis by the project manager.

13.2.1 Plan Stakeholder Management: Inputs

13.2.1.1 Project Management Plan

Described in Section 4.2.3.1. The information used for the development of the stakeholder management plan includes, but is not limited to:

- Life cycle selected for the project and the processes that will be applied to each phase;
- Description of how work will be executed to accomplish the project objectives;
- Description of how human resources requirements will be met and how roles and responsibilities, reporting relationships, and staffing management will be addressed and structured for the project;
- Change management plan that documents how changes will be monitored and controlled; and
- Need and techniques for communication among stakeholders.

13.2.1.2 Stakeholder Register

Described in Section 13.1.3.1. The stakeholder register provides the information needed to plan appropriate ways to engage project stakeholders.

13.2.1.3 Enterprise Environmental Factors

Described in Section 2.1.5. All enterprise environmental factors are used as inputs to this process, because the management of stakeholders should be adapted to the project environment. Of these, organizational culture, structure, and political climate are of particular importance, because they help in determining the best options to support a better adaptive process for managing stakeholders.

13.2.1.4 Organizational Process Assets

Described in Section 2.1.4. All organizational process assets are used as inputs for the Plan Stakeholder Management process. Of these, lessons learned database and historical information are of particular importance, because they provide insights on previous stakeholder management plans and their effectiveness. These can be used to plan the stakeholder management activities for the current project.

13.2.2 Plan Stakeholder Management: Tools and Techniques

13.2.2.1 Expert Judgment

Based on the project objectives, the project manager should apply expert judgment to decide upon the level of engagement required at each stage of the project from each stakeholder. For example, at the beginning of a project, it may be necessary for senior stakeholders to be highly engaged in order to clear away any obstacles to success. Once these have been successfully removed, it may be sufficient for senior stakeholders to change their level of engagement from leading to supportive, and other stakeholders, such as end users, may become more important.

In order to create the stakeholder management plan, judgment and expertise should be sought from groups or individuals with specialized training or subject matter expertise or insight into the relationships within the organization, such as:

- Senior management;
- Project team members;
- Other units or individuals within the organization;
- Identified key stakeholders;

- Project managers who have worked on projects in the same area (directly or through lessons learned);
- Subject matter experts in business or project area;
- Industry groups and consultants; and
- Professional and technical associations, regulatory bodies, and nongovernmental organization (NGOs).

Expert judgment can be obtained through individual consultations (one-on-one meetings, interviews, etc.) or through a panel format (focus groups, surveys, etc.).

13.2.2.2 Meetings

Meetings should be held with experts and the project team to define the required engagement levels of all stakeholders. This information can be used to prepare the stakeholder management plan.

13.2.2.3 Analytical Techniques

The current engagement level of all stakeholders needs to be compared to the planned engagement levels required for successful project completion. Stakeholder engagement throughout the life cycle of the project is critical to project success.

The engagement level of the stakeholders can be classified as follows:

- **Unaware.** Unaware of project and potential impacts.
- **Resistant.** Aware of project and potential impacts and resistant to change.
- **Neutral.** Aware of project yet neither supportive nor resistant.
- **Supportive.** Aware of project and potential impacts and supportive to change.
- **Leading.** Aware of project and potential impacts and actively engaged in ensuring the project is a success.

The current engagement can be documented using Stakeholders Engagement Assessment Matrix, as shown in Figure 13-7, where C indicates the current engagement, and D indicates the desired engagement. The project team needs to identify the desired engagement level for the current phase of the project, based on available information.

The example in Figure 13-7 shows that stakeholder 3 is at the desired engagement level, while stakeholders 1 and 2 require further communications and additional actions to move them to the desired level of engagement.

Stakeholder	Unaware	Resistant	Neutral	Supportive	Leading
Stakeholder 1	C			D	
Stakeholder 2			C	D	
Stakeholder 3				D C	

Figure 13-7. Stakeholders Engagement Assessment Matrix

Through this analytical process, gaps between the current and desired engagement levels can be identified. Actions and communications required to close these gaps can be identified by the project team using expert judgment.

13.2.3 Plan Stakeholder Management: Outputs

13.2.3.1 Stakeholder Management Plan

The stakeholder management plan is a component of the project management plan (Section 4.2.3.1) and identifies the management strategies required to effectively engage stakeholders. The stakeholder management plan can be formal or informal, highly detailed or broadly framed, based on the needs of the project.

In addition to the data gathered in the stakeholder register, the stakeholder management plan often provides:

- Desired and current engagement levels of key stakeholders;
- Scope and impact of change to stakeholders;
- Identified interrelationships and potential overlap between stakeholders;
- Stakeholder communication requirements for the current project phase;
- Information to be distributed to stakeholders, including language, format, content, and level of detail;
- Reason for the distribution of that information and the expected impact to stakeholder engagement;
- Time frame and frequency for the distribution of required information to stakeholders; and
- Method for updating and refining the stakeholder management plan as the project progresses and develops.

Project managers should be aware of the sensitive nature of the stakeholder management plan and take appropriate precautions. For example, information on stakeholders who are resistant to the project can be potentially damaging, and due consideration should be given regarding the distribution of such information. When updating the stakeholder management plan, the validity of underlying assumptions should be reviewed to ensure continued accuracy and relevancy.

13.2.3.2 Project Documents Updates

Project documents that may be updated include, but are not limited to:

- Project schedule, and
- Stakeholder register.

13.3 Manage Stakeholder Engagement

Manage Stakeholder Engagement is the process of communicating and working with stakeholders to meet their needs/expectations, address issues as they occur, and foster appropriate stakeholder engagement in project activities throughout the project life cycle. The key benefit of this process is that it allows the project manager to increase support and minimize resistance from stakeholders, significantly increasing the chances to achieve project success. The inputs, tools and techniques, and outputs of this process are depicted in Figure 13-8. Figure 13-9 depicts the data flow diagram of the process.

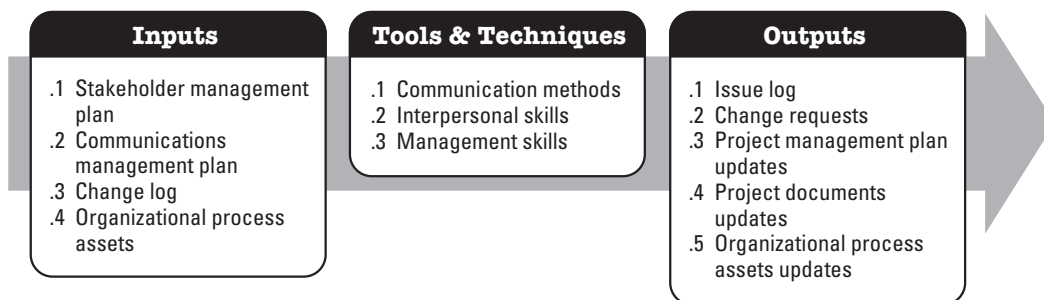

Figure 13-8. Manage Stakeholder Engagement: Inputs, Tools & Techniques, and Outputs

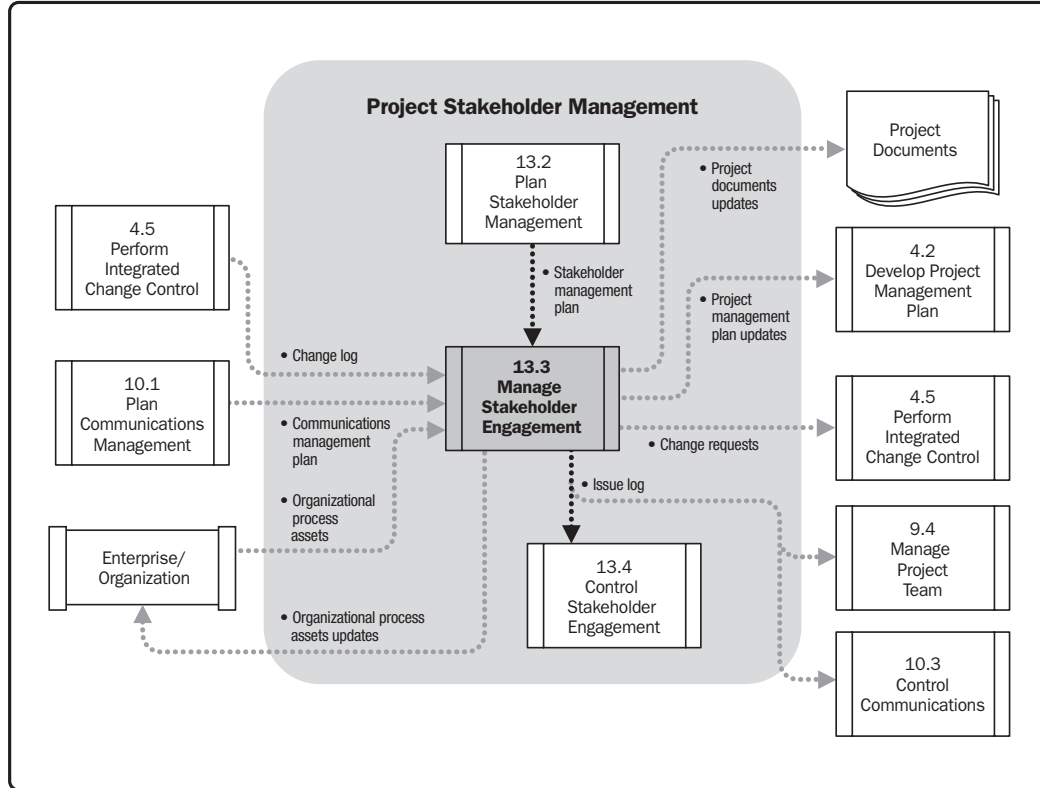

Figure 13-9. Manage Stakeholder Engagement Data Flow Diagram

Manage Stakeholder Engagement involves activities such as:

- Engaging stakeholders at appropriate project stages to obtain or confirm their continued commitment to the success of the project;
- Managing stakeholder expectations through negotiation and communication, ensuring project goals are achieved;
- Addressing potential concerns that have not yet become issues and anticipating future problems that may be raised by stakeholders. Such concerns need to be identified and discussed as soon as possible to assess associated project risks; and
- Clarifying and resolving issues that have been identified.

Managing stakeholder engagement helps to increase the probability of project success by ensuring that stakeholders clearly understand the project goals, objectives, benefits, and risks. This enables them to be active supporters of the project and to help guide activities and project decisions. By anticipating people's reactions to the project, proactive actions can be taken to win support or minimize negative impacts.

The ability of stakeholders to influence the project is typically highest during the initial stages and gets progressively lower as the project progresses. The project manager is responsible for engaging and managing the various stakeholders in a project and may call upon the project sponsor to assist as needed. Active management of stakeholder involvement decreases the risk of the project failing to meet its goals and objectives.

13.3.1 Manage Stakeholder Engagement: Inputs

13.3.1.1 Stakeholder Management Plan

Described in Section 13.2.3.1. The stakeholder management plan provides guidance on how the various stakeholders can be best involved in the project. The stakeholder management plan describes the methods and technologies used for stakeholder communication.

This plan is used to determine the level of interactions of various stakeholders and—together with other documents—helps define a strategy for identifying and managing stakeholders throughout the project life cycle.

13.3.1.2 Communications Management Plan

Described in Section 10.1.3.1. The communications management plan provides guidance and information on managing stakeholder expectations. The information used includes, but is not limited to:

- Stakeholder communications requirements;
- Information to be communicated, including language, format, content, and level of detail;
- Reason for distribution of information;
- Person or groups who will receive information; and
- Escalation process.

13.3.1.3 Change Log

Described in Section 4.5.3.2. A change log is used to document changes that occur during a project. These changes—and their impact on the project in terms of time, cost, and risk—are communicated to the appropriate stakeholders.

13.3.1.4 Organizational Process Assets

Described in Section 2.1.4. The organizational process assets that can influence the Manage Stakeholder Engagement process include, but are not limited to:

- Organizational communication requirements,
- Issue management procedures,
- Change control procedures, and
- Historical information about previous projects.

13.3.2 Manage Stakeholder Engagement: Tools and Techniques

13.3.2.1 Communication Methods

Described in Section 10.1.2.4. The methods of communication identified for each stakeholder in the communications management plan are utilized during stakeholder engagement management. Based on the stakeholders' communication requirements, the project manager decides how, when, and which of these communication methods are to be used in the project.

13.3.2.2 Interpersonal Skills

The project manager applies interpersonal skills to manage stakeholders' expectations. For example:

- Building trust,
- Resolving conflict,
- Active listening, and
- Overcoming resistance to change.

13.3.2.3 Management Skills

The project manager applies management skills to coordinate and harmonize the group toward accomplishing the project objectives. For example:

- Facilitate consensus toward project objectives,
- Influence people to support the project,
- Negotiate agreements to satisfy the project needs, and
- Modify organizational behavior to accept the project outcomes.

13.3.3 Manage Stakeholder Engagement: Outputs

13.3.3.1 Issue Log

Managing stakeholder engagement may result in the development of an issue log. This log is updated as new issues are identified and current issues are resolved.

13.3.3.2 Change Requests

Managing stakeholder engagement may result in a change request to the product or the project. It may also include corrective or preventive actions to the project itself or to the interaction with the impacted stakeholders, as appropriate.

13.3.3.3 Project Management Plan Updates

Elements of the project management plan that may be updated include, but are not limited to, the stakeholder management plan. This plan is updated when new or changed stakeholders requirements are identified. For example, some communications may no longer be necessary, an ineffective communication method may be replaced by another method, or a new communication requirement may be identified. It is also updated as a result of addressing concerns and resolving issues. For example, it may be determined that a stakeholder has additional informational needs.

13.3.3.4 Project Documents Updates

Project documents that may be updated include, but are not limited to, the stakeholder register. This is updated as information on stakeholders change, when new stakeholders are identified, or if registered stakeholders are no longer involved in or impacted by the project, or other updates for specific stakeholders are required.

13.3.3.5 Organizational Process Assets Updates

The organizational process assets that may be updated include, but are not limited to:

- **Stakeholder notifications.** Information may be provided to stakeholders about resolved issues, approved changes, and general project status.
- **Project reports.** Formal and informal project reports describe project status and include lessons learned, issue logs, project closure reports, and outputs from other Knowledge Areas (Sections 4-12).
- **Project presentations.** Information formally or informally provided by the project team to any or all project stakeholders.
- **Project records.** Project records include correspondence, memos, meeting minutes, and other documents describing the project.
- **Feedback from stakeholders.** Information received from stakeholders concerning project operations can be distributed and used to modify or improve future performance of the project.
- **Lessons learned documentation.** Documentation includes the root cause analysis of issues faced, reasoning behind the corrective action chosen, and other types of lessons learned about stakeholder management. Lessons learned are documented and distributed, and become part of the historical database for both the project and the performing organization.

13.4 Control Stakeholder Engagement

Control Stakeholder Engagement is the process of monitoring overall project stakeholder relationships and adjusting strategies and plans for engaging stakeholders. The key benefit of this process is that it will maintain or increase the efficiency and effectiveness of stakeholder engagement activities as the project evolves and its environment changes. The inputs, tools and techniques, and outputs of this process are depicted in Figure 13-10. Figure 13-11 depicts the data flow diagram of the process.

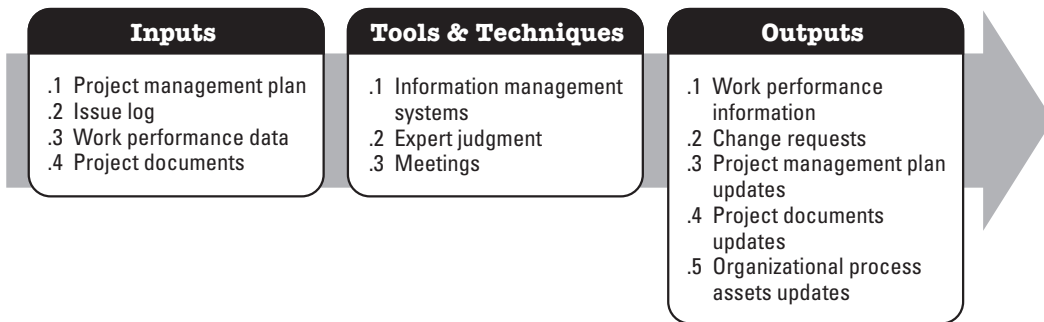

Figure 13-10. Control Stakeholder Engagement: Inputs, Tools & Techniques, and Outputs

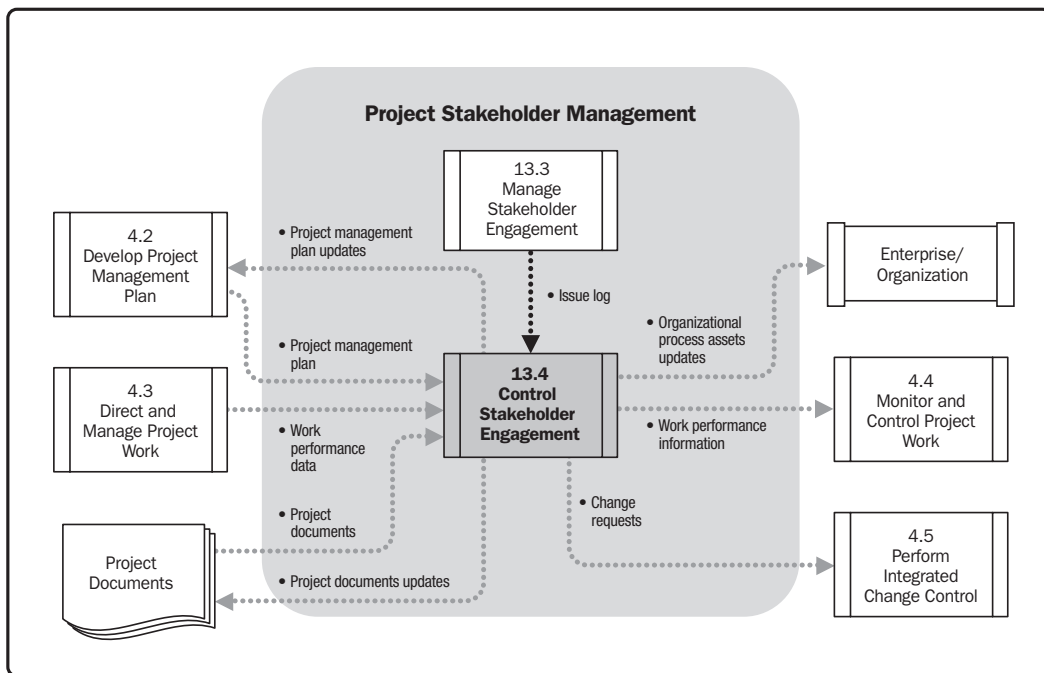

Figure 13-11. Control Stakeholder Engagement: Data Flow Diagram

Stakeholder engagement activities are included in the stakeholder management plan and are executed during the life cycle of the project. Stakeholder engagement should be continuously controlled.

13.4.1 Control Stakeholder Engagement: Inputs

13.4.1.1 Project Management Plan

Described in Section 4.2.3.1. The project management plan is used to develop the stakeholder management plan, as described in Section 13.1.3.1. The information used to Control Stakeholder Engagement includes, but is not limited to:

- The life cycle selected for the project and the processes that will be applied to each phase;
- How work will be executed to accomplish the project objectives;
- How human resources requirements will be met, how roles and responsibilities, reporting relationships, and staffing management will be addressed and structured for the project;
- A change management plan that documents how changes will be monitored and controlled; and
- Needs and techniques for communication among stakeholders.

13.4.1.2 Issue Log

Described in Section 13.3.3.1. The issue log is updated as new issues are identified and current issues are resolved.

13.4.1.3 Work Performance Data

Described in Section 4.3.3.2. The work performance data are the primary observations and measurements identified during activities being performed to carry out the project work. Various measurements on project activities and deliverables are collected during various controlling processes. Data are often viewed as the lowest level of abstraction from which information is derived by other processes.

Examples of work performance data include reported percentage of work completed, technical performance measures, start and finish dates of schedule activities, number of change requests, number of defects, actual costs, actual durations etc.

13.4.1.4 Project Documents

Multiple project documents originating from initiation, planning, execution, or control processes may be used as supporting inputs for controlling stakeholder engagement. These include, but are not limited to:

- Project schedule,
- Stakeholder register,
- Issue log,
- Change log, and
- Project communications.

13.4.2 Control Stakeholder Engagement: Tools and Techniques

13.4.2.1 Information Management Systems

An information management system provides a standard tool for the project manager to capture, store, and distribute information to stakeholders about the project cost, schedule progress, and performance. It also allows the project manager to consolidate reports from several systems and facilitate report distribution to the project stakeholders. Examples of distribution formats may include table reporting, spreadsheet analysis, and presentations. Graphical capabilities can be used to create visual representations of project performance information.

13.4.2.2 Expert Judgment

To ensure comprehensive identification and listing of new stakeholders, reassessment of current stakeholders can be performed. Input should be sought from groups or individuals with specialized training or subject matter expertise, such as:

- Senior management;
- Other units or individuals within the organization;
- Identified key stakeholders;
- Project managers who have worked on projects in the same area (directly or through lessons learned);
- Subject matter experts in the business or project area;
- Industry groups and consultants; and
- Professional and technical associations, regulatory bodies, and nongovernmental organizations.

Expert judgment can be obtained through individual consultations (such as one-on-one meetings or interviews) or through a panel format (such as focus groups or surveys).

13.4.2.3 Meetings

Status review meetings are used to exchange and analyze information about stakeholder engagement.

13.4.3 Control Stakeholder Engagement: Outputs

13.4.3.1 Work Performance Information

The work performance information is the performance data collected from various controlling processes, analyzed in context, and integrated based on relationships across areas. Thus work performance data have been transformed into work performance information. Data per se are not used in the decision-making process, because the meaning may be misinterpreted. Information, however, is correlated and contextualized and provides a sound foundation for project decisions.

Work performance information is circulated through communication processes. Examples of performance information are status of deliverables, implementation status for change requests, and forecasted estimates to complete.

13.4.3.2 Change Requests

Analysis of project performance and interactions with stakeholders often generates change requests. These change requests are processed through the Perform Integrated Change Control process (Section 4.5) as follows:

- Recommended corrective actions include changes that bring the expected future performance of the project in line with the project management plan; and
- Recommended preventive actions can reduce the probability of incurring future negative project performance.

13.4.3.3 Project Management Plan Updates

As stakeholders engage with the project the overall effectiveness of the stakeholder management strategy can be evaluated. As needed changes in approach or strategy are identified, affected sections of the project management plan may need to be updated to reflect these changes. Elements of the project management plan that may be updated include, but are not limited to the:

- Change management plan,
- Communications management plan,
- Cost management plan,
- Human resource management plan,
- Procurement management plan,
- Quality management plan,
- Requirements management plan,
- Risk management plan,
- Schedule management plan,
- Scope management plan, and
- Stakeholder management plan.

13.4.3.4 Project Documents Updates

Project documents that may be updated include, but are not limited to:

- **Stakeholder register.** This is updated as information on stakeholders change, when new stakeholders are identified, or if registered stakeholders are no longer involved in or impacted by the project, or other updates for specific stakeholders are required.
- **Issue log.** This is updated as new issues are identified and current issues are resolved.

13.4.3.5 Organizational Process Assets Updates

The organizational process assets, which may be updated include, but are not limited to:

- **Stakeholder notifications.** Information may be provided to stakeholders about resolved issues, approved changes, and general project status.
- **Project reports.** Formal and informal project reports describe project status and include lessons learned, issue logs, project closure reports, and outputs from other Knowledge Areas (Sections 4-12).
- **Project presentations.** Information formally or informally provided by the project team to any or all project stakeholders.
- **Project records.** Project records include correspondence, memos, meeting minutes, and other documents describing the project.
- **Feedback from stakeholders.** Information received from stakeholders concerning project operations can be distributed and used to modify or improve future performance of the project.
- **Lessons learned documentation.** Documentation includes the root cause analysis of issues faced, reasoning behind the corrective action chosen, and other types of lessons learned about stakeholder management. Lessons learned are documented and distributed so that they become part of the historical database for both the project and the performing organization.

ANNEX A1

THE STANDARD FOR PROJECT MANAGEMENT OF A PROJECT

A project is a temporary endeavor undertaken to create a unique product, service, or result. The temporary nature of projects indicates a definite beginning and end. The end is reached when the project's objectives have been achieved or when the project is terminated because its objectives will not or cannot be met, or when the need for the project no longer exists.

Project management is the application of knowledge, skills, tools, and techniques to project activities to meet project requirements. Project management is accomplished through the appropriate application and integration of logically grouped project management processes.

Managing a project typically includes:

- Identifying requirements;
- Addressing the various needs, concerns, and expectations of the stakeholders as the project is planned and carried out;
- Setting and maintaining active communication with stakeholders; and
- Balancing the competing project constraints, which include, but are not limited to:
 - Scope,
 - Quality,
 - Schedule,
 - Budget,
 - Resources, and
 - Risks.

The specific project circumstances will influence the constraints on which the project manager needs to focus and require effective application and management of appropriate project management processes.

A1.1 What is a Standard?

The International Organization for Standardization (ISO) and others define a standard as a “*Document approved by a recognized body, that provides, for common and repeated use, rules, guidelines, or characteristics for products, processes or services with which compliance are not mandatory.*” (ISO 9453) [11]

In October 1998, PMI was accredited as a standards developer by the American National Standards Institute (ANSI). The processes outlined in this Annex, which are described in the *PMBOK® Guide – Fifth Edition*, provide the standard for project management of a project.

A1.2 Framework for this Standard

This standard describes the nature of project management processes in terms of the integration between the processes, their interactions, and the purposes they serve. For this standard, it is assumed that the project, the project manager and the project team are assigned to the performing organization. Project management processes are grouped into five categories known as Project Management Process Groups (or Process Groups):

- **Initiating Process Group.** Those processes performed to define a new project or a new phase of an existing project by obtaining authorization to start the project or phase.
- **Planning Process Group.** Those processes required to establish the scope of the project, refine the objectives, and define the course of action required to attain the objectives that the project was undertaken to achieve.
- **Executing Process Group.** Those processes performed to complete the work defined in the project management plan to satisfy the project specifications.
- **Monitoring and Controlling Process Group.** Those processes required to track, review, and regulate the progress and performance of the project; identify any areas in which changes to the plan are required; and initiate the corresponding changes.
- **Closing Process Group.** Those processes performed to finalize all activities across all Process Groups to formally close the project or phase.

Project Management Process Groups are linked by the outputs they produce. The Process Groups are seldom either discrete or one-time events; they are overlapping activities that occur throughout the project. The output of one process generally becomes an input to another process or is a deliverable of the project, subproject, or project phase. Deliverables at the subproject or project level may be called incremental deliverables. The Planning Process Group provides the Executing Process Group with the project management plan and project documents, and, as the project progresses, it often creates updates to the project management plan and the project documents. Figure A1-1 illustrates how the Process Groups interact and shows the level of overlap at various times. If the project is divided into phases, the Process Groups interact within each phase.

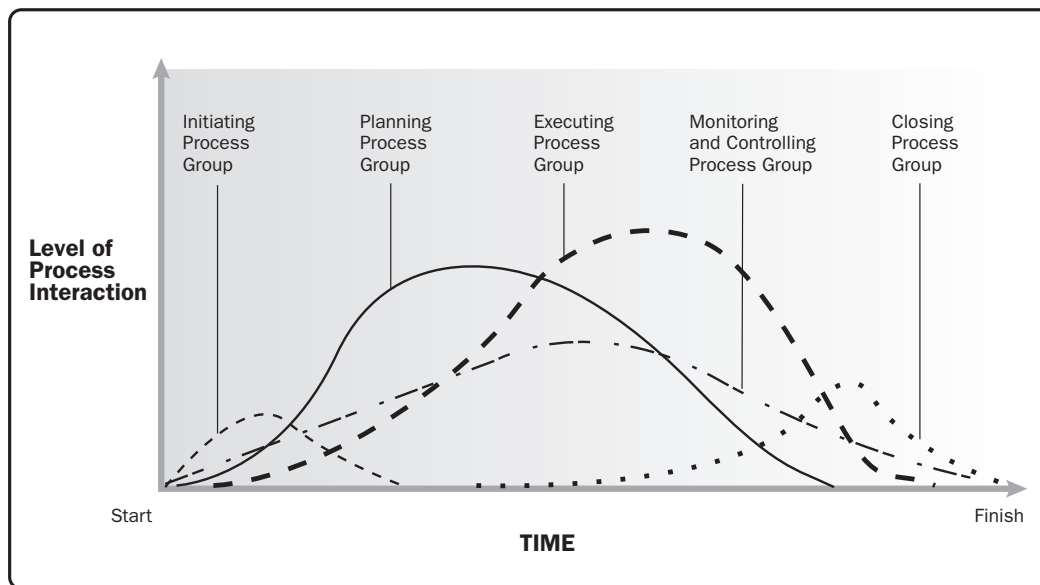

Figure A1-1. Process Group Interactions in a Project

An example of this interaction would be the exit of a design phase, which requires sponsor acceptance of the design document. Once it is available, the design document provides the product description for the Planning and Executing Process Groups in one or more subsequent phases. When a project is divided into phases, the Process Groups are carried out, as appropriate, to effectively drive the project to completion in a controlled manner. In multiphase projects, processes are repeated within each phase until the criteria for phase completion have been satisfied.

A1.3 Project Management Process Groups

The following sections identify and describe the five Project Management Process Groups required for any project. These five Process Groups have clear dependencies and are typically performed in each project and highly interact with one another. These five Process Groups are independent of application areas or industry focus. Individual Process Groups and individual processes are often iterated prior to completing the project and can have interactions within a Process Group and among Process Groups. The nature of these interactions varies from project to project and may or may not be performed in a particular order.

The process flow diagram, Figure A1-2, provides an overall summary of the basic flow and interactions among Process Groups and specific stakeholders. The project management processes are linked by inputs and outputs where the result or outcome of one process becomes the input to another process but not necessarily in the same Process Group. **The Process Groups are not project phases.** In fact, it is possible that all Process Groups could be conducted within a phase. As projects are separated into distinct phases or subcomponents, such as concept development, feasibility study, design, prototype, build, or test, etc., all of the Process Groups would normally be repeated for each phase or subcomponent along the lines explained above and illustrated in Figure A1-2.

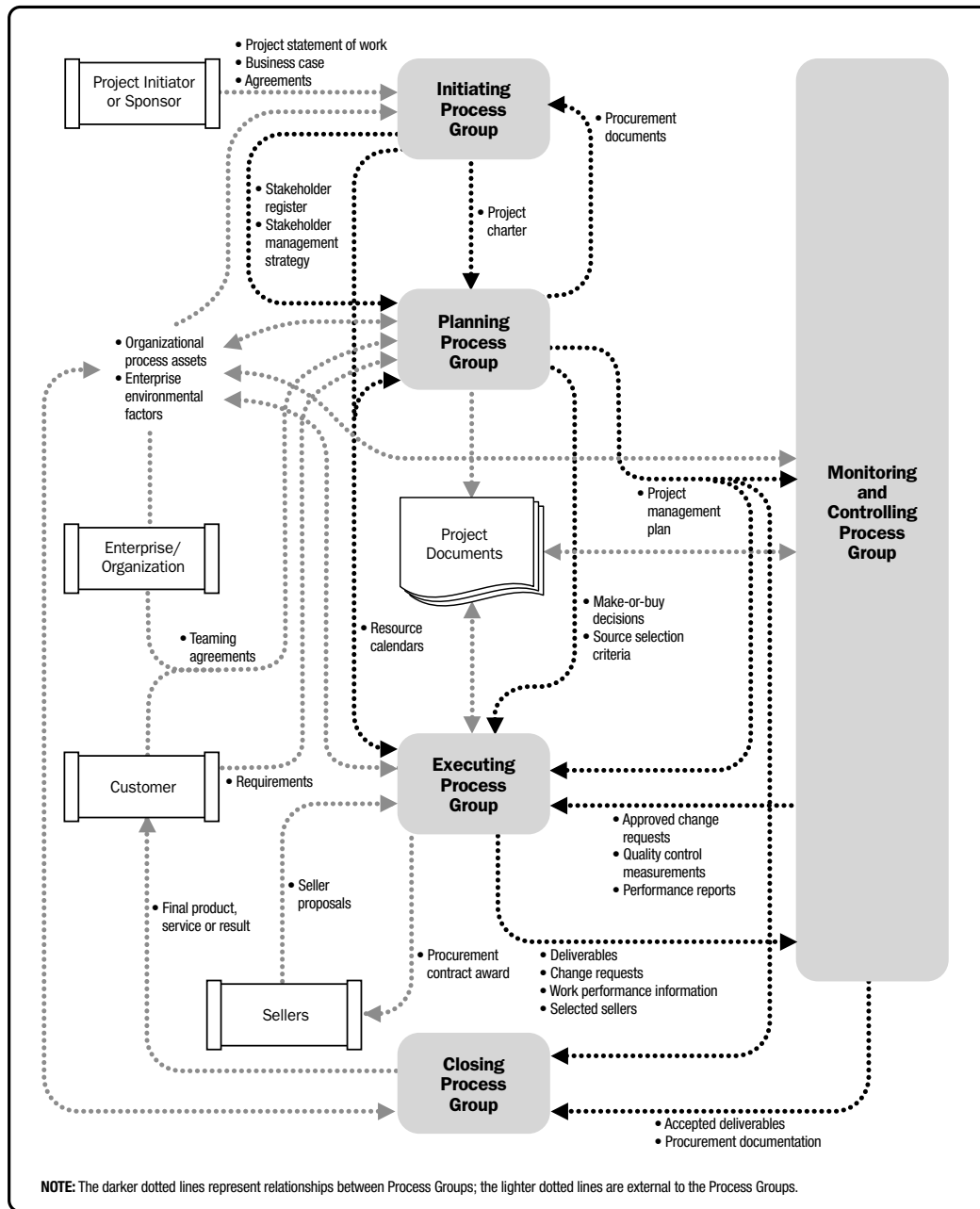

Figure A1-2. Project Management Process Interactions

Table A1-1 reflects the mapping of the 47 project management processes into the 5 Project Management Process Groups and the 10 Project Management Knowledge Areas.

The project management processes are shown in the Process Group in which most of the activity takes place. For example, when a process that normally takes place in the Planning Process Group is updated in the Executing Process Group, it is not considered a new process. The iterative nature of project management means that processes from any group may be used throughout the project life cycle. For example, executing a risk response may trigger the Perform Quantitative Risk Analysis process to evaluate the impact.

Table A1-1. Project Management Process Group and Knowledge Area Mapping

Knowledge Areas	Project Management Process Groups				
	Initiating Process Group	Planning Process Group	Executing Process Group	Monitoring and Controlling Process Group	Closing Process Group
4. Project Integration Management	4.1 Develop Project Charter	4.2 Develop Project Management Plan	4.3 Direct and Manage Project Work	4.4 Monitor and Control Project Work 4.5 Perform Integrated Change Control	4.6 Close Project or Phase
5. Project Scope Management		5.1 Plan Scope Management 5.2 Collect Requirements 5.3 Define Scope 5.4 Create WBS		5.5 Validate Scope 5.6 Control Scope	
6. Project Time Management		6.1 Plan Schedule Management 6.2 Define Activities 6.3 Sequence Activities 6.4 Estimate Activity Resources 6.5 Estimate Activity Durations 6.6 Develop Schedule		6.7 Control Schedule	
7. Project Cost Management		7.1 Plan Cost Management 7.2 Estimate Costs 7.3 Determine Budget		7.4 Control Costs	
8. Project Quality Management		8.1 Plan Quality Management	8.2 Perform Quality Assurance	8.3 Control Quality	
9. Project Human Resource Management		9.1 Plan Human Resource Management	9.2 Acquire Project Team 9.3 Develop Project Team 9.4 Manage Project Team		
10. Project Communications Management		10.1 Plan Communications Management	10.2 Manage Communications	10.3 Control Communications	
11. Project Risk Management		11.1 Plan Risk Management 11.2 Identify Risks 11.3 Perform Qualitative Risk Analysis 11.4 Perform Quantitative Risk Analysis 11.5 Plan Risk Responses		11.6 Control Risks	
12. Project Procurement Management		12.1 Plan Procurement Management	12.2 Conduct Procurements	12.3 Control Procurements	12.4 Close Procurements
13. Project Stakeholder Management	13.1 Identify Stakeholders	13.2 Plan Stakeholder Management	13.3 Manage Stakeholder Engagement	13.4 Control Stakeholder Engagement	

A1.4 Initiating Process Group

The Initiating Process Group consists of those processes performed to define a new project or a new phase of an existing project by obtaining authorization to start the project or phase. Within the Initiating processes, the initial scope is defined and initial financial resources are committed. Internal and external stakeholders who will interact and influence the overall outcome of the project are identified. If not already assigned, the project manager will be selected. This information is captured in the project charter and stakeholder register. When the project charter is approved, the project becomes officially authorized. Although the project management team may help to write the project charter, this standard assumes that business case assessment, approval, and funding are handled external to the project boundaries (Figure A1-3). A project boundary is defined as the point in time that a project or project phase is authorized to its completion. The key purpose of this Process Group is to align the stakeholders' expectations with the project's purpose, give them visibility about the scope and objectives, and show how their participation in the project and its associated phases can ensure that their expectations are achieved. These processes help to set the vision of the project—what is needed to be accomplished.

Large complex projects should be divided into separate phases. In such projects, the Initiating processes are carried out during subsequent phases to validate the decisions made during the original Develop Project Charter and Identify Stakeholders processes. Performing the Initiating processes at the start of each phase helps to keep the project focused on the business need that the project was undertaken to address. The success criteria are verified, and the influence, drivers, and objectives of the project stakeholders are reviewed. A decision is then made as to whether the project should be continued, delayed, or discontinued.

Involving the sponsors, customers, and other stakeholders during initiation creates a shared understanding of success criteria, reduces the overhead of involvement, and generally improves deliverable acceptance, customer, and other stakeholder satisfaction.

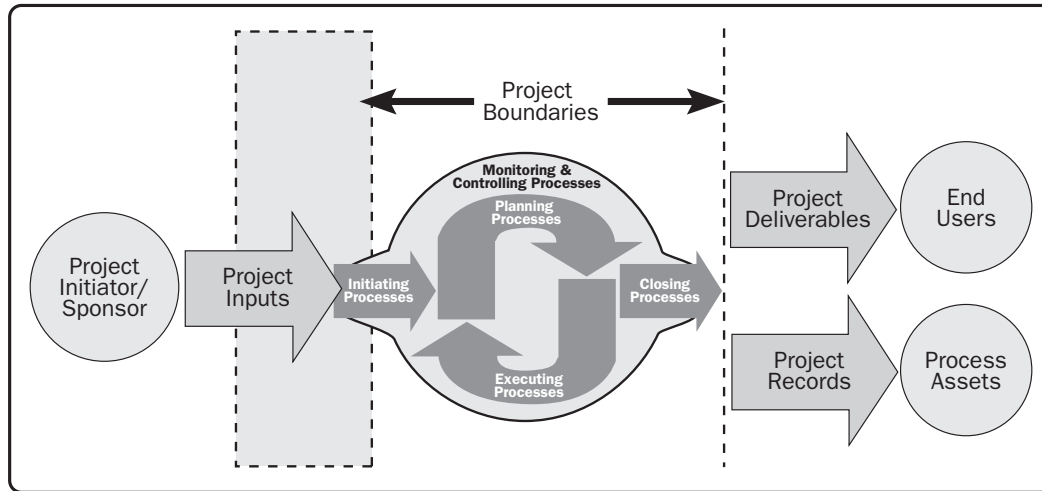

Figure A1-3. Project Boundaries

Initiating processes may be performed at the organizational, program, or portfolio level and would then be outside of the project’s level of control. For example, prior to commencing a project, the need for high-level requirements may be documented as part of a larger organizational initiative. A process of evaluating alternatives may be utilized to determine the feasibility of the new undertaking. Clear descriptions of the project objectives may be developed, including the reasons why a specific project is the best alternative to satisfy the requirements. The documentation for this decision may also contain the initial project scope statement, deliverables, project duration, and a forecast of the resources for the organization’s investment analysis. As part of the Initiating processes, the project manager is given the authority to apply organizational resources to the subsequent project activities.

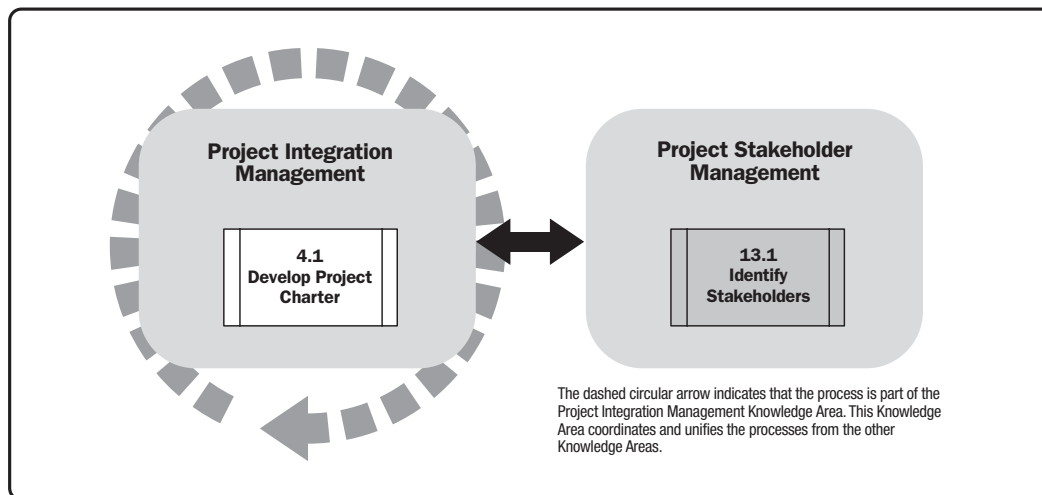

Figure A1-4. Initiating Process Group

A1.4.1 Develop Project Charter

Develop Project Charter is the process of developing a document that formally authorizes the existence of a project and provides the project manager with the authority to apply organizational resources to project activities. The key benefit of this process is a well-defined project start and project boundaries, creation of a formal record of the project, and a direct way for senior management to formally accept and commit to the project. The inputs and outputs for this process are shown in Figure A1-5.

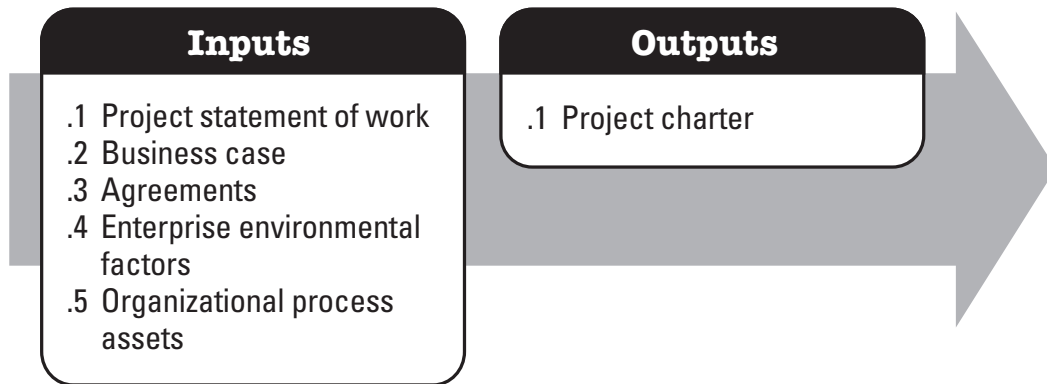

Figure A1-5. Develop Project Charter: Inputs and Outputs

A1.4.2 Identify Stakeholders

Identify Stakeholders is the process of identifying the people, groups, or organizations that could impact or be impacted by a decision, activity, or outcome of the project; and analyzing and documenting relevant information regarding their interests, involvement, interdependencies, influence, and potential impact on project success. The key benefit of this process is that it allows the project manager to identify the appropriate focus for each stakeholder or group of stakeholders. The inputs and outputs of this process are depicted in Figure A1-6.

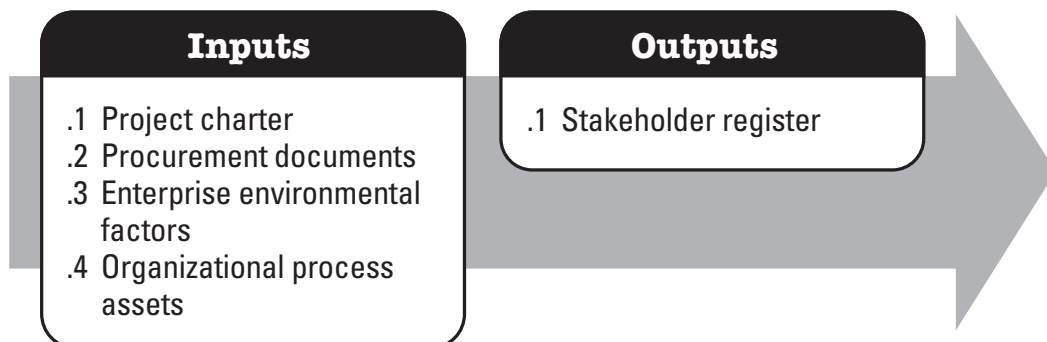

Figure A1-6. Identify Stakeholders: Inputs and Outputs

A1.5 Planning Process Group

The Planning Process Group consists of those processes performed to establish the total scope of the effort, define and refine the objectives, and develop the course of action required to attain those objectives. The Planning processes develop the project management plan and the project documents that will be used to carry out the project. The complex nature of project management may require the use of repeated feedback loops for additional analysis. As more project information or characteristics are gathered and understood, additional planning will likely be required. Significant changes occurring throughout the project life cycle trigger a need to revisit one or more of the planning processes and, possibly, some of the initiating processes. This progressive detailing of the project management plan is called progressive elaboration, indicating that planning and documentation are iterative and ongoing activities. The key benefit of this Process Group is to delineate the strategy and tactics as well as the course of action or a path to successfully complete the project or phase. When the Planning Process Group is well managed, it is much easier to get stakeholder buy-in and engagement. These processes describe how this will be done, resulting in the desired objectives.

The project management plan and project documents developed as outputs from the Planning Process Group will explore all aspects of the scope, time, costs, quality, communications, human resources, risks, procurements, and stakeholder management.

Updates arising from approved changes during the project (generally during Monitoring and Controlling processes and specifically during Direct and Manage Project Work process) may significantly impact parts of the project management plan and the project documents. Updates to these documents provide greater precision with respect to schedule, costs, and resource requirements to meet the defined project scope.

The project team seeks input and encourages involvement from all stakeholders when planning the project and developing the project management plan and project documents. Since the feedback and refinement process cannot continue indefinitely, procedures set by the organization dictate when the initial planning effort ends. These procedures will be affected by the nature of the project, the established project boundaries, appropriate monitoring and controlling activities, as well as the environment in which the project will be performed.

Other interactions among the processes within the Planning Process Group are dependent upon the nature of the project. For example, for some projects there will be little or no identifiable risks until after significant planning has been done. At that time, the team might recognize that the cost and schedule targets are overly aggressive, thus involving considerably more risk than previously understood. The results of the iterations are documented as updates to the project management plan or to various project documents.

The Planning Process Group (Figure A1-7) includes the project management processes identified in Figures A1-8 through A1-31 (see Sections A1.5.1 through A1.5.24).

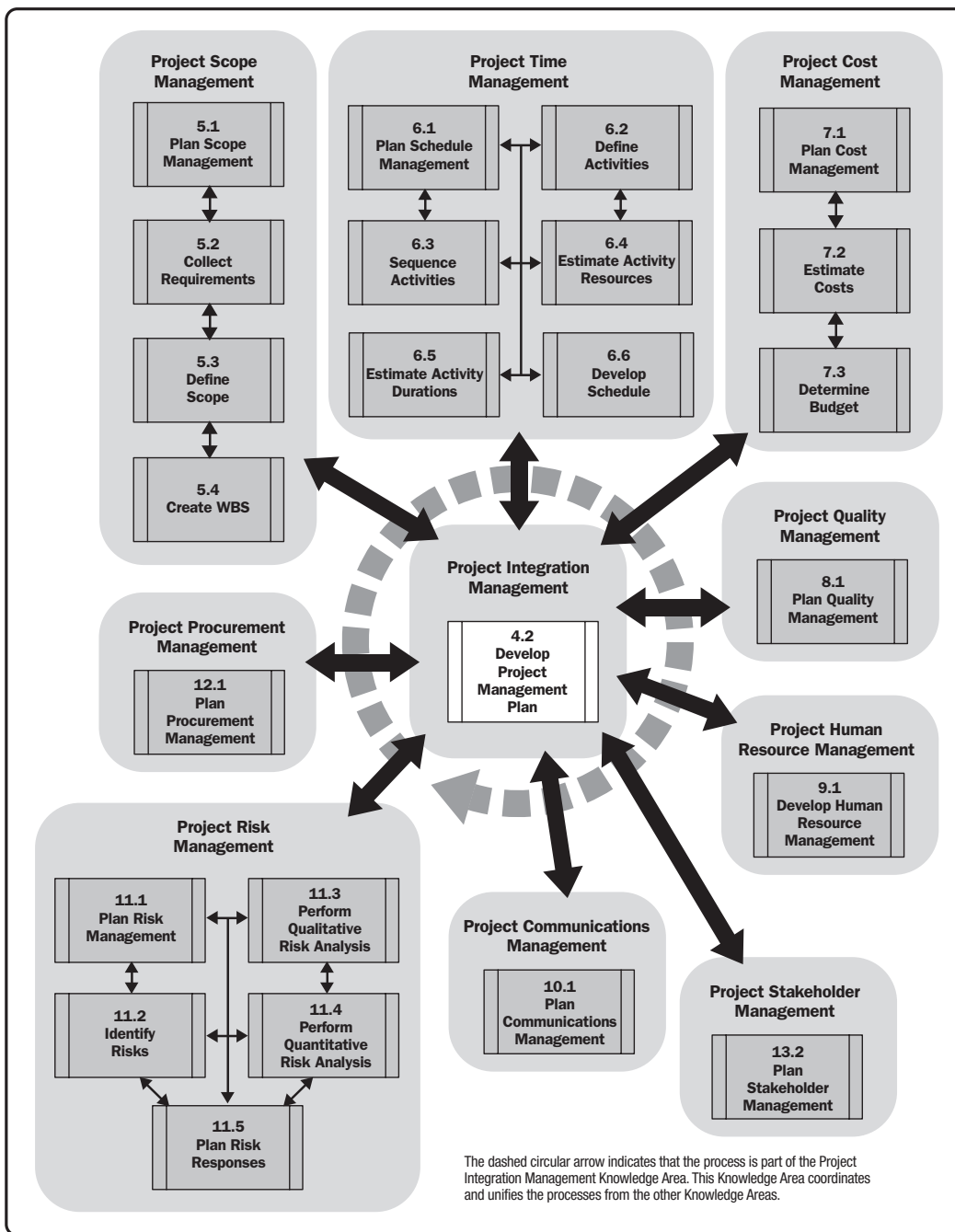

Figure A1-7. Planning Process Group

A1.5.1 Develop Project Management Plan

Develop Project Management Plan is the process of defining, preparing, and coordinating all subsidiary plans and integrating them into a comprehensive project management plan. The key benefit of this process is a central document that defines the basis of all project work. The inputs and outputs for this process are depicted in Figure A1-8.

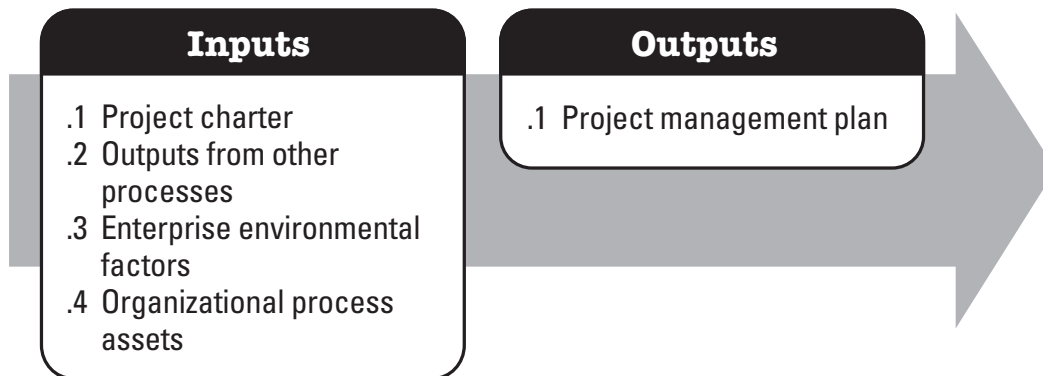

Figure A1-8. Develop Project Management Plan: Inputs and Outputs

A1.5.2 Plan Scope Management

Plan Scope Management is the process of creating a scope management plan that documents how the project scope will be defined, validated, and controlled. The key benefit of this process is that it provides guidance and direction on how scope will be managed throughout the project. The inputs and outputs of this process are depicted in Figure A1-9.

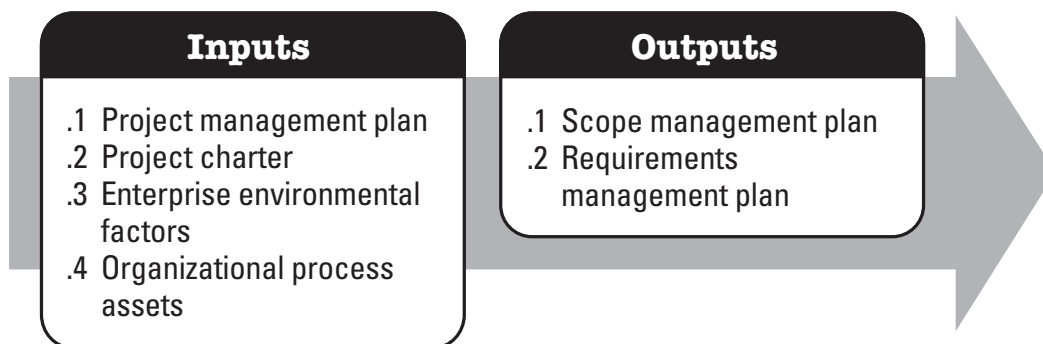

Figure A1-9. Plan Scope Management: Inputs and Outputs

A1.5.3 Collect Requirements

Collect Requirements is the process of determining, documenting, and managing stakeholder needs and requirements to meet project objectives. The key benefit of this process is that it provides the basis for defining and managing the project scope including product scope. The inputs and outputs of this process are depicted in Figure A1-10.

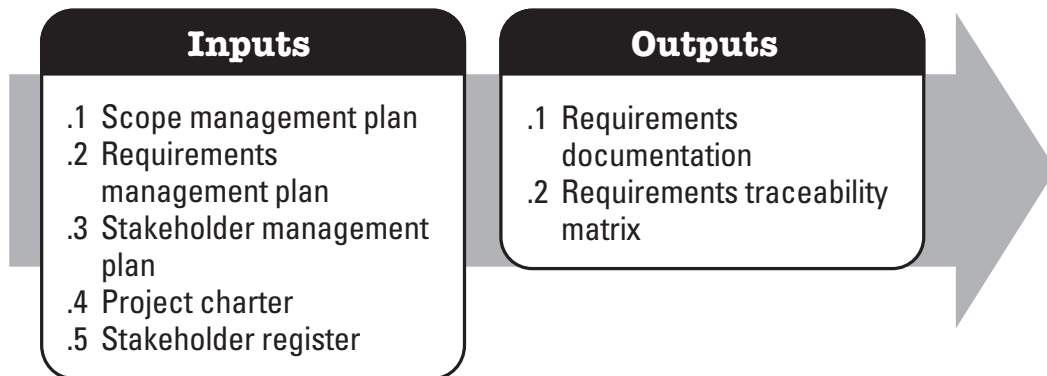

Figure A1-10. Collect Requirements: Inputs and Outputs

A1.5.4 Define Scope

Define Scope is the process of developing a detailed description of the project and product. The key benefit of this process is that it describes the project, service, or result boundaries by defining which of the requirements collected will be included in and excluded from the project scope. The inputs and outputs of this process are depicted in Figure A1-11.

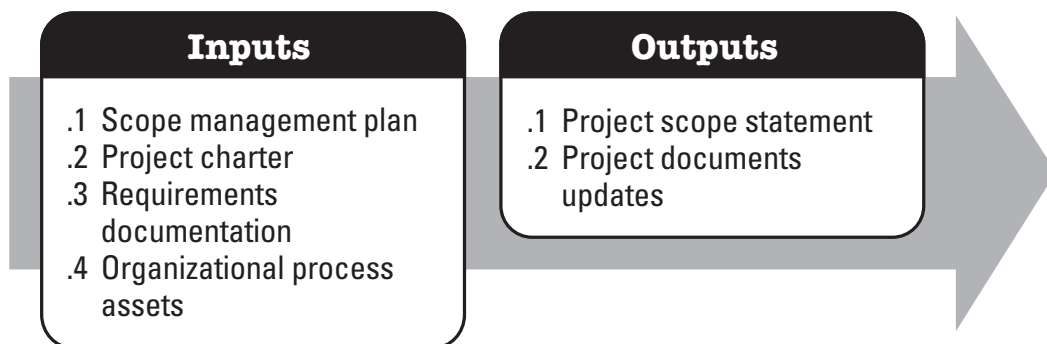

Figure A1-11. Define Scope: Inputs and Outputs

A1.5.5 Create WBS

Create WBS is the process of subdividing project deliverables and project work into smaller, more manageable components. The key benefit of this process is that it provides a structured vision of what has to be delivered. The inputs and outputs of this process are depicted in Figure A1-12.

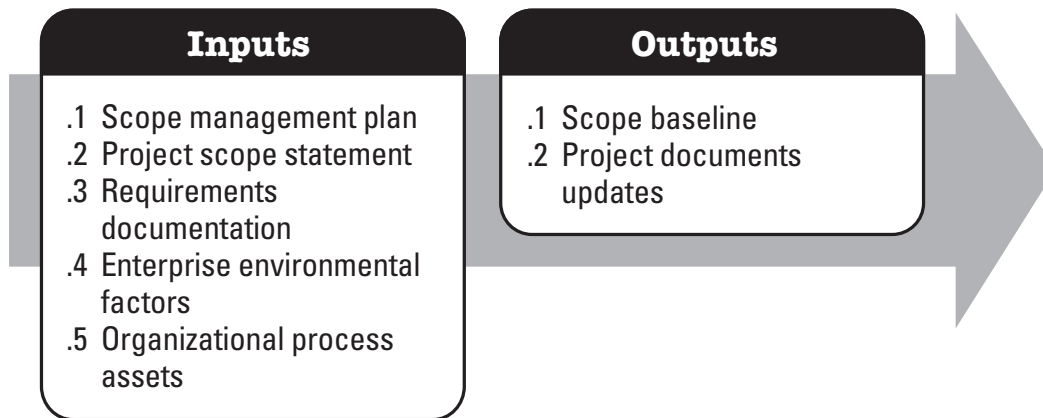

Figure A1-12. Create WBS: Inputs and Outputs

A1.5.6 Plan Schedule Management

Plan Schedule Management is the process of establishing the policies, procedures, and documentation for planning, developing, managing, executing, and controlling the project schedule. The key benefit of this process is that it provides guidance and direction on how the project schedule will be managed throughout the project. The inputs and outputs of this process are depicted in Figure A1-13.

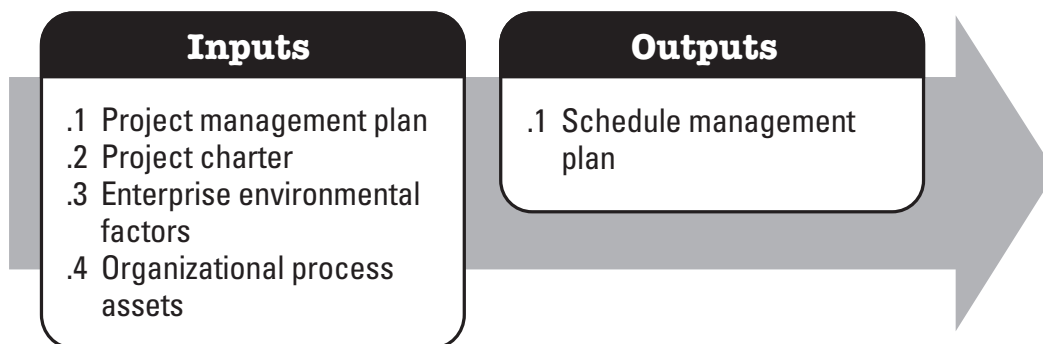

Figure A1-13. Plan Schedule Management: Inputs and Outputs

A1.5.7 Define Activities

Define Activities is the process of identifying and documenting the specific actions to be performed to produce the project deliverables. The key benefit of this process is to break down work packages into activities that provide a basis for estimating, scheduling, executing, monitoring, and controlling the project work. The inputs and outputs of this process are depicted in Figure A1-14.

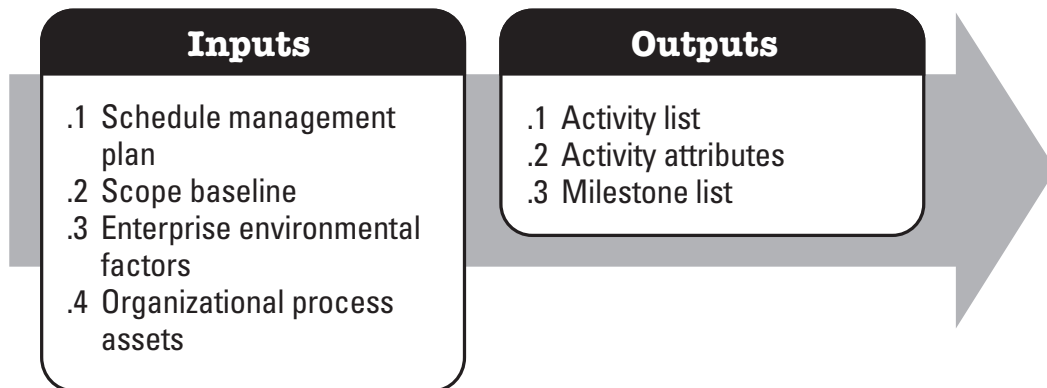

Figure A1-14. Define Activities: Inputs and Outputs

A1.5.8 Sequence Activities

Sequence Activities is the process of identifying and documenting relationships among the project activities. The key benefit of this process is that it defines the logical sequence of work to obtain the greatest efficiency given all project constraints. The inputs and outputs of this process are depicted in Figure A1-15.

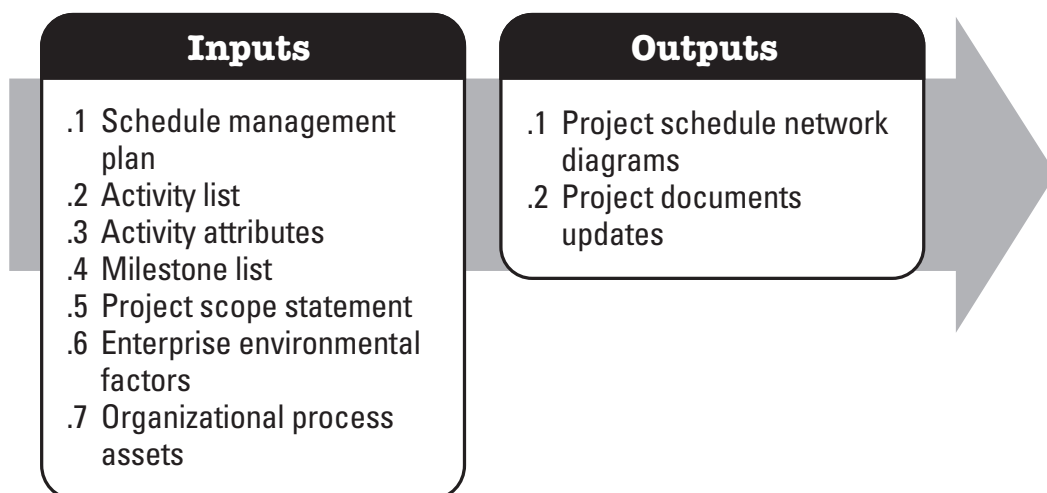

Figure A1-15. Sequence Activities: Inputs and Outputs

A1.5.9 Estimate Activity Resources

Estimate Activity Resources is the process of estimating the type and quantities of material, human resources, equipment, or supplies required to perform each activity. The key benefit of this process is that it identifies the type, quantity, and characteristics of resources required to complete the activity which allows more accurate cost and duration estimates. The inputs and outputs of this process are depicted in Figure A1-16.

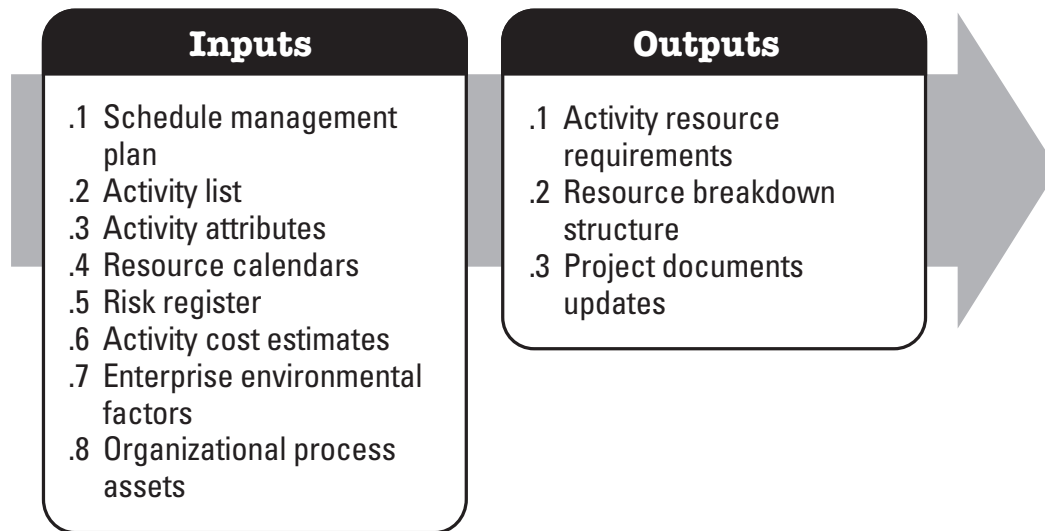

Figure A1-16. Estimate Activity Resources: Inputs and Outputs

A1.5.10 Estimate Activity Durations

Estimate Activity Durations is the process of estimating the number of work periods needed to complete individual activities with estimated resources. The key benefit of this process is that it provides the amount of time each activity will take to complete, which is a major input into the Develop Schedule process. The inputs and outputs of this process are depicted in Figure A1-17.

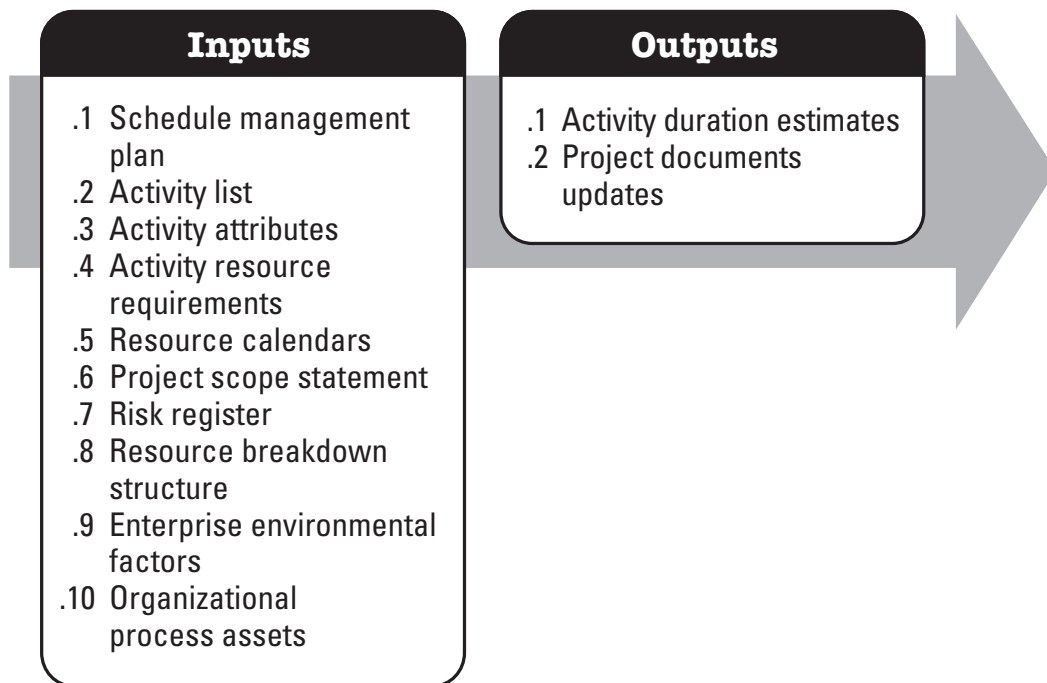

Figure A1-17. Estimate Activity Durations: Inputs and Outputs

A1.5.11 Develop Schedule

Develop Schedule is the process of analyzing activity sequences, durations, resource requirements, and schedule constraints to create the project schedule model. The key benefit of this process is that by entering schedule activities, durations, resources, resource availabilities, and logical relationships into the scheduling tool, it generates a schedule model with planned dates for completing project activities. The inputs and outputs of this process are depicted in Figure A1-18.

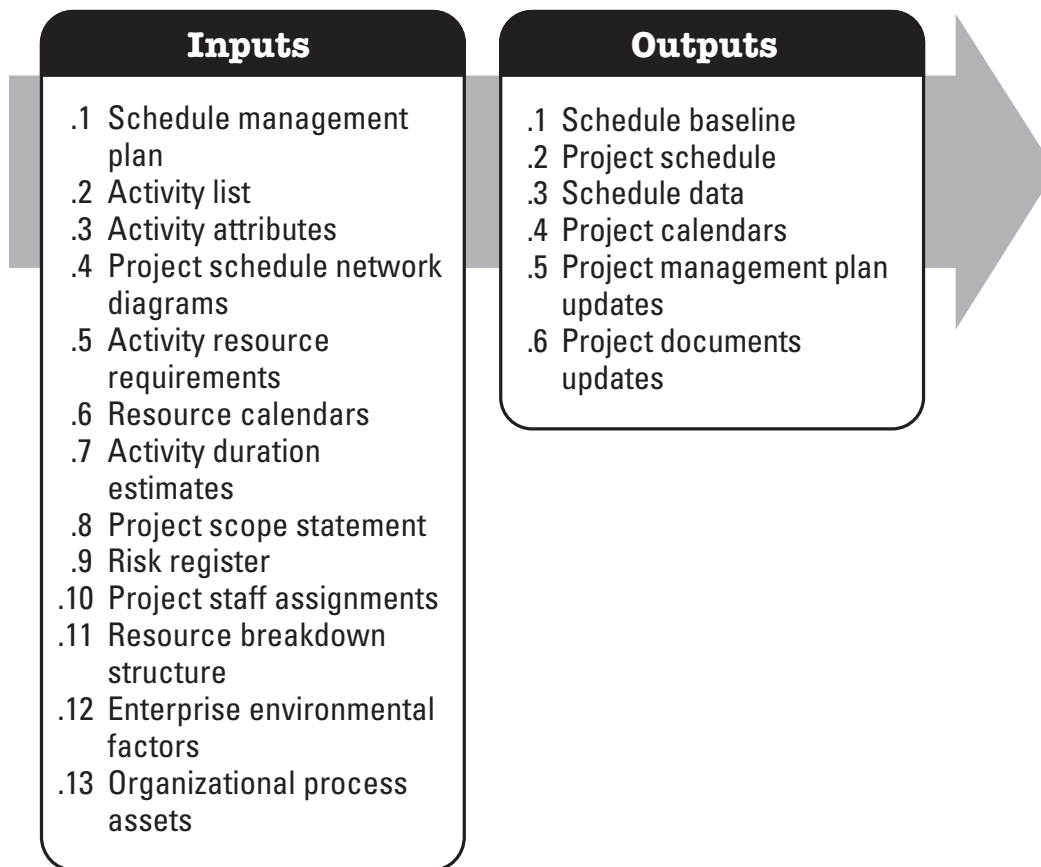

Figure A1-18. Develop Schedule: Inputs and Outputs

A1.5.12 Plan Cost Management

Plan Cost Management is the process that establishes the policies, procedures, and documentation for planning, managing, expending, and controlling project costs. The key benefit of this process is that it provides guidance and direction on how the project costs will be managed throughout the project. The inputs and outputs of this process are depicted in Figure A1-19.

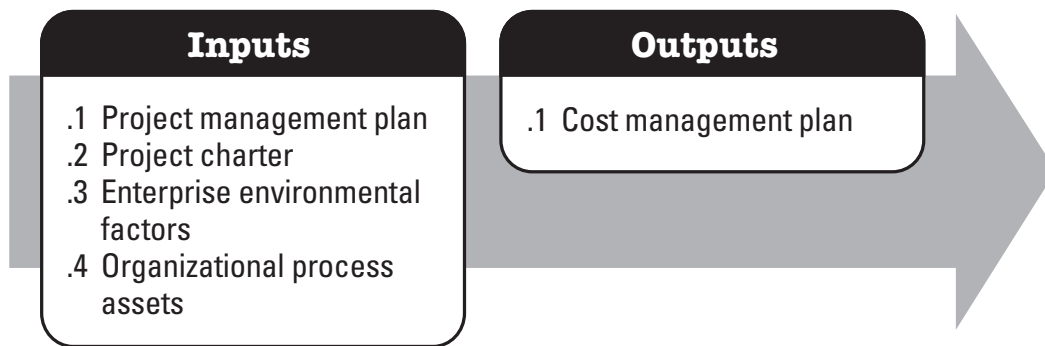

Figure A1-19. Plan Cost Management: Inputs and Outputs

A1.5.13 Estimate Costs

Estimate Costs is the process of developing an approximation of the monetary resources needed to complete project activities. The key benefit of this process is that it determines the amount of cost required to complete project work. The inputs and outputs of this process are depicted in Figure A1-20.

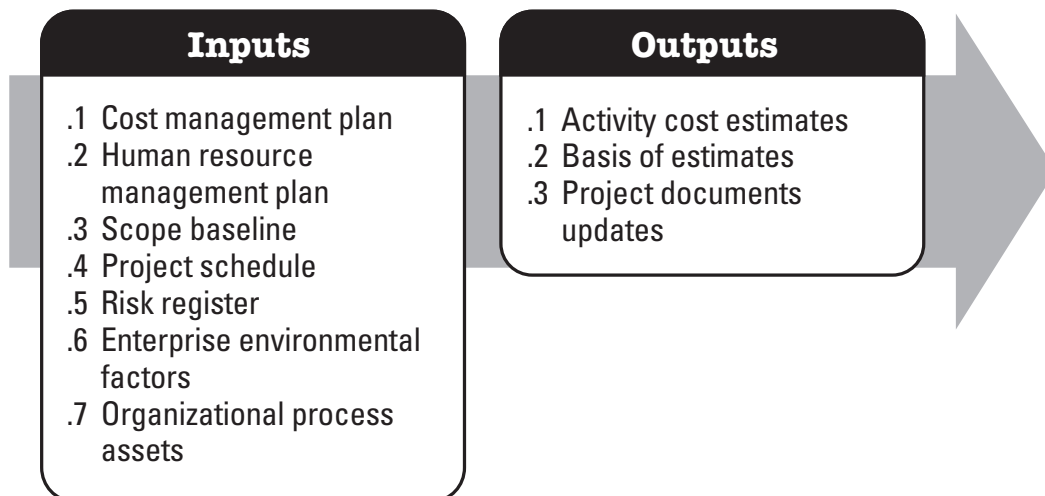

Figure A1-20. Estimate Costs: Inputs and Outputs

A1.5.14 Determine Budget

Determine Budget is the process of aggregating the estimated costs of individual activities or work packages to establish an authorized cost baseline. The key benefit of this process is that it determines the cost baseline against which project performance can be monitored and controlled. The inputs and outputs of this process are depicted in Figure A1-21.

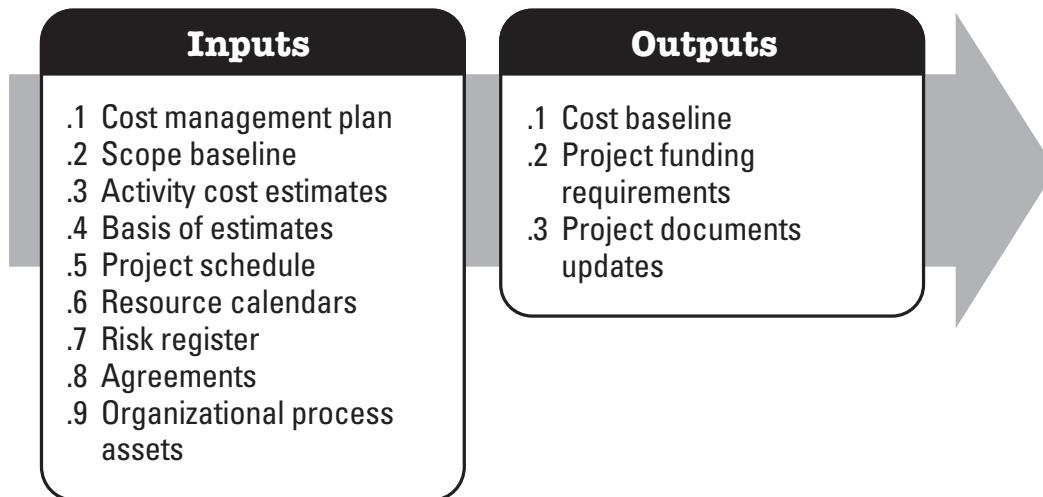

Figure A1-21. Determine Budget: Inputs and Outputs

A1.5.15 Plan Quality Management

Plan Quality Management is the process of identifying quality requirements and/or standards for the project and its deliverables, and documenting how the project will demonstrate compliance with relevant quality requirements. The key benefit of this process is that it provides guidance and direction on how quality will be managed and validated throughout the project. The input and outputs of this process are depicted in Figure A1-22.

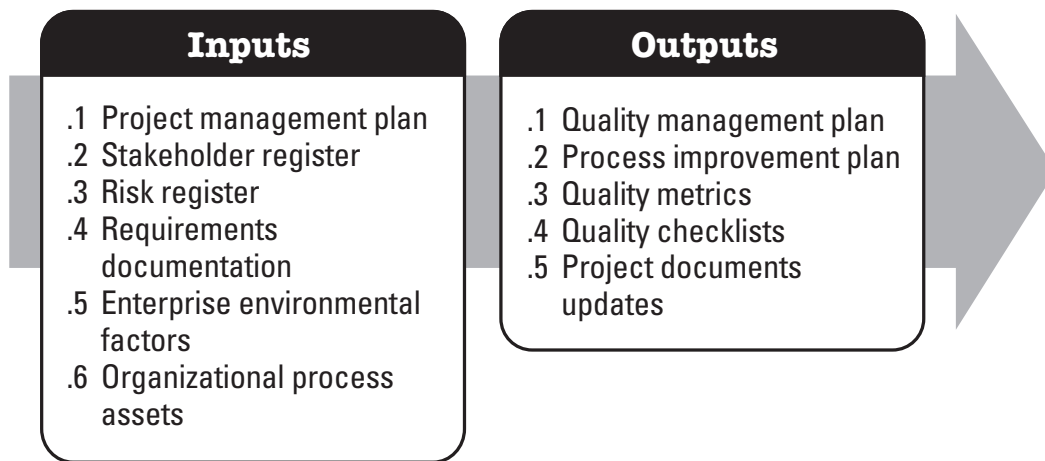

Figure A1-22. Plan Quality Management: Inputs and Outputs

A1.5.16 Plan Human Resource Management

Plan Human Resource Management is the process of identifying and documenting project roles, responsibilities, required skills, reporting relationships, and creating a staffing management plan. The key benefit of this process is that it establishes project roles and responsibilities, project organization charts, and the staffing management plan including the timetable for staff acquisition and release. The input and outputs of this process are depicted in Figure A1-23.

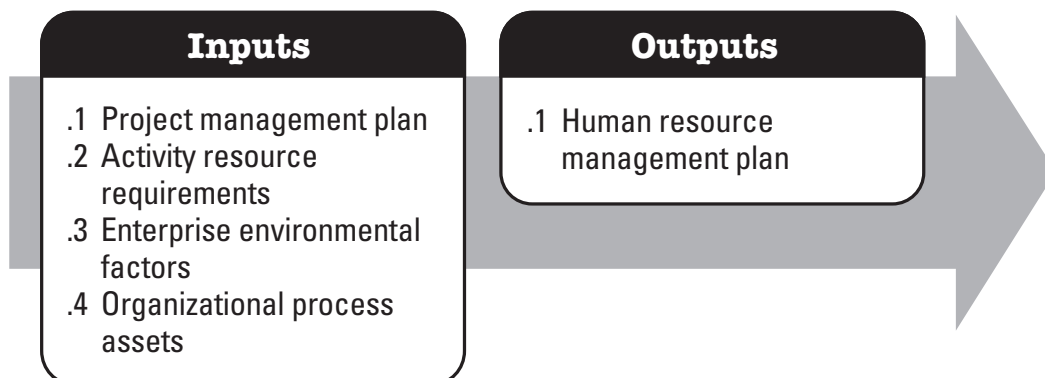

Figure A1-23. Plan Human Resource Management: Inputs and Outputs

A1.5.17 Plan Communications Management

Plan Communications Management is the process of developing an appropriate approach and plan for project communications based on stakeholder's information needs and requirements, and available organizational assets. The key benefit of this process is that it identifies and documents the approach to communicate most effectively and efficiently with stakeholders. The inputs and outputs of this process are depicted in Figure A1-24.

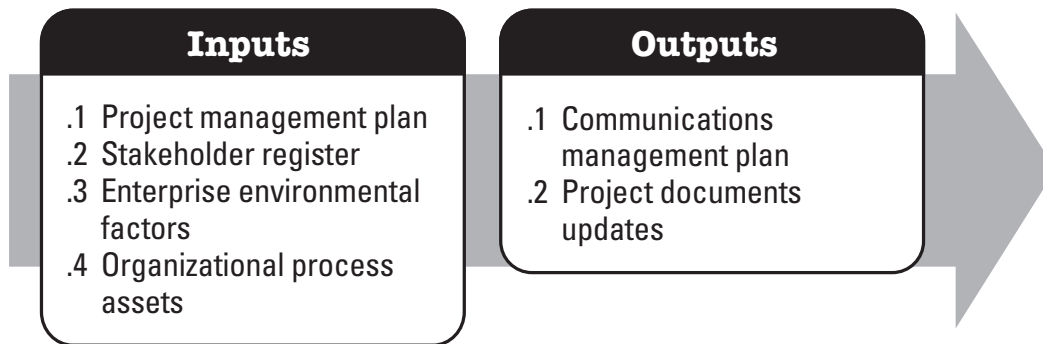

Figure A1-24. Plan Communications Management: Inputs and Outputs

A1.5.18 Plan Risk Management

Plan Risk Management is the process of defining how to conduct risk management activities for a project. The key benefit of this process is that it ensures that the degree, type, and visibility of risk management are commensurate with both the risks and the importance of the project to the organization. The input and outputs of this process are depicted in Figure A1-25.

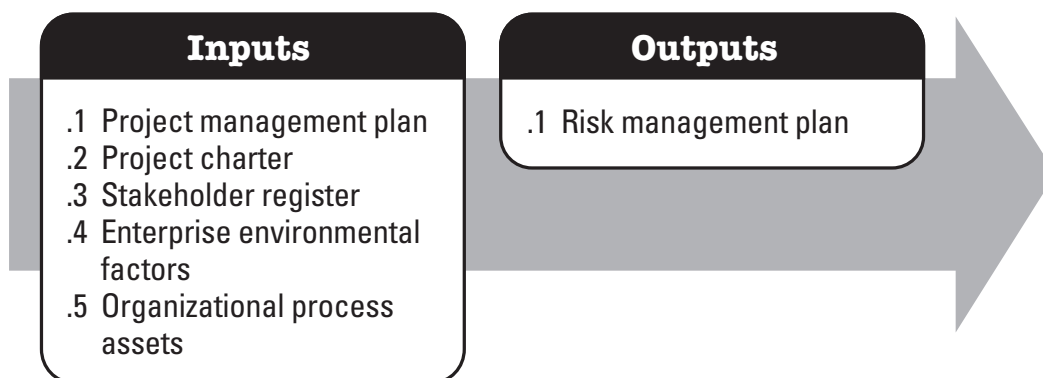

Figure A1-25. Plan Risk Management: Inputs and Outputs

A1.5.19 Identify Risks

Identify Risks is the process of determining which risks may affect the project and documenting their characteristics. The key benefit of this process is the documentation of existing risks and the knowledge and ability it provides to the project team to anticipate events. The inputs and outputs of this process are depicted in Figure A1-26.

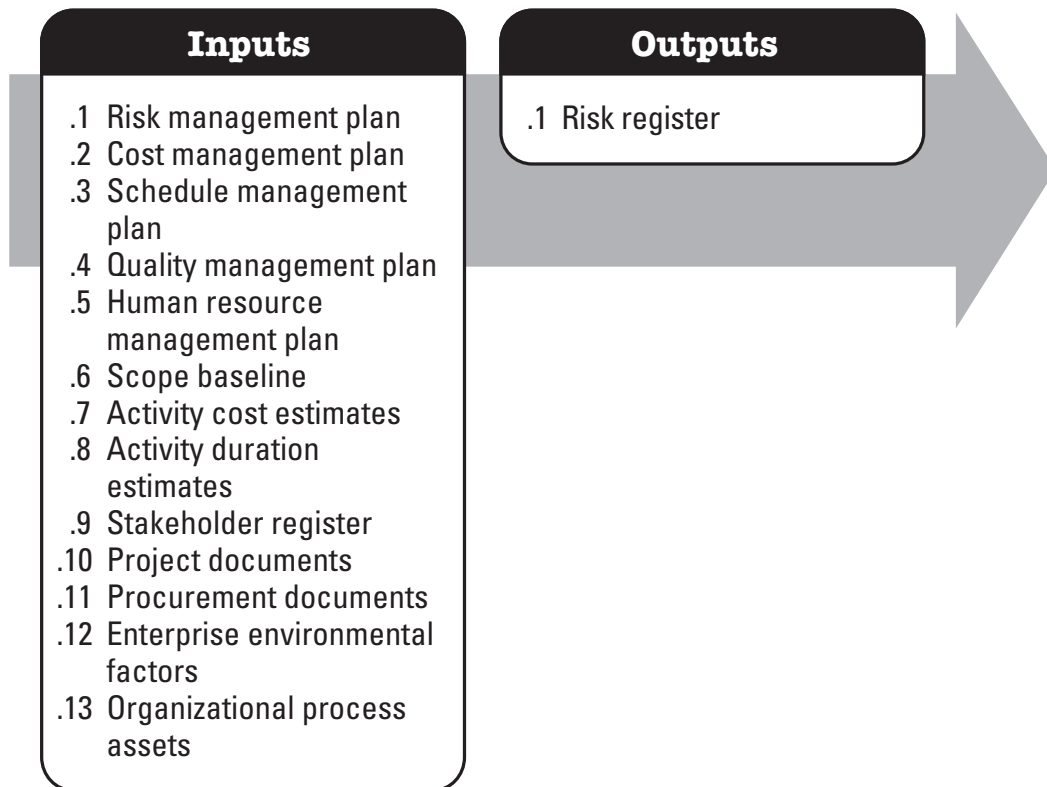

Figure A1-26. Identify Risks: Inputs and Outputs

A1.5.20 Perform Qualitative Risk Analysis

Perform Qualitative Risk Analysis is the process of prioritizing risks for further analysis or action by assessing and combining their probability of occurrence and impact. The key benefit of this process is that it enables project managers to reduce the level of uncertainty and to focus on high-priority risks. The inputs and outputs of this process are depicted in Figure A1-27.

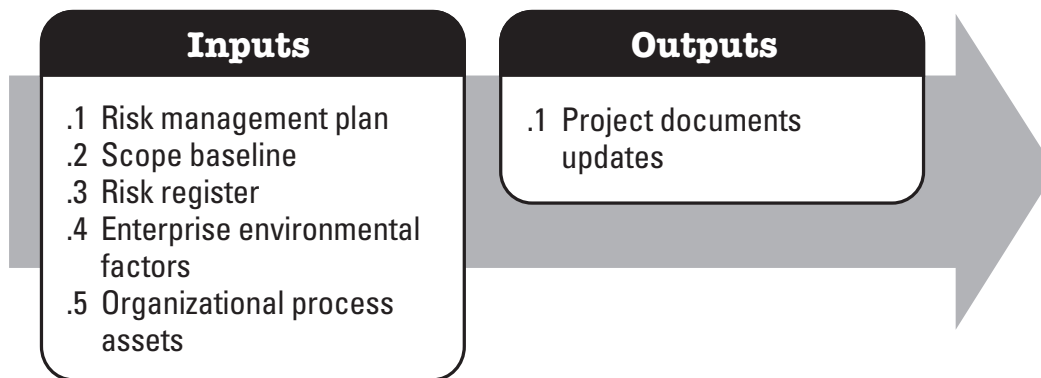

Figure A1-27. Perform Qualitative Risk Analysis: Inputs and Outputs

A1.5.21 Perform Quantitative Risk Analysis

Perform Quantitative Risk Analysis is the process of numerically analyzing the effect of identified risks on overall project objectives. The key benefit of this process is that it produces quantitative risk information to support decision making in order to reduce project uncertainty. The inputs and outputs of this process are depicted in Figure A1-28.

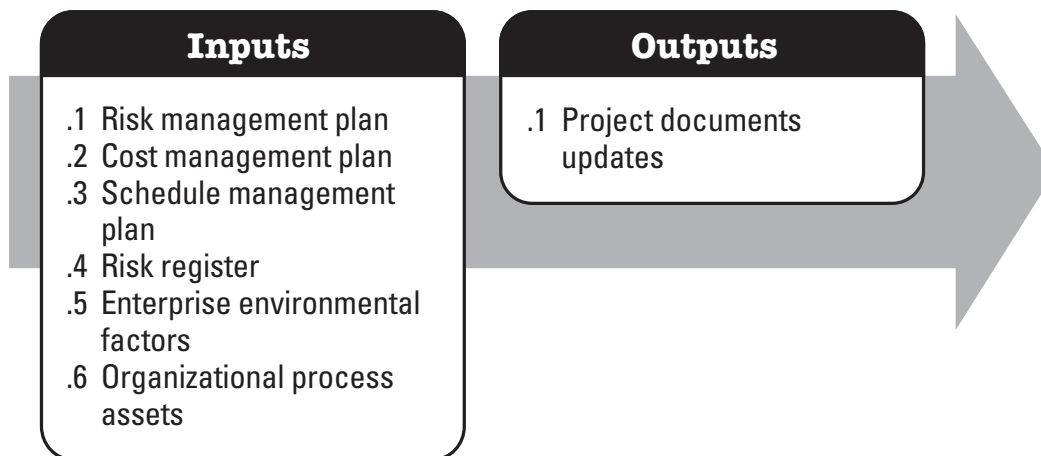

Figure A1-28. Perform Quantitative Risk Analysis: Inputs and Outputs

A1.5.22 Plan Risk Responses

Plan Risk Responses is the process of developing options and actions to enhance opportunities and to reduce threats to project objectives. The key benefit of this process is that it addresses the risks by their priority, inserting resources and activities into the budget, schedule and project management plan as needed. The inputs and outputs of this process are depicted in Figure A1-29.

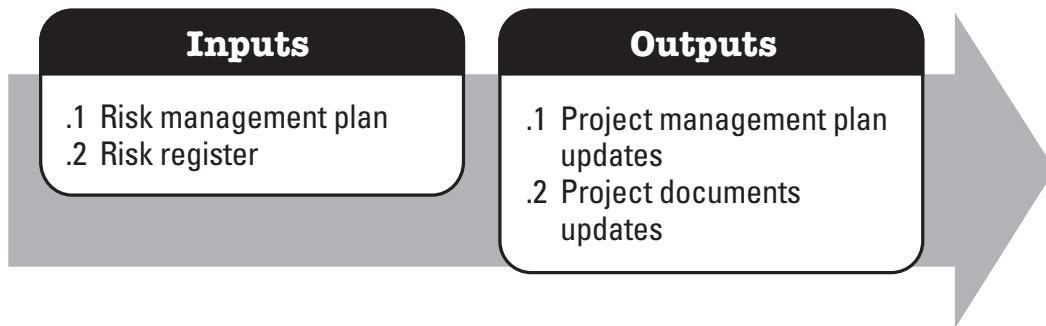

Figure A1-29. Plan Risk Responses: Inputs and Outputs

A1.5.23 Plan Procurement Management

Plan Procurement Management is the process of documenting project procurement decisions, specifying the approach, and identifying potential sellers. The key benefit of this process is that it determines whether to acquire outside support, and if so, what to acquire, how to acquire it, how much is needed, and when to acquire it. The inputs and outputs of this process are depicted in Figure A1-30.

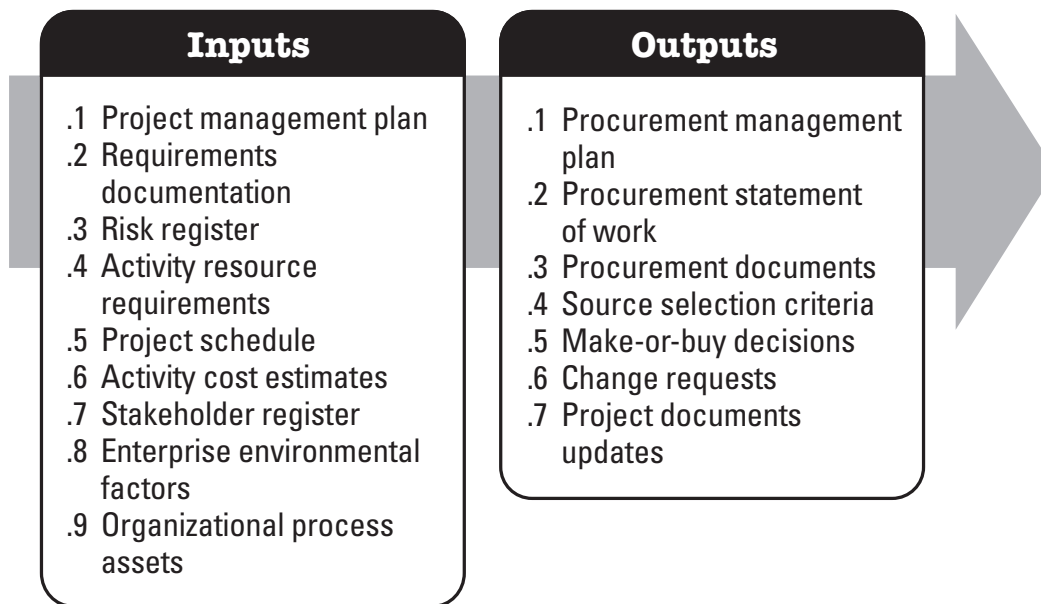

Figure A1-30. Plan Procurement Management: Inputs and Outputs

A1.5.24 Plan Stakeholder Management

Plan Stakeholder Management is the process of developing appropriate management strategies to effectively engage stakeholders throughout the project life cycle, based on the analysis of their needs, interests, and potential impact on project success. The key benefit of this process is that it provides a clear, actionable plan to interact with project stakeholders to support the project's interests. The inputs and outputs of this process are depicted in Figure A1-31.

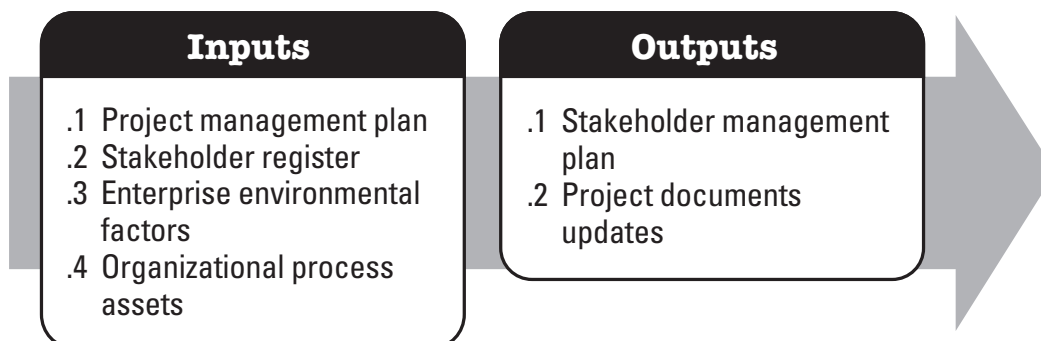

Figure A1-31. Plan Stakeholder Management: Inputs and Outputs

A1.6 Executing Process Group

The Executing Process Group consists of those processes performed to complete the work defined in the project management plan to satisfy the project specifications. This Process Group involves coordinating people and resources, managing stakeholder expectations, as well as integrating and performing the activities of the project in accordance with the project management plan (Figure A1-32).

During project execution, results may require planning updates and rebaselining. This can include changes to expected activity durations, changes in resource productivity and availability, and unanticipated risks. Such variances may affect the project management plan or project documents and may require detailed analysis and development of appropriate project management responses. The results of the analysis can trigger change requests that, if approved, may modify the project management plan or other project documents and possibly require establishing new baselines. A large portion of the project's budget will be expended in performing the Executing Process Group processes. The Executing Process Group (Figure A1-32) includes the project management processes identified in Figures A1-33 through A1-40 (see Sections A1.6.1 through A1.6.8).

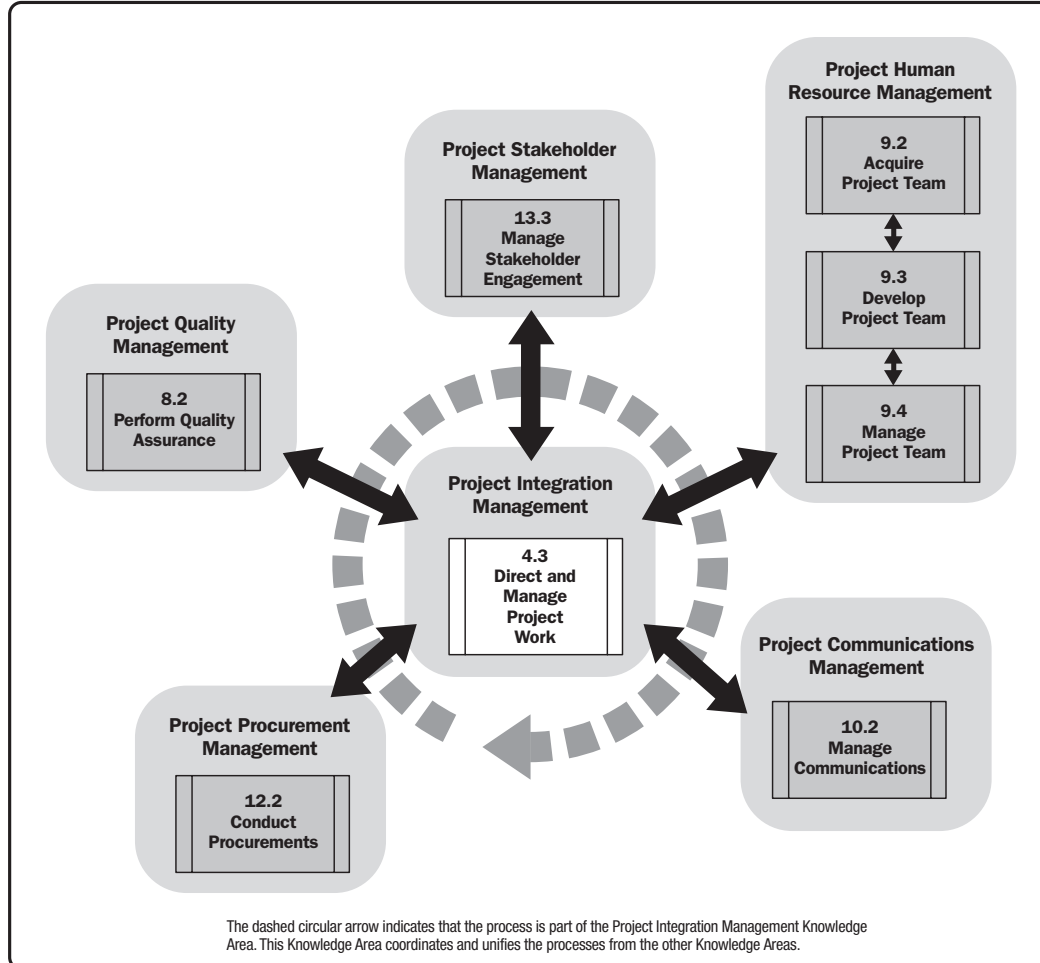

Figure A1-32. Executing Process Group

A1.6.1 Direct and Manage Project Work

Direct and Manage Project Work is the process of leading and performing the work defined in the project management plan and implementing approved changes to achieve the project's objectives. The key benefit of this process is that it provides overall management of the project work. The inputs and outputs of this process are depicted in Figure A1-33.

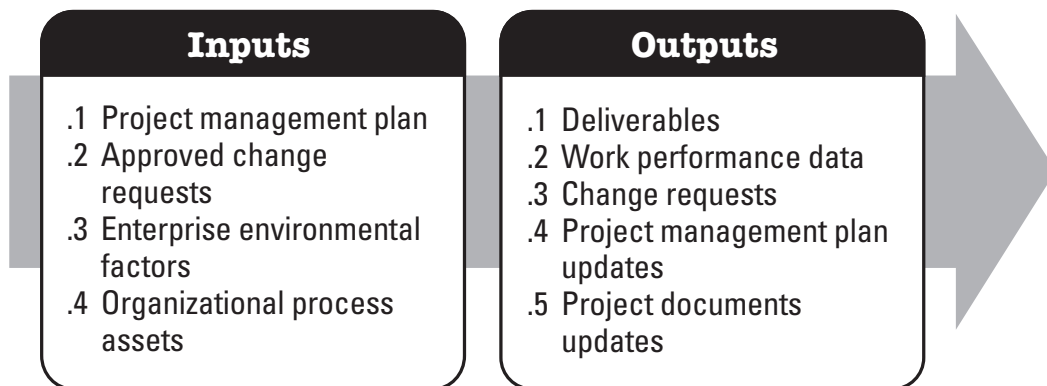

Figure A1-33. Direct and Manage Project Work: Inputs and Outputs

A1.6.2 Perform Quality Assurance

Perform Quality Assurance is the process of auditing the quality requirements and the results from quality control measurements to ensure that appropriate quality standards and operational definitions are used. The key benefit of this process is it facilitates the improvement of quality processes. The input and outputs of this process are depicted in Figure A1-34.

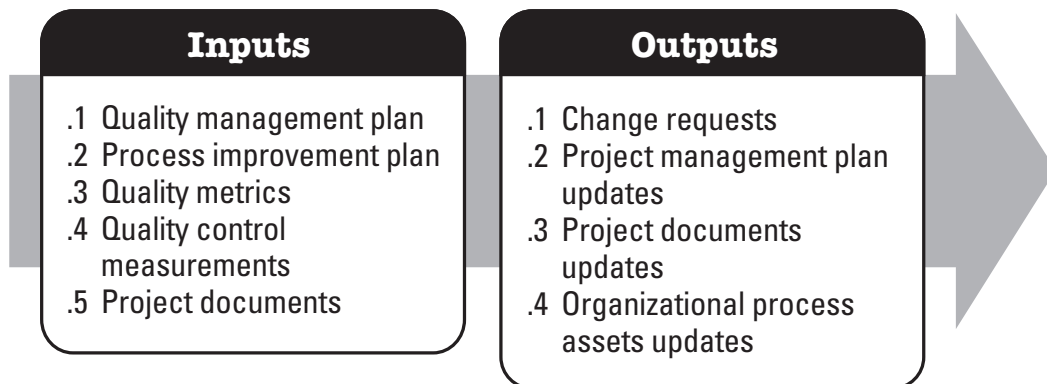

Figure A1-34. Perform Quality Assurance: Inputs and Outputs

A1.6.3 Acquire Project Team

Acquire Project Team is the process of confirming human resource availability and obtaining the team necessary to complete project activities. The key benefit of this process consists of outlining and guiding the team selection and responsibility assignment to obtain a successful team. The inputs and outputs of this process are depicted in Figure A1-35.

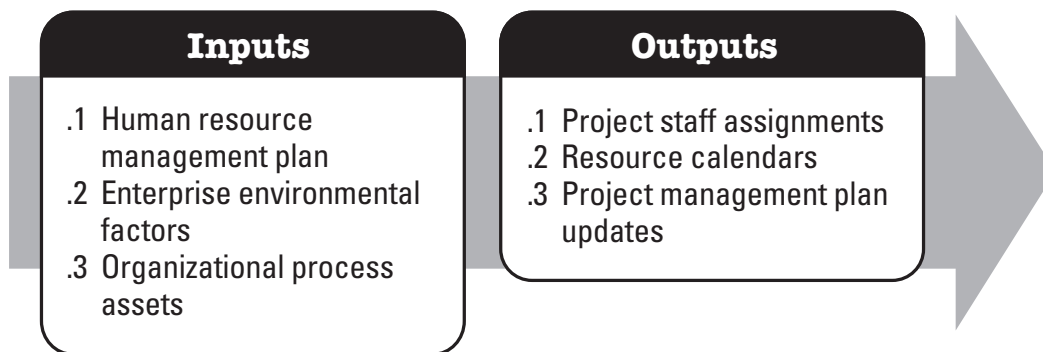

Figure A1-35. Acquire Project Team: Inputs and Outputs

A1.6.4 Develop Project Team

Develop Project Team is the process of improving competencies, team member interaction, and overall team environment to enhance project performance. The key benefit of this process is that it results in improved teamwork, enhanced people skills and competencies, motivated employees, reduced staff turnover rates, and improved overall project performance. The inputs and outputs of this process are depicted in Figure A1-36.

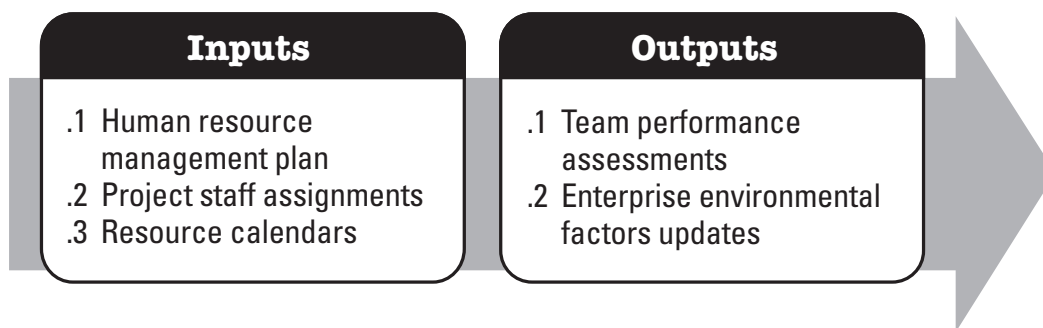

Figure A1-36. Develop Project Team: Inputs and Outputs

A1.6.5 Manage Project Team

Manage Project Team is the process of tracking team member performance, providing feedback, resolving issues, and managing team changes to optimize project performance. The key benefit of this process is that it influences team behavior, manages conflict, resolves issues, and appraises team member performance. The inputs and outputs of this process are depicted in Figure A1-37.

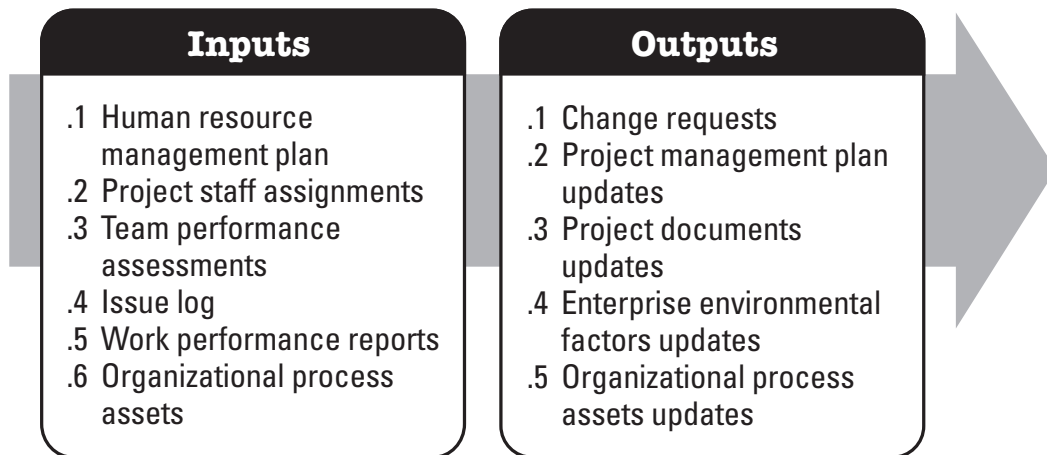

Figure A1-37. Manage Project Team: Inputs and Outputs

A1.6.6 Manage Communications

Manage Communications is the process of creating, collecting, distributing, storing, retrieving, and the ultimate disposition of project information in accordance with the communications management plan. The key benefit of this process is that it enables an efficient and effective communications flow between project stakeholders. The inputs and outputs of this process are depicted in Figure A1-38.

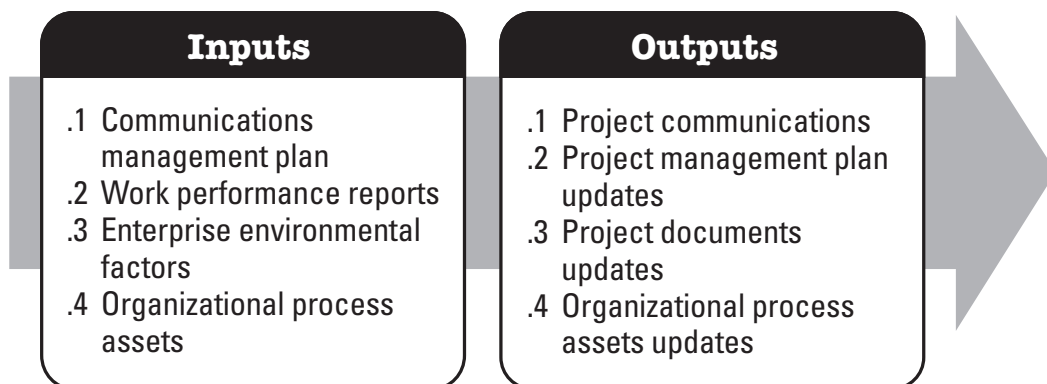

Figure A1-38. Manage Communications: Inputs and Outputs

A1.6.7 Conduct Procurements

Conduct Procurements is the process of obtaining seller responses, selecting a seller, and awarding a contract. The key benefit of this process is that it provides alignment of internal and external stakeholder expectations through established agreements. The inputs and outputs of this process are depicted in Figure A1-39.

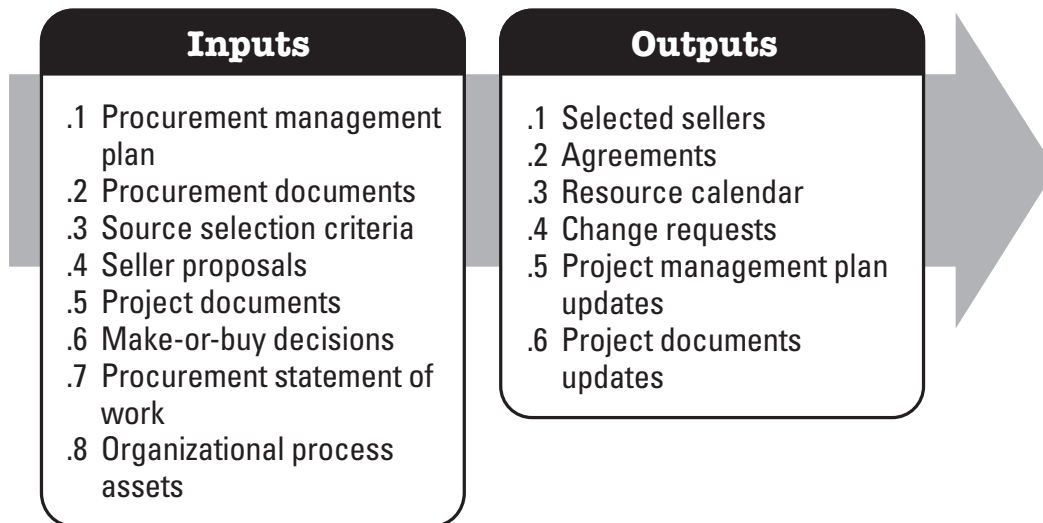

Figure A1-39. Conduct Procurements: Inputs and Outputs

A1.6.8 Manage Stakeholder Engagement

Manage Stakeholder Engagement is the process of communicating and working with stakeholders to meet their needs/expectations, address issues as they occur, and foster appropriate stakeholder engagement in project activities throughout the project life cycle. The key benefit of this process is that it allows the project manager to increase support and minimize resistance from stakeholders, significantly increasing the chances to achieve project success. The inputs and outputs of this process are depicted in Figure A1-40.

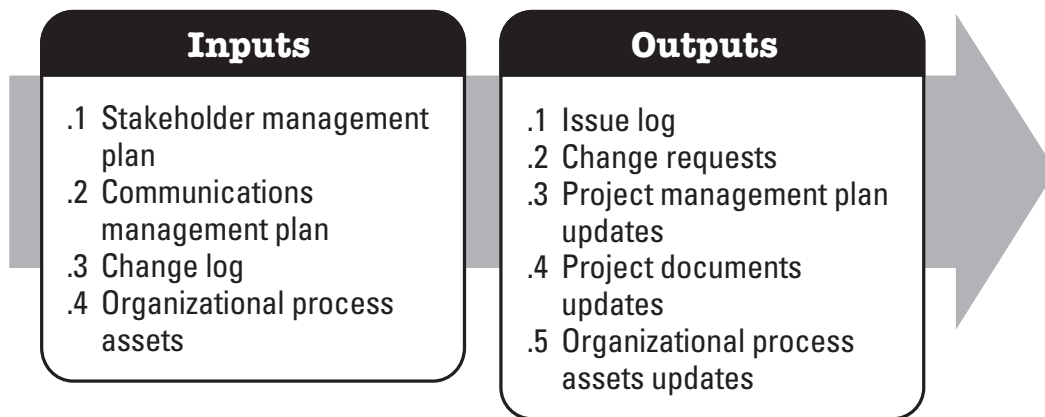

Figure A1-40. Manage Stakeholder Engagement: Inputs and Outputs

A1.7 Monitoring and Controlling Process Group

The Monitoring and Controlling Process Group consists of those processes required to track, review, and orchestrate the progress and performance of the project; identify any areas in which changes to the plan are required; and initiate the corresponding changes. The key benefit of this Process Group is that project performance is measured and analyzed at regular intervals, appropriate events or exception conditions to identify variances from the project management plan. The Monitoring and Controlling Process Group also involves:

- Controlling changes and recommending corrective or preventive action in anticipation of possible problems,
- Monitoring the ongoing project activities against the project management plan and the project performance measurement baseline, and
- Influencing the factors that could circumvent integrated change control or configuration management so only approved changes are implemented.

This continuous monitoring provides the project team insight into the health of the project and identifies any areas requiring additional attention. The Monitoring and Controlling Process Group not only monitors and controls the work being done within a Process Group, but also monitors and controls the entire project effort. In multiphase projects, the Monitoring and Controlling Process Group coordinates project phases in order to implement corrective or preventive actions to bring the project into compliance with the project management plan. This review can result in recommended and approved updates to the project management plan. For example, a missed activity finish date may require adjustments and trade-offs between budget and schedule objectives. In order to reduce control overheads, management by exception procedures and other techniques can be appropriately considered. The Monitoring and Controlling Process Group (Figure A1-41) includes the following project management processes (Sections A1.7.1 through A1.7.11):

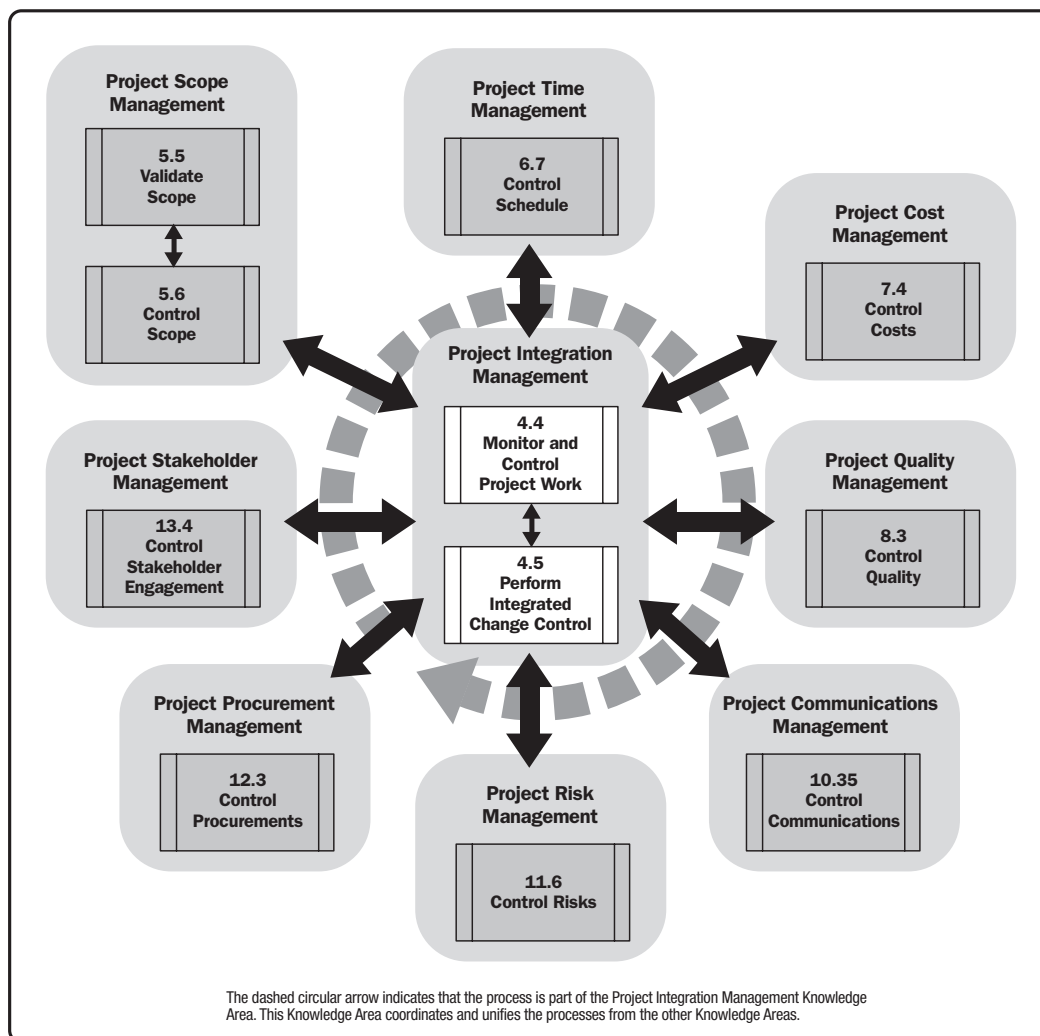

Figure A1-41. Monitoring and Controlling Process Group

A1.7.1 Monitor and Control Project Work

Monitor and Control Project Work is the process of tracking, reviewing, and reporting the progress to meet the performance objectives defined in the project management plan. The key benefit of this process is that it allows stakeholders to understand the current state of the project; the steps taken; and budget, schedule, and scope forecasts. The inputs and outputs for this process are depicted in Figure A1-42.

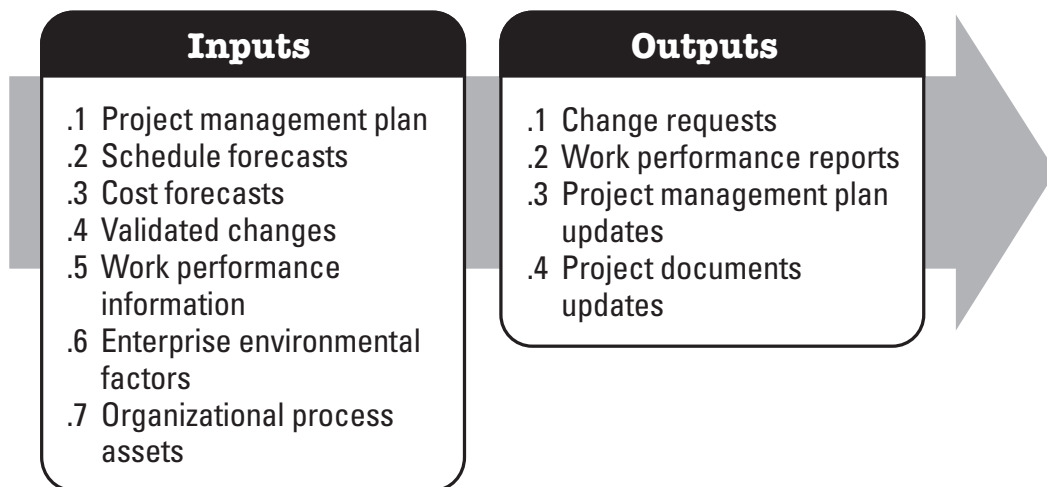

Figure A1-42. Monitor and Control Project Work: Inputs and Outputs

A1.7.2 Perform Integrated Change Control

Perform Integrated Change Control is the process of reviewing all change requests; approving changes and managing changes to deliverables, organizational process assets, project documents, and the project management plan; and communicating their disposition. It reviews all requests for changes or modifications to project documents, deliverables, baselines or the project management plan, and approves or rejects the changes. The key benefit of this process is that it allows for documented changes within the project to be considered in an integrated fashion while reducing project risk, which often arises from changes made without consideration to the overall project objectives or plans. The inputs and outputs of this process are depicted in Figure A1-43.

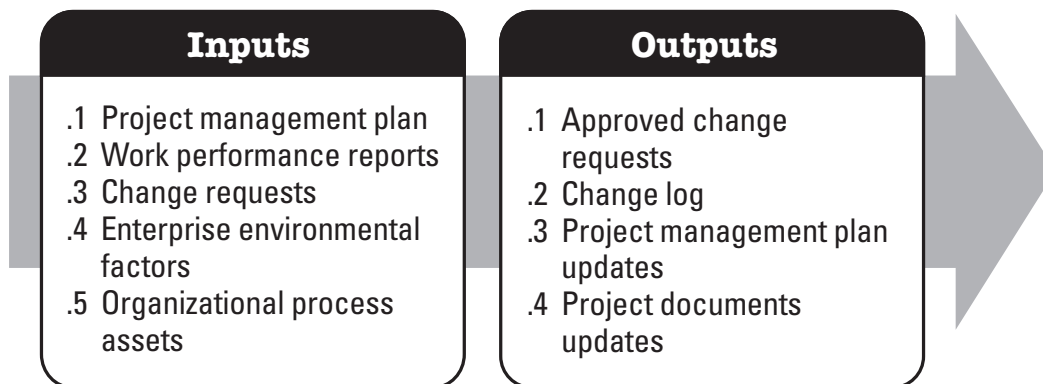

Figure A1-43. Perform Integrated Change Control: Inputs and Outputs

A1.7.3 Validate Scope

Validate Scope is the process of formalizing acceptance of the completed project deliverables. The key benefit of this process is that it brings objectivity to the acceptance process and increases the chance of final product, service, or result acceptance by validating each deliverable. The inputs and outputs of this process are depicted in Figure A1-44.

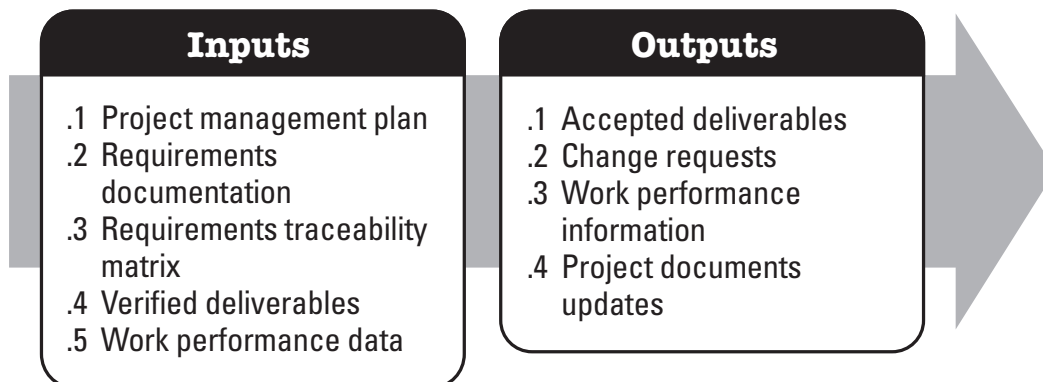

Figure A1-44. Validate Scope: Inputs and Outputs

A1.7.4 Control Scope

Control Scope is the process of monitoring the status of the project and product scope and managing changes to the scope baseline. The key benefit of this process is that it allows the scope baseline to be maintained throughout the project. The inputs and outputs of this process are depicted in Figure A1-45.

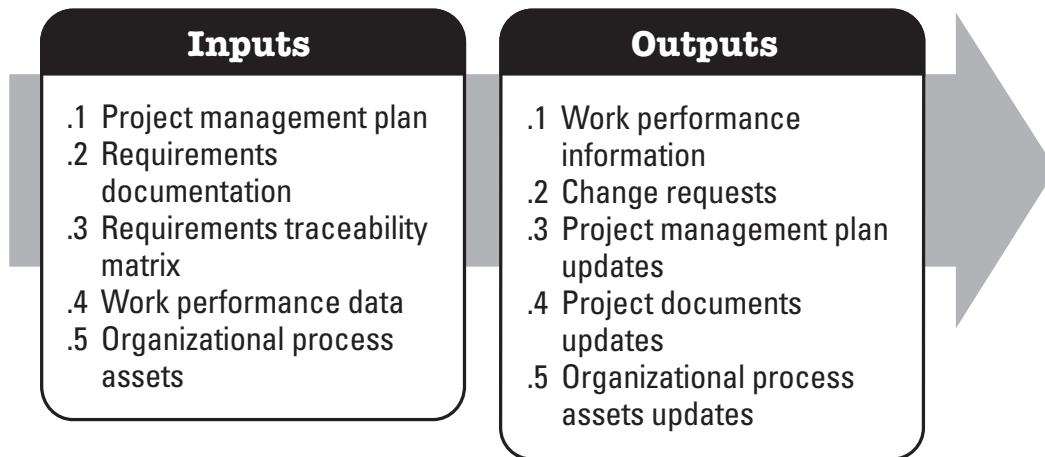

Figure A1-45. Control Scope: Inputs and Outputs

A1.7.5 Control Schedule

Control Schedule is the process of monitoring the status of project activities to update project progress and manage changes to the schedule baseline to achieve the plan. The key benefit of this process is that it provides the means to recognize deviation from the plan and take corrective and preventive actions and thus minimize risk. The inputs and outputs of this process are depicted in Figure A1-46.

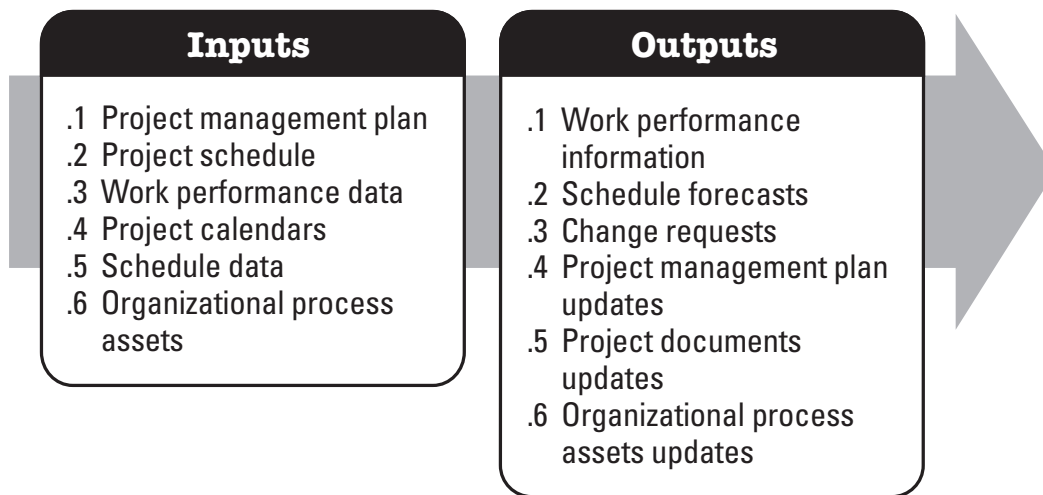

Figure A1-46. Control Schedule: Inputs and Outputs

A1.7.6 Control Costs

Control Costs is the process of monitoring the status of the project to update the project costs and managing changes to the cost baseline. The key benefit of this process is that it provides the means to recognize variance from the plan in order to take corrective action and minimize risk. The inputs and outputs of this process are depicted in Figure A1-47.

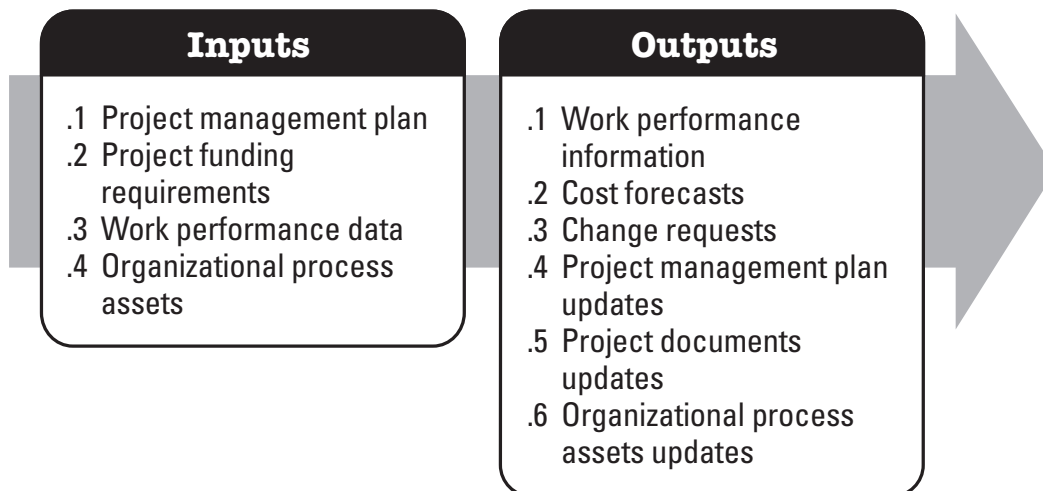

Figure A1-47. Control Costs: Inputs and Outputs

A1.7.7 Control Quality

Control Quality is the process of monitoring and recording results of executing the quality activities to assess performance and recommend necessary changes. The key benefits of this process include: (1) identifying the causes of poor process or product quality and recommending and/or taking action to eliminate them; and (2) validating that project deliverables and work meet the requirements specified by key stakeholders necessary for final acceptance. The inputs and outputs of this process are depicted in Figure A1-48.

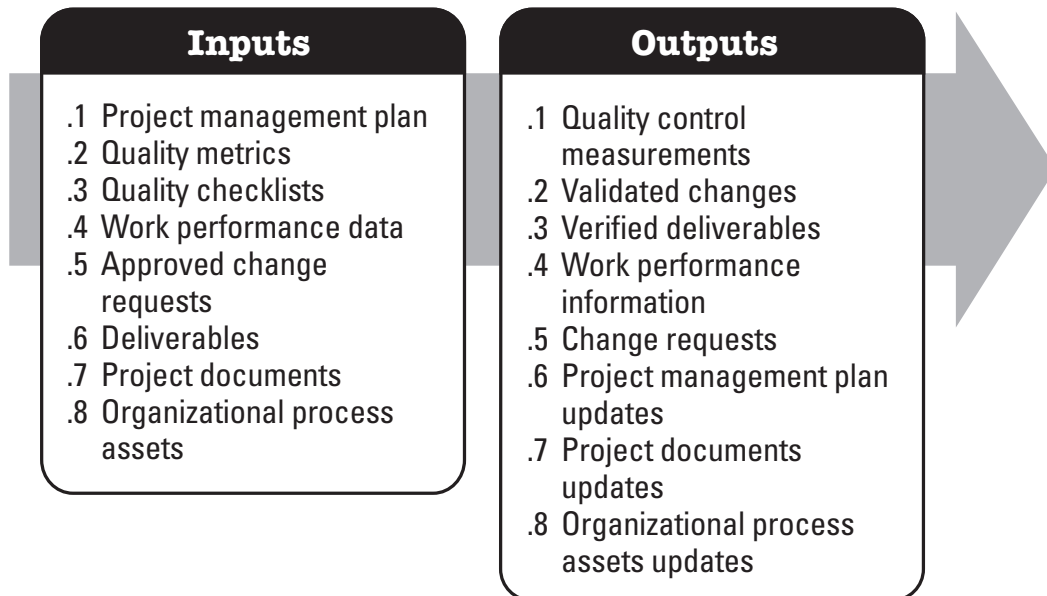

Figure A1-48. Control Quality: Inputs and Outputs

A1.7.8 Control Communications

Control Communications is the process of monitoring and controlling communications throughout the entire project life cycle to ensure the information needs of the project stakeholders are met. The key benefit of this process is that it ensures an optimal information flow among all communication participants at any moment in time. The inputs and outputs of this process are depicted in Figure A1-49.

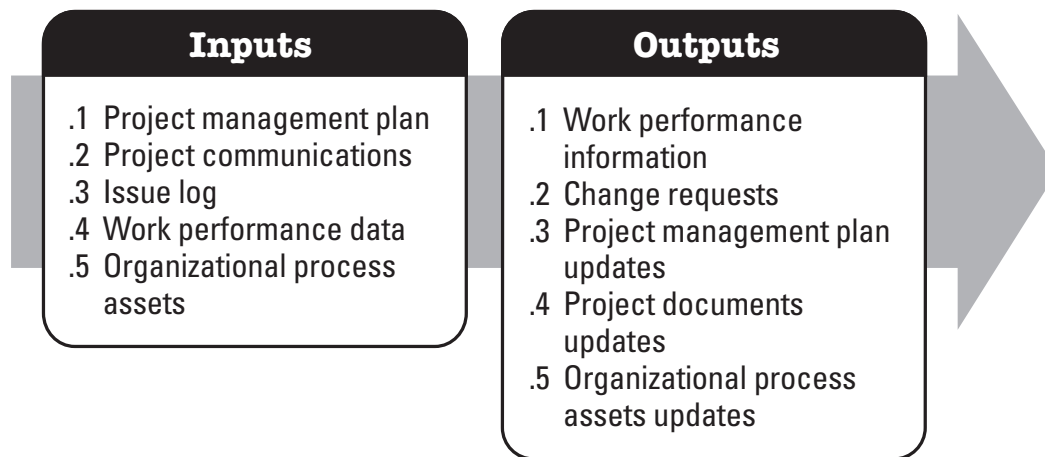

Figure A1-49. Control Communications: Inputs and Outputs

A1.7.9 Control Risks

Control Risks is the process of implementing risk response plans, tracking identified risks, monitoring residual risks, identifying new risks, and evaluating risk process effectiveness throughout the project. The key benefit of this process is that it improves efficiency of the risk approach throughout the project life cycle to continuously optimize risk responses. The inputs and outputs of this process are depicted in Figure A1-50.

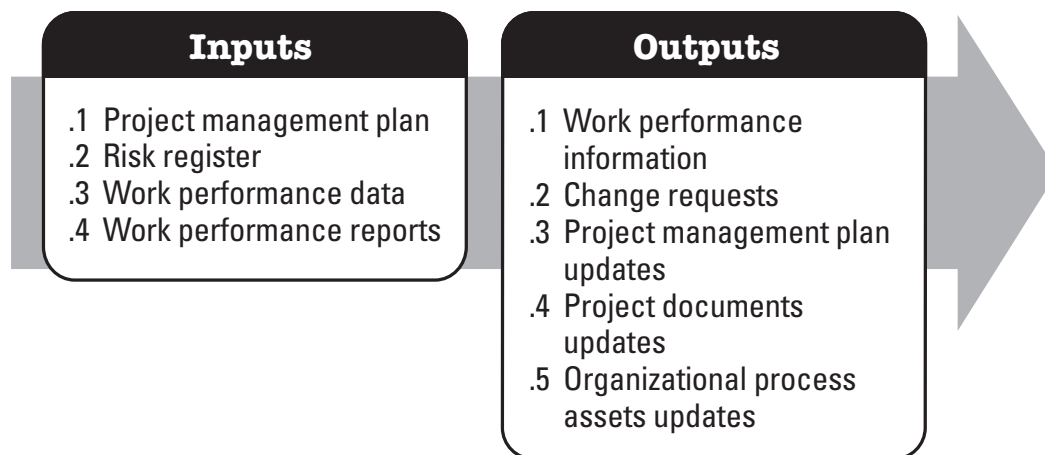

Figure A1-50. Control Risks: Inputs and Outputs

A1.7.10 Control Procurements

Control Procurements is the process of managing procurement relationships, monitoring contract performance, and making changes and corrections to contracts as appropriate. The key benefit of this process is that it ensures that both the seller's and buyer's performance meets procurement requirements according to the terms of the legal agreement. The inputs and outputs of this process are depicted in Figure A1-51.

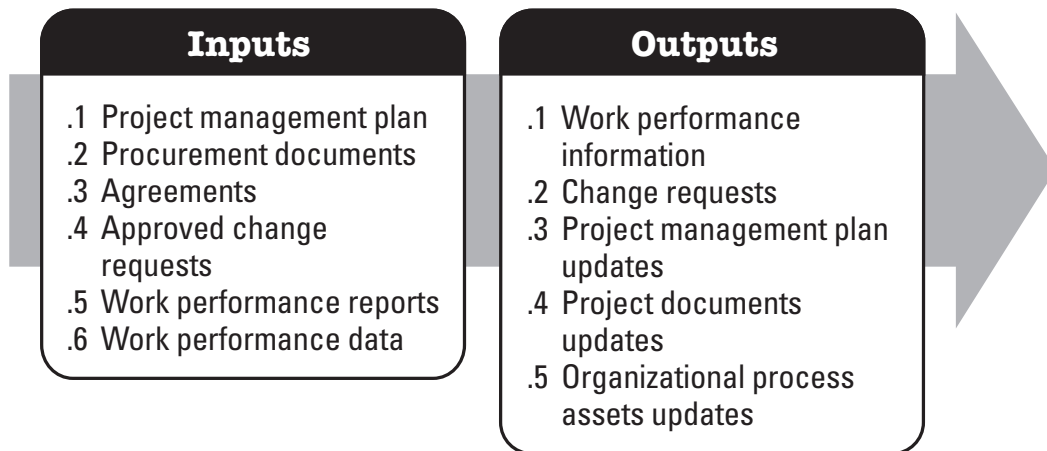

Figure A1-51. Control Procurements: Inputs and Outputs

A1.7.11 Control Stakeholder Engagement

Control Stakeholder Engagement is the process of monitoring overall project stakeholder relationships and adjusting strategies and plans for engaging stakeholders. The key benefit of this process is that it will maintain or increase the efficiency and effectiveness of stakeholder engagement activities as the project evolves and its environment changes. The inputs and outputs of this process are depicted in Figure A1-52.

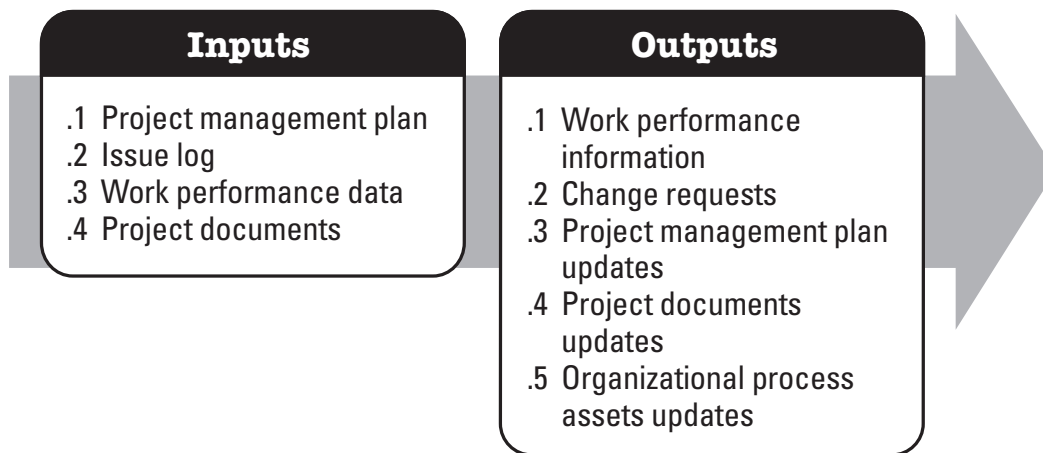

Figure A1-52. Control Stakeholder Engagement: Inputs and Outputs

A1.8 Closing Process Group

The Closing Process Group consists of those processes performed to conclude all activities across all Project Management Process Groups to formally complete the project, phase, or contractual obligations. This Process Group, when completed, verifies that the defined processes are completed within all the Process Groups to close the project or a project phase, as appropriate, and formally establishes that the project or project phase is complete.

This Process Group also formally establishes the premature closure of the project. Prematurely closed projects may include, for example: aborted projects, cancelled projects, and projects in a critical situation. In specific cases, when some contracts cannot be formally closed (e.g. claims, ending clauses etc.) or some activities are to be transferred to other organizational units, specific hand-over procedures may be arranged and finalized.

At project or phase closure, the following may occur:

- Obtain acceptance by the customer or sponsor to formally close the project or phase,
- Conduct post-project or phase-end review,
- Record impacts of tailoring to any process,
- Document lessons learned,

- Apply appropriate updates to organizational process assets,
- Archive all relevant project documents in the project management information system (PMIS) to be used as historical data,
- Close out all procurements activities ensuring termination of all relevant agreements, and
- Perform team members' assessment and release project resources.

The Closing Process Group (Figure A1-53) includes the following project management processes (See Sections A1.8.1 and A1.8.2):

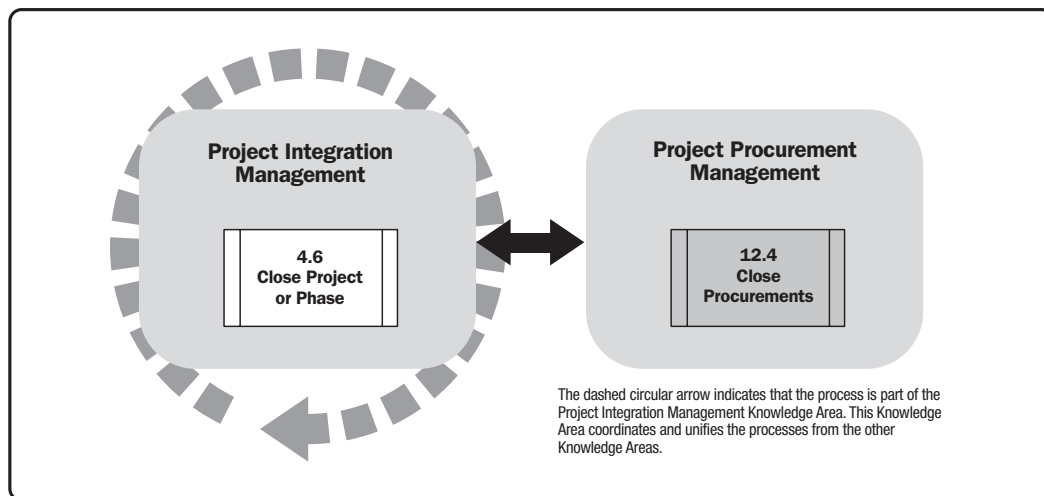

Figure A1-53. Closing Process Group

A1.8.1 Close Project or Phase

Close Project or Phase is the process of finalizing all activities across all of the Project Management Process Groups to formally complete the project or phase. The key benefit of this process is that it provides lessons learned, the formal ending of project work, and the release of organization resources to pursue new endeavors. The inputs and outputs of this process are depicted in Figure A1-54.

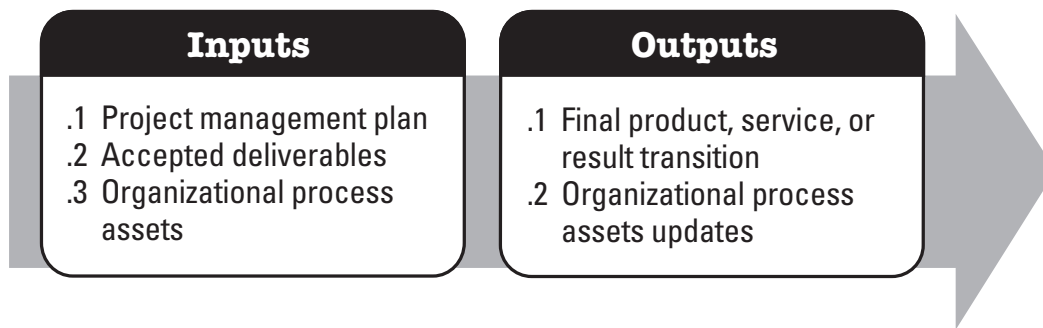

Figure A1-54. Close Project or Phase: Inputs and Outputs

A1.8.2 Close Procurements

Close Procurements is the process of completing each procurement. The key benefit of this process is that it documents agreements and related documentation for future reference. The inputs and outputs of this process are depicted in Figure A1-55.

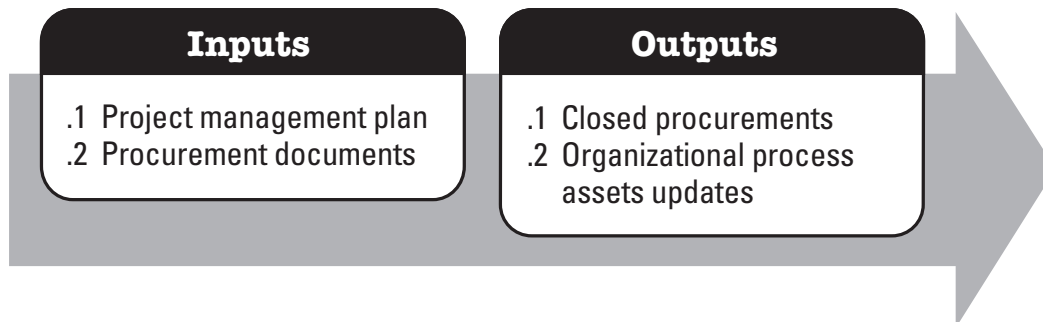

Figure A1-55. Close Procurements: Inputs and Outputs

APPENDIX X1

FIFTH EDITION CHANGES

The purpose of this appendix is to give a detailed explanation of the changes made to *A Guide to the Project Management Body of Knowledge (PMBOK® Guide)*—Fourth Edition to create the *PMBOK® Guide*—Fifth Edition.

X1.1 Scope of Update

The approved scope for the *PMBOK® Guide* – Fifth Edition explicitly states:

- Comments and feedback, both deferred during the development of the *PMBOK® Guide* – Fourth Edition and received by PMI since its development, will be reviewed and determined whether material will be included or excluded in the new edition.
- Review all text and graphics in the document to make sure the information is accurate, clear, complete and relevant, revising as necessary.
- Review, interpret, and ensure appropriate alignment with ISO 21500 [12] in the development of the standard.
- Ensure harmonization with any other relevant PMI standards.
- Consider project management role delineation study results, as appropriate.
- Reposition Section 3 (The Standard for Project Management) as a stand-alone, ANSI-approved standard included within the Fifth Edition as an Appendix or attachment.
- Standard is written for project management practitioners and other stakeholders of the project management profession.
- Standard describes the principles and processes that shape the practices that are unique to projects.
- Standard ensures that any terminology contained within the *PMI Lexicon* is represented consistently and identically in the standard.

With that directive in mind, the update team adopted an approach aimed at achieving a greater degree of consistency and clarity by refining the processes, standardizing inputs and outputs where possible, and implementing a global approach for documenting the inputs and outputs.

Along with a focus on consistency and clarity, the update team worked to complete the requirements for factoring feedback received for the *PMBOK® Guide – Fourth Edition*, and ensure alignment and harmonization with relevant PMI standards, ISO 21500, *PMI Lexicon of Project Management Terms*, and the PMI role delineation study for project managers.

X1.2 Rules for Handling Inputs, Tools and Techniques, and Outputs (ITTOs)

Business rules were established to further aid consistency in handling the order and detail of information within the ITTOs for each project management process. These rules are:

- *ITTO Fundamental Rules:*
 - Inputs are any documents that are *key* to the process.
 - Process outputs should map as an input to another project management process unless the output is a terminal output or embedded within another input such as process documents.
 - Process inputs should map as an output from another project management process unless the input comes from outside the project.
- *Project Documents Rules:*
 - On the ITTO input list, if the input is a major project document, it needs to be specifically listed out.
 - On the ITTO output list, specific project documents are put on the list the first time they are created as an output. Subsequently, these are listed as “project document updates” on the ITTO output list, and described in the section narrative.
- *Project Management Plan Rules:*
 - On the ITTO input list, if the subsidiary plans and baselines from the project management plan serve as major process inputs, then these need to be specifically listed out.
 - On the ITTO output list, subsidiary plans and baselines for the project management plan are grouped as a single output as “project management plan updates” and described in the section narrative.
 - On the ITTO input list, for those planning processes that create a subsidiary plan, the project management plan is listed as the key input.
 - For control processes, the key input is “project management plan,” rather than specific subsidiary plans. And the output is “project management plan updates” rather than an update to a specific subsidiary plan.

- *EEF/OPA Referencing Rule for Process Inputs:*
 - When referencing EEFs or OPAs, include the phrase “Described in Section” and state 2.1.4 for OPAs or 2.1.5 for EEFs.
- *Other Consistency Rules:*
 - Rename “project document update” and “organizational process asset updates” to “project documents updates” and “organizational process assets updates.”
 - For consistency across the *PMBOK® Guide*, document titles are not to be capitalized in the text.
- *Sequencing Rules:*
 - For inputs and outputs: plans, subsidiary plans, and baselines are listed first.
 - Project management plan first, then subsidiary plans, then baselines.
 - When plans are a major output, they are always listed first.
 - For inputs work performance data/information/reports, these are listed immediately before the enterprise environmental factors.
 - Enterprise environmental factors and organizational process assets are listed last in that order.
 - Tools and techniques have meetings listed last.
 - When updates are an output they are listed in the following sequence:
 - Project management plan/subsidiary plan updates,
 - Project documents updates,
 - Enterprise environmental factors updates, and
 - Organizational process assets updates.

X1.3 Established Rules for Ensuring Harmonization Between Glossary Terms and the PMI Lexicon of Project Management Terms

To ensure that terms used in the *PMBOK® Guide* align with the *PMI Lexicon of Project Management Terms* and harmonize with other PMI standards, business rules were established and adhered to in the Fifth Edition update.

- For terms found in both the *PMBOK® Guide* and the *PMI Lexicon*, the definition from the *PMI Lexicon* takes precedence.
- Where terms used in the *PMBOK® Guide* are not found in the *PMI Lexicon* but are found in other relevant PMI standards (e.g., *The Standard for Program Management*, *Organizational Project Management Maturity Model (OPM3®)*, *The Standard for Portfolio Management*, *Practice Standard for Earned Value Management*, *Practice Standard for Scheduling*, etc.), the definition of the terms shall be the same. If the definitions do not align with the respective standards, the term is elevated to the PMI Lexicon team for assistance in creating an acceptable common definition.

X1.4 Project Management Plan and Its Subsidiary Plans

To improve consistency and aid clarity around the various subsidiary plans that make up the overall project management plan, the team added four planning processes: Plan Scope Management, Plan Schedule Management, Plan Cost Management, and Plan Stakeholder Management. These changes bring back the scope planning process from the Third Edition and add three new planning processes. The additions provide clearer guidance for the concept that each major Knowledge Area has a need for the project team to actively think through and plan how aspects from the related processes are planned and managed. It also reinforces the concept that each of the subsidiary plans are integrated through the overall project management plan, which becomes the major planning document for guiding further project planning and execution.

This change also ensures harmonization with other PMI standards. For example, a detailed planning process for Plan Schedule Management reinforces the need for detailed planning to address project scheduling issues such as selecting the scheduling method and tool during early planning stages as part of the overall Project Time Management processes. This concept of detailed planning for project scheduling related decisions aligns with the *Practice Standard for Scheduling* and ensures harmonization across PMI standards.

X1.5 Consistency in Handling Project Management Work Execution Data and Information Flow

To improve consistency and add clarity regarding project data and information flows during project work execution, the team redefined work performance data, work performance information, and work performance reports to align with the DIKW (Data, Information, Knowledge, Wisdom) model used in the field of Knowledge Management.

- **Work Performance Data.** The raw observations and measurements identified during activities performed to carry out the project work. Examples include reported percent of work physically completed, quality technical performance measures, start and finish dates of schedule activities, number of change requests, number of defects, actual costs, actual durations, etc.
- **Work Performance Information.** The performance data collected from various controlling processes, analyzed in context and integrated based on relationships across areas. Examples of performance information are status of deliverables, implementation status for change requests, forecasted estimates to complete.
- **Work Performance Reports.** The physical or electronic representation of work performance information compiled in project documents, intended to generate decisions, raise issues, actions, or awareness. Examples include status reports, memos, justifications, information notes, electronic dashboards, recommendations, and updates.

The redefined data model was then applied consistently to the inputs and outputs for the various controlling and executing processes as illustrated in Figure X1-1.

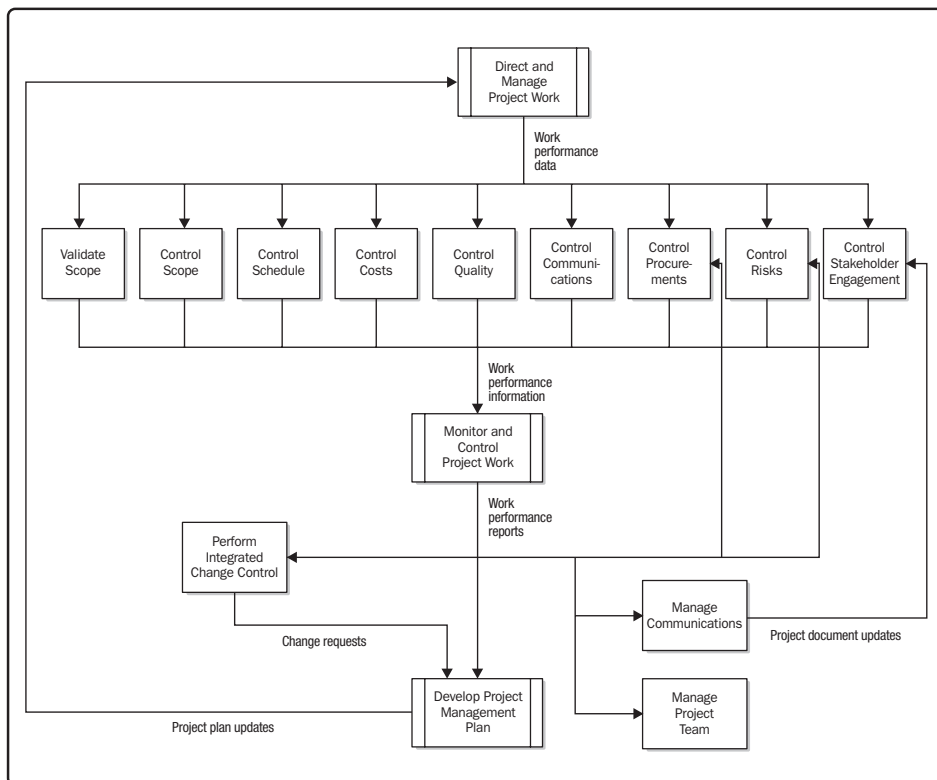

Figure X1-1. Refined Data Model

X1.6 Section 1—Introduction

Sections 1.2, 1.4, and 1.6 were realigned and harmonized with first sections in *The Standard for Program Management – Third Edition* and *The Standard for Portfolio Management – Third Edition*. This ensures the information regarding the relationship between projects, programs, and portfolios is treated consistently across all three standards. Additional text was added to Section 1.4.4 to expand the discussion on project management offices. Section 1.5 on Project Management and Operations Management was expanded to more broadly address the relationship among project management, operations management, and organizational strategy. A new section was added to address the importance of interpersonal skills of a project manager and refers the reader to Appendix X3 of the *PMBOK® Guide* for further discussion on the importance of interpersonal skills in managing projects. Section 1.8 on Enterprise Environmental Factors was moved to Section 2.

X1.7 Section 2—Project Life Cycle and Organization

The content of Section 2 was reorganized to improve content flow and understanding. The section on organizational influence on project management was moved to the beginning of the section and expanded to provide broader coverage of how organizational factors can influence the conduct of project teams. The discussion of enterprise environmental factors was moved into this section from Section 1. The section on stakeholders was expanded to better address project stakeholders and their impact on project governance. A new section was added to address the characteristics and structure of the project team. The section on project life cycle was moved to the end of the section and expanded to further explain life cycles and phases.

X1.8 Section 3 Project Management Processes for a Project

Section 3 of the *PMBOK® Guide – Fourth Edition* was moved into a new Annex in the *PMBOK® Guide – Fifth Edition* (Annex A1 – The Standard for Project Management of a Project). The introduction to this section was cleaned up and expanded to enable this annex to serve as a stand-alone document. This positions the Standard for Project Management away from the main body of the *PMBOK® Guide* material allowing the evolution of the Body of Knowledge material to be separate from the actual Standard for Project Management.

X1.9 New Section 3 for *PMBOK® Guide* – Fifth Edition

A replacement Section 3 was developed for the *PMBOK® Guide* – Fifth edition. This new section bridges the content between Sections 1 and 2 and the Knowledge Area sections. The new section introduces the project management processes and Process Groups as in the previous editions of the *PMBOK® Guide*. However, it does not list each of the processes associated with each of the Project Management Process Groups.

X1.10 Split Section 10 on Project Communications Management into Two Separate Sections

Deferred and post-publication comments on the Project Communications Knowledge Area of the *PMBOK® Guide* – Fourth Edition uncovered a need to modify this Knowledge Area as well as the processes within the Knowledge Area. In general, the comments fell into three groups:

- Eliminate confusion created between the processes of Distribute Information and Report Performance and their overlap with processes for Control Scope, Control Schedule, and Control Cost.
- Tighten the focus of Project Communications Management to planning for the communications needs of the project, collecting, storing, and disseminating project information, and monitoring overall project communications to ensure its efficiency.
- Break out and expand on stakeholder management concepts to reflect not solely upon (a) analyzing stakeholder expectations and its impact on the project, and (b) developing appropriate management strategies for effectively engaging stakeholders in project decisions and execution, but also upon continuous dialogue with stakeholders to meet their needs and expectations, address issues as they occur, and foster appropriate stakeholder engagement in project decisions and activities.

Planning for and managing the communication needs of the project as well as the stakeholders' needs are two distinct keys to project success. The concept being reinforced is that both are discrete Knowledge Areas in which stakeholder management is not simply better management of communications nor which improved communications is simply better stakeholder management. This concept drives the need to treat these two critical keys for project success as distinct areas.

Revamping this Knowledge Area by separating Project Stakeholders Management from Project Communications Management provides the following benefits:

- Focuses on not only managing the expectations of the various stakeholder groups but actively working to ensure an appropriate level of engagement of project stakeholders in the decision making and activities of the project.
- Aligns with the growing body of research showing stakeholder engagement as one of the keys to overall project success.
- Improves the alignment between the *PMBOK® Guide* and *The Standard for Program Management*.
- Aligns better with the focus on stakeholder management being put forward with the new ISO 21500 standard.
- Allows better emphasis on Project Communications Management by focusing on the main purpose of communication activities to collect, store, organize, and distribute project information.
- Enables the realignment of project communications processes, thus addressing the confusion and overlap surrounding project performance analysis and reporting.

Section 10 was separated into two distinct Knowledge Areas: Project Communications Management and Project Stakeholder Management. This change takes the communication processes currently contained in Section 10 and refocuses them to project communications planning, executing, and controlling. The two current stakeholder aligned processes within Section 10 (Identify Stakeholders and Manage Stakeholder Expectations) were moved into a new section addressing stakeholder management. Stakeholder-related text from Section 2.3 was also moved into this new section. The project management processes related to managing project stakeholders were expanded to include:

- Identify Stakeholders,
- Develop Stakeholder Management Plan,
- Manage Stakeholder Engagement, and
- Control Stakeholder Engagement.

X1.11 Process Changes

As part of the process, changes several process names were changed to improve consistency across the processes and to improve clarity. All processes that create a subsidiary plan were named using the form of Plan {XXX} Management. The Monitor and Controlling processes were named using the form Control {XXX}, since the act of controlling a process includes monitoring the process. These changes improved the consistency of how processes are named across all processes. In addition to process name changes, several other processes were added or modified as described elsewhere in this appendix. The list below summarizes the process changes.

- 4.3 Direct and Manage Project Execution—changed to Direct and Manage Project Work
- 5.1 Plan Scope Management—added
- 5.5 Verify Scope—changed to Validate Scope
- 6.1 Plan Schedule Management—added
- 7.1 Plan Cost Management—added
- 8.1 Plan Quality—changed to Plan Quality Management
- 8.3 Perform Quality Control—changed to Control Quality
- 9.1 Develop Human Resource Plan—changed to Plan Human Resource Management
- 10.2 Plan Communications—changed to Section 10.1 Plan Communications Management
- 10.3 Distribute Information—changed to Section 10.2 Manage Communications
- 10.5 Report Performance—changed to Section 10.3 Control Communications
- 11.6 Monitor and Control Risks—changed to Control Risks
- 12.1 Plan Procurements—changed to Plan Procurement Management
- 12.3 Administer Procurements—changed to Control Procurements
- 10.1 Identify Stakeholders—moved to Section 13.1 Identify Stakeholders
- 13.2 Plan Stakeholder Management—added
- 10.4 Manage Stakeholder Expectations—changed to Section 13.3 Manage Stakeholders Engagement
- 13.4 Control Stakeholders Engagement—added

X1.12 Section 4—Project Integration Management Changes

Process definitions were revised for Develop Project Charter, Develop Project Management Plan, Direct and Manage Project Work, Monitor and Control Project Work, and Perform Integrated Change Control to better align with the *PMI Lexicon* and improve clarity of the definitions. The Direct and Manage Project Execution was renamed to Direct and Manage Project Work to better align with its definition and reinforce that this process applies beyond the Executing processes. Other changes consist primarily of expanded explanations, refinements to tools and techniques for several processes, and refinements to the inputs and outputs for several processes to better tie the integration processes to other project management processes. A table was added to the discussion of the output for of the Develop Project Management Plan process to bring clarity to the differentiation between project documents and Inputs and outputs were adjusted for several processes to reflect the new model of project data and information flow during the execution of project work.

The following table summarizes the Section 4 processes:

Table X1-1. Section 4 Changes

Fourth Edition Sections	Fifth Edition Sections
4.1 Develop Project Charter	4.1 Develop Project Charter
4.2 Develop Project Management Plan	4.2 Develop Project Management Plan
4.3 Direct and Manage Project Execution	4.3 Direct and Manage Project Work
4.4 Monitor and Control Project Work	4.4 Monitor and Control Project Work
4.5 Perform Integrated Change Control	4.5 Perform Integrated Change Control
4.6 Close Project or Phase	4.6 Close Project or Phase

X1.13 Section 5—Project Scope Management Changes

In Section 5.1, the concept of a Develop Scope Management Plan process was brought back as a way to ensure consistency across all project planning processes and to reinforce that subsidiary plans are developed to plan the details for each major Knowledge Area. To support consistency in naming, the processes that create the subsidiary plans, the Develop Scope Management Plan was named Plan Scope Management. The discussion within the Collect Requirements process was expanded to make clear this process focuses on collecting all requirements necessary for project success. These requirements include the requirements for the product, service, or result to be delivered by the project, any quality requirements the project must meet, and any other project management related requirements deemed critical for project success. The Verify Scope process was renamed to Validate Scope and the text was reworked to add emphasis that this process is not solely about accepting deliverables but validating that the deliverables will deliver value to the business and confirms that the deliverables, as provided, will fulfill the project objectives, as well as their intended use to the project stakeholders. Inputs and outputs were adjusted for several processes to reflect the new model of project data and information flow during the execution of project work.

The following table summarizes the Section 5 processes:

Table X1-2. Section 5 Changes

Fourth Edition Sections	Fifth Edition Sections
	5.1 Plan Scope Management
5.1 Collect Requirements	5.2 Collect Requirements
5.2 Define Scope	5.3 Define Scope
5.3 Create WBS	5.4 Create WBS
5.4 Verify Scope	5.5 Validate Scope
5.5 Control Scope	5.6 Control Scope

X1.14 Section 6—Project Time Management Changes

Section 6 reflects changes within the industry and detailed in the *Practice Standard for Scheduling – Second Edition*.

As part of reinforcing the concept of detailed subsidiary plans being created for each major Knowledge Area and then aggregated into the overall project management plan, a new process was added for Plan Schedule Management. This process adds focus on the preliminary decisions around developing and maintaining the project's schedule model. Process definitions were revised for Define Activities, Estimate Activity Resources, Estimate Activity Durations, and Control Schedule to improve clarity of the definitions. Several processes were modified with new inputs and/or updated outputs. Agile concepts were incorporated into the Develop Schedule process. Figures and associated text were updated to clarify scheduling concepts addressed in the section. Added emphasis was placed on resource optimization techniques used in project scheduling. Some inputs and outputs were renamed for several processes to support consistency between the various project management processes. Inputs and outputs were adjusted for several processes to reflect the new model of project data and information flow during the execution of project work.

The following table summarizes the Section 6 processes:

Table X1-3. Section 6 Changes

Fourth Edition Sections	Fifth Edition Sections
	6.1 Plan Schedule Management
6.1 Define Activities	6.2 Define Activities
6.2 Sequence Activities	6.3 Sequence Activities
6.3 Estimate Activity Resources	6.4 Estimate Activity Resources
6.4 Estimate Activity Durations	6.5 Estimate Activity Durations
6.5 Develop Schedule	6.6 Develop Schedule
6.6 Control Schedule	6.7 Control Schedule

X1.15 Section 7—Project Cost Management Changes

Section 7 reflects changes coming from within the industry and detailed in the *Practice Standard for Estimating* and the *Practice Standard for Earned Value Management – Second Edition*.

As part of reinforcing the concept of detailed subsidiary plans being created for each major Knowledge Area and then aggregated into the overall project management plan, a new process was added for Plan Cost Management. This process adds focus on the preliminary decisions around developing and maintaining the project's cost estimates and budget. Added emphasis was placed on reserve analysis including contingency and management reserves with a new figure, Figure 7-8, added to illustrate the various components making up the project budget. A new table, Table 7-1 on earned value calculations summary, was added to collect in one place all of the formulas used for earned value analysis. Figures for earned value and project funding requirements were updated to reflect the added emphasis on management reserves. Some inputs and outputs were renamed for several processes to support consistency between the various project management processes. Inputs and outputs were adjusted for several processes to reflect the new model of project data and information flow during the execution of project work.

The following table summarizes the Section 7 processes:

Table X1-4. Section 7 Changes

Fourth Edition Sections	Fifth Edition Sections
	7.1 Plan Cost Management
7.1 Estimate Costs	7.2 Estimate Costs
7.2 Determine Budget	7.3 Determine Budget
7.3 Control Cost	7.4 Control Costs

X1.16 Section 8—Project Quality Management Changes

No new processes were added in the project management processes contained within this section. The Quality Planning process was renamed Plan Quality Management to support consistency in naming the processes that create the subsidiary plans. The definition for Plan Quality Management was updated to better align with the added focus on quality requirements for the project. The Perform Quality Control process was renamed Control Quality to support consistency in naming the various controlling processes. Changes consist primarily of expanding discussion on various tools and techniques within the Quality Management processes. Figure 8-2 on IPECC and PDCA Cycles in Relation to QA, QC, and COQ, was added to illustrate the fundamental relationships between quality assurance, quality control, and cost of quality to the Plan-Do-Check-Act and Initiate-Plan-Execute-Control-Close models. A new input was added for the Plan Quality Management process to better tie the requirements gathered during the Collect Requirements process to the overall quality planning for the project. More emphasis was placed on the basic quality management tools used in managing project quality. New figures were added to better summarize the seven basic quality tools and the seven quality management and control tools. Some inputs and outputs were renamed for several processes to support consistency between the various project management processes. Inputs and outputs were adjusted for several processes to reflect the new model of project data and information flow during the execution of project work.

The following table summarizes the Section 8 processes:

Table X1-5. Section 8 Changes

Fourth Edition Sections	Fifth Edition Sections
8.1 Plan Quality	8.1 Plan Quality Management
8.2 Perform Quality Assurance	8.2 Perform Quality Assurance
8.3 Perform Quality Control	8.3 Control Quality

X1.17 Section 9—Project Human Resource Management Changes

No significant changes were implemented in project management processes contained within this section. The Human Resource Planning process was renamed Plan Human Resource Management to support consistency in naming the processes that create the subsidiary plans. Changes consist primarily of some added or modified inputs, tools and techniques, and outputs, and the replacement of project management plan by human resource plan as an input of processes 9.2 Acquire Project Team, 9.3 Develop Project Team, and 9.4 Manage Project Team for consistency with processes in other Knowledge Areas. The definitions for Plan Human Resource Management, Acquire Project Team, and Develop Project Team were updated to better align with the details of these processes. Some inputs and outputs were renamed for several processes to support consistency in how information flows between the various project management processes.

The following table summarizes the Section 9 processes:

Table X1-6. Section 9 Changes

Fourth Edition Sections	Fifth Edition Sections
9.1 Develop Human Resource Plan	9.1 Plan Human Resource Management
9.2 Acquire Project Team	9.2 Acquire Project Team
9.3 Develop Project Team	9.3 Develop Project Team
9.4 Manage Project Team	9.4 Manage Project Team

X1.18 Section 10—Project Communications Management Changes

Information about stakeholder management was moved from Section 10 to a new Knowledge Area for Stakeholder Management. The Plan Communications process was renamed Plan Communications Management to support consistency in naming the processes that create the subsidiary plans. The processes for Distribute Information and Report Performance were reworked to clear up confusion between these processes and their overlap with processes for Control Scope, Control Schedule, and Control Cost. The processes were refocused toward the activity of communication as performed in projects, considering more the process of communicating rather than the intent or desired outcome of the message with emphasis on planning for the communications needs of the project, collecting, storing, and disseminating project information, and monitoring overall project communications to ensure its efficiency. The process names were changed to Manage Communications and Control Communications. The definitions for Plan Communications Management, Manage Communications, and Control Communications were updated to reflect these changes. Some inputs and outputs were renamed for several processes to support consistency between the various project management processes. Inputs and outputs were adjusted for several processes to reflect the new model of project data and information flow during the execution of project work.

The following table summarizes the Section 10 processes:

Table X1-7. Section 10 Changes

Fourth Edition Sections	Fifth Edition Sections
10.1 Identify Stakeholders	Moved to 13.1
10.2 Plan Communications	10.1 Plan Communications Management
10.3 Distribute Information	10.2 Manage Communications
10.4 Manage Stakeholder Expectations	Moved to 13.3
10.5 Report Performance	10.3 Control Communications

X1.19 Section 11—Project Risk Management Changes

No significant changes were implemented in project management processes contained within this section. The Monitor and Control Risks process was renamed Control Risks to support consistency in naming the various controlling processes. Changes were made to move the emphasis away from the term “positive risks” toward “opportunity” to better align with the feedback from the project management community. Text was added to expand upon the concepts of risk attitude, risk appetite, risk tolerance, and risk thresholds. Other changes consist primarily of cleaning up text, incorporating feedback, and aligning inputs and outputs with changes from other Knowledge Areas. Some inputs and outputs were renamed for several processes to support consistency between the various project management processes. Inputs and outputs were adjusted for several processes to reflect the new model of project data and information flow during the execution of project work.

The following table summarizes the Section 11 processes:

Table X1-8. Section 11 Changes

Fourth Edition Sections	Fifth Edition Sections
11.1 Plan Risk Management	11.1 Plan Risk Management
11.2 Identify Risks	11.2 Identify Risks
11.3 Perform Qualitative Risk Analysis	11.3 Perform Qualitative Risk Analysis
11.4 Perform Quantitative Risk Analysis	11.4 Perform Quantitative Risk Analysis
11.5 Plan Risk Responses	11.5 Plan Risk Responses
11.6 Monitor and Control Risk	11.6 Control Risks

X1.20 Section 12—Project Procurement Management Changes

The Plan Procurements process was renamed Plan Procurement Management to support consistency in naming the processes that create the subsidiary plans. The Administer Procurement process was renamed Control Procurements to support consistency in naming the various controlling processes. Other changes consist primarily of cleaning up text, incorporating feedback, and aligning inputs and outputs with changes from other Knowledge Areas. Some inputs and outputs were renamed for several processes to support consistency between the various project management processes. Inputs and outputs were adjusted for several processes to reflect the new model of project data and information flow during the execution of project work.

The following table summarizes the Section 12 processes:

Table X1-9. Section 12 Changes

Fourth Edition Sections	Fifth Edition Sections
12.1 Plan Procurements	12.1 Plan Procurement Management
12.2 Conduct Procurements	12.2 Conduct Procurements
12.3 Administer Procurements	12.3 Control Procurements
12.4 Close Procurements	12.4 Close Procurements

X1.21 Section 13—Project Stakeholder Management Changes

In keeping with the evolution of thinking regarding stakeholder management within projects, a new Knowledge Area was added addressing Project Stakeholder Management. Information on stakeholder identification and managing stakeholder expectations was moved from Section 10 on Project Communications Management to this new Knowledge Area to expand upon and increase the focus on the importance of appropriately engaging project stakeholders in the key decisions and activities associated with the project. New processes were added for Plan Stakeholders Management and Control Stakeholders Engagement. Some inputs and outputs were renamed for several processes to support consistency between the various project management processes. Inputs and outputs were adjusted for several processes to reflect the new model of project data and information flow during the execution of project work.

The following table summarizes the Section 13 processes:

Table X1-10. Section 13 Changes

Fourth Edition Sections	Fifth Edition Sections
10.1 Identify Stakeholders	13.1 Identify Stakeholders
	13.2 Plan Stakeholder Management
10.4 Manage Stakeholders Expectations	13.3 Manage Stakeholder Engagement
	13.4 Control Stakeholder Engagement

X1.22 Glossary

The glossary of the *PMBOK® Guide* – Fifth Edition has been expanded and updated to include those terms within the *PMBOK® Guide* that need to be defined to support an understanding of the document's contents:

- Clarify meaning and improve the quality and accuracy of any translations;
- Eliminate terms not used within the *PMBOK® Guide* – Fifth Edition; and
- Ensure terms align and harmonize with the terms in the *PMI Lexicon* and other key PMI standards.

X1.23 Data Flow Diagrams

The data flow diagrams for all project management processes were cleaned up and updated to remove inconsistencies and ensure each diagram accurately reflects the inputs and outputs associated with a given process.

APPENDIX X2

CONTRIBUTORS AND REVIEWERS OF THE *PMBOK® GUIDE*—FIFTH EDITION:

PMI volunteers first attempted to codify the Project Management Body of Knowledge in the *Special Report on Ethics, Standards, and Accreditation*, published in 1983. Since that time, other volunteers have come forward to update and improve that original document and contribute to this globally recognized standard for project management, PMI's *A Guide to the Project Management Body of Knowledge (PMBOK® Guide)*. This appendix lists, alphabetically within groupings, those individuals who have contributed to the development and production of the *PMBOK® Guide – Fifth Edition*. No simple list or even multiple lists can adequately portray all the contributions of those who have volunteered to develop the *PMBOK® Guide – Fifth Edition*.

The Project Management Institute is grateful to all of these individuals for their support and acknowledges their contributions to the project management profession.

X2.1 *PMBOK® Guide—Fifth Edition* Core Committee

The following individuals served as members, were contributors of text or concepts, and served as leaders within the Project Core Committee:

The following individuals served as members, were contributors of text or concepts, and served as leaders within the Project Core Committee:

Dave Violette, MPM, PMP, Chair
Joseph W. Kestel, PMP, Vice Chair
Nick Clemens, PMP (Sections 3 and 4 Lead)
Dan Deakin, PMP (Sections 11 and 12 Lead)
Theofanis C. Giotis, PMP, PMI-ACP (Sections 1 and 2 Lead)
Marie A. Gunnerson, (Sections 6 and 7 Lead)
Vanina Mangano, PMP, PMI-RMP (Integrated Content and Change Control Lead)
Mercedes Martinez Sanz, PMP (Sections 5 and 8 Lead)
Carolina Gabriela Spindola, PMP, SSBB (Quality Control Lead)
Kristin L. Vitello, CAPM, Standards Project Specialist

X2.2 *PMBOK® Guide—Fifth Edition* Subcommittee

The following individuals served as contributors of text or concepts and as leaders of the Project Subcommittee:

Matthew B. Anderson, PMP, PMI-ACP (Section 4 Leader)
Gilbert B. Asher, MBA, PMP (Data Flow Working Group Leader)
Brad Bigelow, PMP, MSP (Section 2 Leader)
Cecilia Boggi, PMP (Section 9 Leader)
Bernardo O. Bustamante, PE, PMP (Section 1 Leader)
Akshata Karanth, PMP (Section 6 Leader)
David L. Keeney, PMP, CTT+ (Section 8 Leader)
David Kramer (Section 12 Leader)
Karthikeyan Kumaraguru MS, PMP (Section 11 Leader)
Mary-Elizabeth Larson, PMP, CBAP (Section 5 Leader)
Charles J. Lesko, Jr., Ph.D., PMP (Section 10 Leader)
Claudia Alex Morris, MBA, PMP (Editorial Leader)
John M. Nevison (Section 7 Leader)
M.K.Ramesh, BE, PMP (Section 3 Leader through 6/2011)
Krupakar Reddy, PMP, PRINCE2 Practitioner (Section 3 Leader)
Yad Senapathy (Section 4 Leader through 6/2011)
Anca E. Slușanschi, MSc, PMP (Section 13 Leader)

X2.3 Significant Contributors

In addition to the members of the Project Core Committee and Subcommittee, the following individuals provided significant input or concepts:

George F. Burton MBA, PMP
Tammy Clark
Joel R. Erickson, MAcc, PMP
Stanisław Gasik, PhD
Ashok Jain, PMP, CSM
Andrea Pantano, PMP
Federico Roman Demo, PMP, ITIL
Anthony Tsui, MIT, PMP
Jennifer L. Walker, PMP

X2.4 *PMBOK® Guide—Fifth Edition* Content Committee

The following individuals were contributors of text or concepts and provided recommendations on drafts of the *PMBOK® Guide—Fifth Edition*:

Humayun Akhtar, PE, PMP	Puja Kasariya, PMP
Mark O. Alexander, P.Eng, PMP	Khalid Ahmad Khan, PE, PMP
Miguel Angel Hernandez Ayala, MBA, PMP	Terri Herman Kimball, PMP
Katherine A. Barnoski, PMP, CPCP	Vijay Kumar
Sameer S. Bendre, PMP, CSM	Gaspar Pacheco Leal, PMP
Manuela Borlovan	Nguyen Long Son, PMP, PMI-RMP
Hector E. A. Boye, MSc, PMP	Debra J. Lovelace, PMP
Carlos M. Brenes, MPM	Tom Magee, MBA, PMP
Kevin Brennan, PMP, CBAP	Ahsan Maqbool, PMP, PMI-RMP
Melissa F. Bull, PMP	Conrado Morlan, PgMP, PMP
Guido Caciagli B., PMP	Tilden Moschetti
Jesus Mario Garcia Cano, PMP	Jacob Kottackal Ninan
Ramesh Chandak	Abdul Nsubuga
Carol Dekkers, PMP, CFPS	Reuben Oshomah, MSc, PMP
Wayne D. Ellis, PE, PMP	Marcus S. Parker Sr., PMP
Andrés Falcón, MBA, PMP	Sergio A. Peñaloza, PMP
Anna Maria Felici, PMP, CMC®	Ute Riemann, MBA, MCS
Sachin Ghai, PMP	Nick Riordan, MBA, PMP
Juan Carlos González, PMP, ITIL	Shivkanth V. Rohith, PMP, PMI-ACP
Mike Griffiths, PMP, PMI-ACP	Bruce Schwickrath, PMP, LSS-MBB
Joseph Gruber, PMP, CAPM	Kishankumar J. Solanki
Sharnikya F. Howard, MBA, PMP	Tejas V. Sura, MS, PMP
Harold S. Hunt, PMP	Federico Vargas, PMP, MPM
Suhail Iqbal, PgMP, PMP	Srikanth Victory
Rajan T. Janjani, PMP, ITIL Expert	Himanshu Shripad Warudkar, PMP, ITIL
Chandrashekhar S. Joshi, PMP, Chartered Engineer	S. K. Steve Wong, PMP, CMA

X2.5 Reviewers:

X2.5.1 SME Review

In addition to the members of the Committee, the following individuals provided their review and recommendations on drafts of the standard:

Stephen Kwasi Agyei, PMP, LLM
 Lavanya Arul, PMP, PMI-RMP
 Ernest Baker, PMP, PRINCE2 Practitioner
 Mamoun Besaiso, CE
 James C. Bradford, Jr., PMP
 Damiano Bragantini, PMP
 Georgeta Brehoi, PMP
 Peter Brown
 Andrea Caccamese, PMP, Prince2 Practitioner
 Panos Chatzipanos, PhD, PE
 Jared Curtis, PMP
 Mario C. Delvas, MBA, PMP
 Dipti Desai, PMP
 Lakshmi Dhruvarao, PMP, CSM
 George Diakonikolaou, PhD, PMP
 Peter Dimov, PMP, CBM
 Richard Egelstaff, PMP, MBA
 Charles T. Follin, PMP
 Prabhat Garg, PMP
 Vivek Goel, PMP, CSM
 Mustafa Hafizoglu
 Dr. Sheriff Hashem, PhD, PMP
 David A. Hillson, PhD, PMI Fellow
 Christine Hoffman
 Hiroto Horio, PMP
 David T. Hulett, PhD
 Poornaselvan Jeevanandam
 Gregory I. Jepson
 Kazuo Kawai, PMP

Konstantinos Kirytopoulos, PhD, PMP
 Adrian W. Lovel-Hall, PMP, PMI-RMP
 Thomas F. McCabe, PMP, CSSMBB
 Harold “Mike” Mosley, Jr., PE, PMP
 Daud Nasir, PMP, LSSBB
 Alexandre Vieira de Oliveira, MBA, PMP
 Sneha V. Patel, PMP
 Richard Perrin
 Walter Plagge, MBA, PMP
 Marlene Derian Robertson
 Fernan Rodriguez, PMP
 Tres Roeder, MBA, PMP
 Guy Schleffer, MBA, PgMP
 Nitin Shende, PMP, CSM
 Nagendra Sherman, PMP
 J. Greg Smith
 Cyndi Snyder, PMP, EVP
 Gere V. Streun, PMP, PMI-ACP
 Jurgen Sturany, PMP
 Yasuji Suzuki, PMP
 Shoji Tajima
 Yvonne Tan EY, PMP
 Gerhard J. Tekes, PMP, PMI-OPM3
 Certified Professional
 Biagio Tramontana, Eng., PMP
 Thomas M. Walsh, PMP
 Juanita M. Woods, PMP, PgMP
 Ronaldo Zanardo, CAPM
 Heinz Zimmermann, PMP

X2.5.2 Member Advisory Group (MAG) Review

The following individuals served as members of the PMI Standards Program Member Advisory Group and voted on the final draft of the *PMBOK® Guide* – Fifth Edition:

Monique Aubry, PhD, MPM
Chris Cartwright, MPM, PMP
Laurence Goldsmith, PMP
Paul E. Shaltry, PMP
Cyndi Snyder, MBA, PMP, EVP

X2.5.3 Consensus Body Review

The following individuals served as members of the PMI Standards Program Consensus Body and voted on the final draft of the *PMBOK® Guide* – Fifth Edition:

Monique Aubry, PhD, MPM
Nigel Blampied, PE, PMP
Nathalie Bohbot, PMP
Dennis L. Bolles, PMP
Peggy Brady
Chris Cartwright, MPM, PMP
Sergio Coronado, PdD.
Andrea Demaria, PMP
John L. Dettbarn, Jr., DSc, PE
Charles T. Follin, PMP
Laurence Goldsmith, MBA, PMP
Dana J Goulston, PMP
Dorothy L. Kangas, PMP
Thomas Kurihara
Timothy MacFadyen
David Christopher Miles, CEng, OPM3-CC
Harold “Mike” Mosley, Jr., PE, PMP
Mike Musial, PMP, CBM
Eric S. Norman, PgMP, PMP
Deborah O’Bray, CIM (Hons)

Nanette Patton, MSBA, PMP
 Crispin (“Kik”) Piney, BSc, PgMP
 Michael Reed, PMP
 Chris Richards, PMP
 Paul E. Shaltry, PMP
 Jen L. Skrabak, MBA, PMP
 Matthew D. Tomlinson, PgMP, PMP

X2.5.4 Final Exposure Draft Review

In addition to the members of the Committee, the following individuals provided recommendations for improving the Exposure Draft of the *PMBOK® Guide*—Fifth Edition:

Javed A. Abbasi, MBA, PMP	PMP, MSc (Mech.)	J. Balamurali, PMP
Klaus Abert	Anwar Ali, MBA, PMP	Federica Ballone, PMP
Biju B. Abraham, PMP	Allam V V S Venu, PMP	Manuel F. Baquero V., MSc, PMP
Mohammad I. Abu Irshaid, PMP	Barnabas Seth Amarteifio,	Brent R. Barton
Mohammad Adel, PMP	PMP, ITIL	Anupam Baruah
Yaser Afaneh, MSCE, PMP	Yousif Amin, PMP	Olaf Baumgartner, PMP
Eng. Ahmed Taha, MBA, PMP	Andy Anderson, MA, PMP	Iain Begg, PMP
Mounir Ajam	David Angelow, MBA, PMP	Laura Benedetti
Phill C. Akinwale, MSc, PMP	Luciano Antonucci	Wayne F. Best
Mfon D. Akpan, MBA, PMP	Mark A. Archer, PhD, PMP	Harwinder Singh Bhatia,
Mobasher Abdu Al-Asmry,	Ondiappan Arivazhagan “Ari”	PMP, CSM
CE, KSA	PMP, PMI-RMP	Pius Bienz, PhD, PMP
Homam Al khateeb, PMP,	Wisdom Kwasi Asare-	Jean Binder, PMP
PMI-RMP	Amegashie	Nigel Blampied, PE, PMP
Ahmad Al-Nahar, MBA, PMP	Babissakana, PMP	Michael P. Bomi, BSc, PMP
Melad Alaqra, PMP	Mohamed A. Badie, PMP,	Raúl Borges, PMP
José Rafael Alcalá Gómez,	Prince2 Practitioner	Farid F. Bouges, MSc, PMP
MBA, PMP	Ammar N. Baidas, PgMP, PMP	Lynda Bourne, DPM, FAIM
Martin Alemán Valdés, PMP	Kamal Bajaj, PMP, PGDBA	Joao Carlos Boyadjian,
Mohammed Faiq Al-Hadeethi,	Jehad J. Baker, PgMP, PMP	MSc, PMP

Didier Brackx, PMP	Angel R. Chourio, PMP	Serge Dolivet, PMP
Jim Branden, MBA, PMP	Eric Christoph, PMP, EVP	Bhushan Dongare
Wayne R. Brantley, MEd, PMP	Rose M. Clark, PMP	R. Bernadine Douglas, MS, PMP
Ralf Braune, PMP	Rogério L. Clavello, PMP	Xinhua Du
Tamela J. Brittingham, PMP	Xavier Clerfeuille, MSc, SSL	Arun Dubagunta
Jerry Bucknoff, MBA, PMP	Black Belt	Stephen Duffield, MPM, CPPD
Syed Asad Hasnain Bukhari, MBA (MIS), PMP	Paul Converti, PMP, CISSP	Pradip Kumar Dwevedi, PMP
Jeffrey S. Busch, PMP	Mario Coquillat de Travesedo, PMP	Hany A. Elhay, PMP
Mario Castro Caballero	Franco Cosenza, PE, MScEE	Bilal M. El Itani, MBA, PMP
Anthony Cabri, PMP	Jeremy Coster, PMP	Abdurazag Elkhadrave
Andrea Caccamese, PMP, Prince2 Practitioner	Raymond Covert	William Ernest, MPM, PMP
Roberto A. Cadena Legaspi, PMP	Holly Cowe	Dmitry A. Ezhov, PMP
Jacob Calabrese, CSP, CBAP	Adriano José da Silva Neves, MSc, PMP	Leandro Faria, PMP, PMI-ACP
Maria Cardullo	William L. (Bill) Dam, PMP, CPG	Daniel Fay, PMP
James F. Carilli, PgMP, PMP	Joseph W. Daniel, PMP	Madhu Fernando, DBA, PMP
Christopher W. Carson, PMP, CCM	Richard Gary Daniels	Jesse Fewell, PMP, CST
Angela M. Cason, PMP	Mohamed Daoud	Claudia Fiallo, PMP
Ralph Celento	Russell W. Darnall, DM, PMP	John C. 'Buck' Field, MBA, PMP
Rebecca Cervoni, PMP	Fariborz Davarpanah, MBA, PMP	Robinson Figueroa, MS, PMP
Bruce C. Chadbourne, PgMP, PMI-RMP	Luiz Guilherme de Carvalho	David Foley, MBA
Kameswaran	Elisa De Mattia	Sandra Fonseca-Lind
Chandrasekaran, PMP	P.H. Manjula Deepal De Silva, BSc, PMP	Scott D. Freauf, PMP, IPMA-C
Theodore Jiyon Chang	Vijay Deshpande	Sakae Fujino
Ramesh Chepur, PMP, PRINCE2 Practitioner	Salvatore Di'orio	Yoichi Fukuhara, PMP
Subrahmanyam VN Chinta	George Diakonikolaou	Nestor C. Gabarda Jr., ECE, PMP
PMP, CSM	John H. Dittmer, VI, CISSP- ISSMP, PMP	Luca Gambetti, PMP, CFPS
Marcin Chomicz, MBA, PMP	Marcelo Sans Dodson, PMP, MPM	Gerardo A. Garavito F, PMP, PMI-ACP
Abhishek Chopra	Roland Doerr, MBA, PMP	Jose Eduardo Motta Garcia, MBA, PMP
		Jorge Garcia Solano, PMP, MPM

Sergio Garon, MS	Abdulrahman M Hassan, MSc	Johannan ‘Johnny’ Jhirad, B.
Jay D. Gassaway, PMP, PMP-SP	Gregory T. Haugan, Sr.,	Tech (IIT Bombay)
Michael J. Gauthier, MA, CPM	PhD, PMP	Marco Antonio Jimenez,
Darline Georges	Larry J. Hawkins, DSc, PMP	MBA, PMP
Soumajit (Sam) Ghosh, PMP,	Susumu Hayakawa, PMP	Jaime Jiménez Ayala, PhD, PMP
PhD Candidate	Kym Henderson, RFD	Tony Johnson, PgMP, PMP
Carl M. Gilbert, PMP, Cert OPM3	MSc (Comp)	Fayez Jolani, MBA, PMP
Professional	Robert Hierholtz	Michele J. Jones, PMP
Peter James Gilliland, PMP	Robert N. Higgins V, PMP	Yves Jordan, PMP
Sulema de Oliveira Barcelos	Danny N. Hinton, PMP	Chandrashekhar S. Joshi, PMP,
Gobato, MSc, PMP	Shirley P. Hinton, PMP	Chartered Engineer
Emily Godinet Lounge, PMP	Hisashi Hirose, PMP	Rameshchandra Joshi
Peter Goldberg	Jack J. Holmes, PMP	Donaliya K. Porter, MBA, MPM
Andrés F. Gómez, MSc, PMP	Keith D. Hornbacher, MBA	SS Kanagaraj, PMP, ITIL
Guillermo Gomez Hdez., CSM	Tim Hornett, PMP	Edwin J. Kapinus, PE, PgMP
José Abranches Gonçalves,	Christina M. House, PMP, EMBA,	Madhavi Karanam, MBA
MSc, PMP	Seth Huckabee	Heinrich Karageorgou,
Himanshu Kumar Goswami	Robert F. Hull, PE, PMP	MBA, DBA
Jean Gouix, Eng, PgMP, PMP	Guillermo A. Ibañez, PMP, ITIL	Naoki Kasahara, PMP
Gary J. Graham, CISM, CISSP	Shuichi Ikeda, PMP	Ramakrishna Kavirayani, PMP
Charlie Green, PMP	Hemant Israni, PMP, PMI-RMP	Kenichi Kawamata, PMP
Roy C. Greenia, MPM, PMP	Vladimir Ivanov, IPMA-B	Babatunde Oluwayomi Kayode,
Salomon Pineda Guerrero	Assessor, ITIL Expert	MS ProjM, MSc(PM)
Pier Luigi Guida, PgMP, PMP	Vidya Iyer, PMP	Tarig A. Khalid, PMP, CBAP
Lakshmeesha T. Gundurao,	Can Izgi, PMP	Adil Khan
PMP, CSM	Elaine T. Jackson, BS, PMP	Muhammad Ehsan Khan, PhD,
Guo Ming-Hui (MARS), PMP	James M. Jackson, PMP, FLMI	PgMP, PMP
Kapil Gupta, PMP	Rajesh Jadhav, PgMP, PMI-RMP	Nader Khorrami Rad, PMP
Edward Hall, PMP	Rebecca Jahelka, PMP	Mangesh A Khunte, PMP,
Noha Hamdy	Gagan Jain, MBA, PMP	PMI-ACP
Sharad S Harale, MBA, PMP	Don R. James, PMP	Mostafa Kilani
Simon Harris, PMP, D4®	Vicki James	Athens Koliass, PMP, MPM
Accredited	Chandra Shekar Jayanna, PMP	Walter Kriegl, PMP

Srikanth Krishnamoorthy, PMP, PGDSA	Anand Lokhande, PMP	Rashmi Menon
Kannan Krishnan	Alberto J. Lopez, PMP	Mohammed M'hamdi, PMP
Casimer "Casey" Kroll, PMP, MASc	Samuel López González de Murillo, PMP	Joachim Modern, PMP
Gustavo Krowczuk, PMP	Zheng Lou, MBA, PMP	Megat Ahmad Zainuri B. Mohamed, PMP
Devesh Kumar, PMP, PMI-ACP	Sérgio Lourenço, PMI-RMP, PMP	Mannan Mohammed, PMP, PEng
L. Senthil Kumar, PMP	Hugo K. M. Lourenço, PMP	Haitham K. M. Mokhtar, BSc, PG Dip
Pavan S. Kumar, PMP	Robert A. Lyell, PMP	Andres Molano Trujillo
Raghu Kumar	Frederick G. Mackaden, MBA, PMP	Marshciene Hendrix Moor, MBA, MS
Vladimir Kupershteyn, PhD, PMP	Engr. Sangu Maha Rajan, BTech	Lacheta Moore
Thomas M. Kurihara	Abhijit A. Maity, PMP	Carlos Morais
Puneet Kuthiala, PMP, CGEIT	Richard Maltzman	John Morck, Med, PMP
Massimo La Rosa, PMP	Anthony Mampilly, PMP	Harold "Mike" Mosley, Jr., PE, PMP
Thierry Labriet, PMP, IPMA-B	Kenneth Manahl	Saradhi Motamarri, MTech, PMP
Rangarajan Lakshminarasimhan, PMP	Ammar Mango	Henrique Moura, PMP
Arun Lal	David Mantle, PMP	Nathan M. Mourfield, MBA, PMP
Elixender Lamprea León, PE-ITIL, MSc IT	Len Marchese, PMP	Hazim Muhssin
Hagit Landman, PMP, PMI-SP	Daniel Marigliano	Kristin Munro
Ayotunde O. Lawal, PMP, CAPM	Shobhana M., BTech, Prince2	Mike Musial, PMP, CBM
Roberta Lawrence, BAppMgt (Project Management) PMP	Antonio Marino, PMP, PMI-ACP	Khalid M. Musleh, PMP, ISO 9001 LA
S. Douglas Leard, PMP, ACP	Tom Mastal, PMP, CSM	Arul SP Muthupandian
Oliver F. Lehmann, PMP, CLI-CP	Flávio Matsuyama, PhD	Amir Naderi, Msc, PMP
Ginger Levin, PhD, PgMP, PMP	Vincent McGevna, PMP, PRINCE2 Practitioner	Basab Nandi
Jean-Pierre Lhomme, PMP	Jon McGlothian, MBA, PMP	Sergio Nascimento
Jian Liang	Alan McLoughlin, BE, MPM	Faig Nasibov, PMP
Kanak Limbu, PMP, ITILV3	Suzette A. McNaught, MBA, PMP	Mthokozisi Ncube, MSc, PMP
Frank MC Lin	Peter Berndt de Souza Mello, SpS, PMI-SP	Ta-Tianna K. Nealy, PMP, RMP
Marco Antonio L. Lo Visco, MBA, PMP	Yan Bello Méndez, PMP	Shashank Neppalli, PMP
Lohokare	Katia M. Méndez Madrigal, MAP, PMP	Nghi M. Nguyen, PhD, PMP
	Ernst Menet, PMP	Thuthuy C. Nguyen, PMP

Tri Hue Nguyen, PMP	Richard J Perrin, PMP, MBB	Gustavo De Abreu Ribas, PMP
Idika U Ngwobia, MSc, PMP	D. John Peter, PMP	Andriele Ribeiro, MSc, PMP
Jonathan Nickerson, PMP	Lachlan Peter, CPEng, PMP	Juan Carlos Ribero Gomez, PMP
Praveen K. Nidumolu, PMP, CSM	Massimo Pica, Brig. Gen.(ret.)- Italian Army, Dr (Eng)	Richard A. Rodberg, PMP
Eric Nielsen, PMP	Joseph Pignato	Bernard Roduit
Jeffrey S. Nielsen, PgMP, PMP	Raj Pillai, PMP, MIFireE	David Roe, PMP
Sanjay Nivargikar	Teresita L. Pineda, PMP, LEED AP	Brandon Joseph Rogers, PMP
Takuji Noguchi, PMP	Crispin (“Kik”) Piney, BSc, PgMP	Yvette Roserie, PMP
Michael Nolle	Jose Angelo Pinto, PMP, OPM3 CC	Cecile T Ross, PMP
Alireza Noordoust Behtouei	Alan L. Plastow, PMP, MAT	Mohamed Saad
Fernando Nunes de Oliveira, PMP, PMI-SP	Fredric L. Plotnick, PhD, PE	Kumar Sadasivan, PMP
Henry Lapid Nuqui, PEE, PMP	Shaligram Pokharel, PhD, REng	Mihail I.E. Sadeanu, PhD, PMP
Kevin T. O’Brien, PEng, PMP	George E. Porter, MBA, PMP	Keiko Sakagami, PMP
Peter O’Driscoll, PMP	Marcus Possi, MBA-FGV, SpS	Eng. Salem Mahaboob Saliha Sheriff MBA, PMP
Dayo Odunlami, MBA, PMP	Edwin A. Provencal, MBA, PMP	Christian Q. Salvaleon
Siobhan-Louise O’Keefe	Naseer Pervaz Qureshi	Angela M. Sammon, PMP
Bayonle Oladoja, mnse, PMP	Norman Radatz, PMP	Ranga Sarangan, MBA, PMP
Neil Olshansky	João Ramalho, PMP	Vikas Sarin, PMP, ME(SS)
Johnson O. Omosule, Bsc	S. Ramani, PgMP, PMP	Kyoichi Sato, PMP
Thomas Q. O’Rourke, PMP, PMI-RMP	Phalguna K Ramaraju, PMP, PMI-ACP	Sara Sattar, PMP
Venkateswar P. Oruganti, PMP, FIETE	Rajkumar Ramaswamy, P Eng, PMP	Anatoliy A. Savin, PMP
Mahmoud Assaad Othmane, PMP, CIPM	M.K.Ramesh, BE, PMP	Doina T. Scafaru, PMP
Maksym Ovsianikov, PMP	Surdev Randhawa	Danilo Scalmani, PMP
Hariyo D. Pangarso, MT, PMP	Raghunathan Rangapathy, PMP	Gary D. Schmitz, PMP
James W. Parcels	Madhavan S Rao , PMP	Martin R. Schneider
Sandro Pasini, MBA, PMP	Raju N Rao , PMP, Cert OPM3 Professional	William T. Schulz, PMP
Yadaiah Pathkula	Michael Reed, PMP	Ulrich Schumann, PMP
Marcello Patrese, PMP, PMC	Vicky Restrepo, PMP	Hemant Seigell, MBA, PMP
Dražen Penzar, PMP		Yoshiro Sekihara
		Dhruba P. Sen, PMP, CSDP
		Maharajan Skandarajah, PMP
		Shrenik Shah, PMP

Nitin Shende, PMP, CSM
 Kazuo Shimizu, PMP
 David Shirley, MBA, PMP
 Sandeep Shouche, PgMP, PMP
 Hilary Shreter, MBA, PMP
 Sameer Siddhanti, MSc, PMP
 Edson Silva
 Evandro Silva
 Fay Simcock
 Gurpreet Singh, MBA, PMP
 Ravi H. Singh, PMP
 Nabakishore Singha Y.,
 EMBA, PMP
 Rajesh Singla, PMP
 Darnell Singleton, PMP, MSPM
 Sumit Kumar Sinha, PMP
 Malik Skaljic, PMP, MBA
 Charles D. Smith, PMP
 J. Greg Smith
 Kenneth F. Smith, PMP, DPA
 Cyndi Snyder, PMP, EVP
 Pamela Soderholm, PMP
 Emad Eldin Soliman
 Wang Songping
 Mauro Sotille, PMP
 Frank Spiegel, PMP
 Babou Srinivasan, PMP
 Ravishankar Srinivasan, PMP
 Sriram Srinivasan, PMP,
 ITIL Expert
 Dennis E. Stevens
 Kevin Stokes
 Zendre Strother

Murali Sundararaju, PMP
 Yasuji Suzuki, PMP
 Sudhir Swamy, PMP
 Marcus Tabart, PMP
 Afif Tabsh, PMP
 Shoji Tajima, PMP, ITC
 Roberto Taraschi, PMP
 Isabella Taschetta, PMP
 Sunil Telkar, PMP, MIMA
 John G Terdik, PMP, CSM
 Carlos Tessore, PhD, PMP
 Riad Thalji, PMP
 Srinivasan Thiruvengadathan
 John B. Thomas, PMP
 Sal J. Thompson, MBA, PMP
 Ronald Togatorop, PMP
 Mark Tolbert, PMP
 Ricardo Torres
 Luis Eduardo Torres
 Calzada, PMP
 John T. Tracy, MBA, PMP
 Mario H Trentim, PMP, PMI-RMP
 Ankit M. Trivedi, MS, PMP
 Mahmoud M. Turkistani, PMP
 Bruce E. Turner, PhD, PMP
 Junichi Uchiyama, PMP
 Hafiz Umar
 Krishnakant T Upadhyaya, PMP
 Srikanth U.S., MS, PGCPM
 M. Fahad Usmani, PMP, PMI-
 RMP
 Ali Vahedi Diz, PgMP, PMP
 Richard E. Vail, PMP

Jorge Valdés Garcíatorres,
 PMP, ACB
 José Félix Valdez, PMP
 Tom Van Medegael, PMP
 Mårten van Rheinberg, PMP,
 PMI-ACP
 Stephan Vandevoorde, Ing.
 Ravi Vanukuru, B.E., PMP
 Lelio Varella, PMP
 Ricardo Viana Vargas, MSc, PMP
 Jouko Vaskimo, PMP, IPMA
 Level B
 Cynthia A. Vaughn, MBA, PMP
 Isabel Rosario Vega
 Palomino, PMP
 Vedananda V Venkata, MS, PMP
 Thierry Verlynde, MS, PMP
 Basskar Verma
 Aloysio Vianna Jr., PMP
 Jaime Videla, PMP
 Carlos Augusto Freitas,
 PMP, CAPM
 Tiziano Villa, PMP, CMC
 Jorge Archivaldo Villa, CE
 Ananth Vishakantiah, PMP
 Mangi Vishnoi, PMP, MIEAust
 Poonam Vishnoi, PMGTI
 Yiannis Vithynos PMP, PMI-ACP
 Atin Wadehra, MBA, PMP
 Paul Waits Jr., PMP, CPM
 Xiaojin Wang, PhD, PMP
 Patrick Weaver, PMP, FAICD
 Kevin R. Wegryn, PMP, MA

Stacia Weiner, PMP
Roger K. Weld, PE, PMP
Philip Wells PMP, CEH
Sean Whitaker, MBA, PMP
S. White
Rebecca A. Winston, JD
Stephen Wise, PMP

Sheng Jun Tony Wu, PMP
Wenyi Xiao, PMP
Chen YanJi, PMP
Clement C.L. Yeung, PMP
Masafumi Yoshizawa, PMP
Yong Yu
Ricardo T. Yugue, MSc, PMP

Azam M. Zaqzouq, MCT, PMP
Omran Mohamed Zbeida,
PMP, BSP
Bin Zhang
Salim Zid, PMP, LEED AP BD+C

X2.6 PMI Standards Program Member Advisory Group (MAG)

The following individuals served as members of the PMI Standards Program Member Advisory Group during development of the *PMBOK® Guide*—Fifth Edition:

Monique Aubry, PhD, MPM
Margareth F.S. Carneiro, MSc, PMP
Chris Cartwright, MPM, PMP
Terry Cooke-Davies, PhD
Laurence Goldsmith, PMP
Paul E. Shaltry, PMP
Cyndi Snyder, MBA, PMP, EVP
John Zlockie, MBA, PMP, PMI Standards Manager

X2.7 Harmonization Team

Karl F. Best, CAPM, CStd
Steve Butler, MBA, PMP
Folake Dosunmu, PgMP, OPM3
Randy Holt, MBS, PMP, Chair
Dorothy L. Kangas, PMP
Joseph W. Kestel, PMP
M. Elaine Lazar, AStd, MA
Timothy MacFadyen
Vanina Mangano
David Christopher Miles CEng, OPM3-CC
Eric S. Norman, PgMP, PMP
Michael Reed, PMP
Chris Richards, PMP
Jen L. Skrabak, MBA, PMP
Carol Steuer, PMP
Bobbie S. Underwood, PMP, PMI-ACP®
Dave Violette, MPM, PMP
Kristin Vitello, CAPM
Quynh Woodward, MBA, PMP
John Zlockie, MBA, PMP

X2.8 Production Staff

Special mention is due to the following employees of PMI:

Donn Greenberg, Publications Manager
Roberta Storer, Product Editor
Barbara Walsh, Publications Production Supervisor

X2.9 Contributors to Past Editions

X2.9.1 The *PMBOK® Guide*—Fourth Edition:

Cynthia Stackpole, MBA, PMP, Project Manager
 Karen Rasmussen Noll, Deputy Project Manager
 Murray Grooms, BA, PMP (Communications)
 Sandra Hyman (Chapter Coordinator)
 Joseph W. Kestel, PMP, MSIS (Chapter 3 and 5 Lead)
 Tom Malicki (Volunteer Lead, Front & Back Lead)
 Clifford W. Sprague, PMP (Volunteer Coordinator)
 Gerev V. Streun, CSQE, PMP (Chief Architect)
 Kristin L. Vitello, Standards Project Specialist

X2.9.2 Other Contributors:

Wayne F. Abba
 Ahmed Taha Abd El Hameed
 Ir Hj Ahmad Khairiri Abdul Ghani,
 Int PE, ASEAN Eng
 Klaus Abert
 Biju B. Abraham, PMP
 Ed Adelman, PMP
 Yasser Thiab Ali Afaneh
 Mohit Agarwal
 Upinder Aggarwal, PMP
 Eva D. Aimable
 Shigeru Akiba, PMP
 Phill C. Akinwale, PMP
 James E. Aksel, MS, PMP
 Neil F. Albert
 Mohammad M. Ali

Hussain Ali Al-Ansari,
 Eur Ing, C Eng
 Mohammed Abdulla Al-Kuwari,
 Eur Ing, PMP
 Graeme A. Allan,
 BSc(Hons), PMP
 Marcia de Almeida
 Wasel A. Al-Muhammad,
 MBA, PMP
 Noor Hamad Alnisif, PMP
 Fayez Mosaed Al-Talhi, PMP
 Alonso Loaiza A., PMP
 Barnabas Seth Amarteifio, PMP
 Ketal Amin, BB, PMP
 Alok N. Anadkat, BS, PMP
 P. Lingesh Ananth, PMP

Abel Andrew Anderson,
 CBM, PMP
 Chet R. Anderson, PMP
 Niels Erik Andersen, MSc CS
 Jagathnarayanan P. Angyan,
 FIE, CE
 Ondiappan Arivazhagan “Ari”,
 PMP, CSSBB
 Muhammad Waqar Asghar, PMP
 Syed S. Asghar, MSA, PMP
 Usman Asif, PMP
 Naing Moe Aung, PMP
 Shigeo Awamura
 Mike Awuah, MBA, PMP
 Tanin I. Ayabakan, MD, PMP

Jacklyn Ayoung-Chee, MBA, PMP
 Mahadhir Aziz, PMP
 Karthegesan B., MBA, PMP
 Rozinah Bachik, MSc (PM), PMP
 Ernest Baker, PMP
 Ramanan Balakrishna, PMP
 Sunil Bansal, PMP
 Ricardo do Rêgo Barros, PMP
 Patricia J. Bartl, PMP
 Nazir M. Bashir, PMP
 Herminia Bastos, PMP, CMC
 Mohammed Safi Batley, MIM
 Fred Beckmann, PMP
 Debra C. Bedford
 Julia M. Bednar, PMP
 Eric Berry, PMP
 Stephen Berté, PhD, PMP
 Mamoun A. Besaiso, CE
 Dale L. Beyer, MBA, PMP
 Christie Biehl, EdD, PMP
 Shantanu Bhamare, PMP
 Alok Bhaskar, MBA, PMP
 Kurmarao V. Bhavanasi, PMP
 Artur Bialy, PMP
 Craig Nicholas Blackford
 Rhonda R. Blevins, PMP
 Edward Bogak, MBA
 Dennis L. Bolles, PMP, LLC
 Stephen F. Bonk, PMP, PE
 Adolfo Borja, MBS, PMP
 Al Bornmann, PE, PMP
 Lyn Bos, MHA, MBA

Jean-Luc Boulanger, PMP
 Lynda Bourne, DPM, PMP
 Didier Brackx, EMS Prof, PMP,
 Robin G. Bradshaw, PMP
 Carlos Eduardo M. F. Braga, PMP
 Wayne R. Brantley, MS Ed, PMP
 Ralf Braune, PMP
 Michael C. Broadway, PMP
 Alex S. Brown, PMP IPMA-C
 Ian A. Brown, MBA, PMP
 Jerry L. Brown, PMP
 Joan Browne
 Jeannine Allison Bryan
 Pat Buckna, PMP
 Camper Bull, PMP
 Mitchell S. Burke, MS, MBA
 Janet P. Burns, PMP
 Kenny E. Burrow, PhD, PMP
 Bernardo O. Bustamante, PE, PMP
 John Buxton, PE, PMP
 Andrea Caccamese, PMP, PRINCE2 Practitioner
 Roberto Alejandro Cadena
 Charles Cain, PMP
 Teresa W. Calhoon, PMP
 Sergio A. Calvo, PMP
 Luis Eduardo Torres Calzada, MPM, PMP
 Franco Caron, PhD
 Alejandro M. Polanco Carrasco
 Chris Cartwright, MPM, PMP
 Brian L. Cassita

Roberto Castro
 William A Cather, PhD, PMP
 Roberto Celkevicius, PMP, ITIL
 Bruce C. Chadbourne, PMP, PgMP
 K. K. Chakraborty, PMP, BE
 Krishna Datta Nallani Chakravartula, MBA, PMP
 Ka-Keung Chan, PMP, MBA
 Paul E. Chaney, PMP
 Supriyo Chatterji, MCA, PMP
 Tony Tze Wai Chau, PMP, MAPM
 Noman Zafar Chaudry, PE, PMP
 Ashish Chawla, MS
 Zhen Cheng
 David Kwok Keung Chenung
 Ramesh Chepur, CSQA, PMP
 David K. Cheung, MSc, MBA
 Tomio Chiba, PMP
 Ananaba Marcellinus Chikwendu, MBA, PMP
 Hsing-Tung Chou, PhD
 Lung-Hung Roger Chou, PMP, MCT
 David Christensen
 Manuel Cisneros, MBA, PMP
 Douglas Clark
 Darrell S. Cleavenger, PMP
 Alexandre Coelho, PMP
 Richard J. Coffelt, PMP
 Brenda Connor, PMP
 Terry Cooke-Davies, PhD, FCMI
 Edmund H. Conrow, PhD, PMP

Betty Corbin, PMP
 John E. Cormier, PMP
 Mauricio E. Cornejo, PMP
 Anthony R. Corridore, PMP
 William T. Craddock
 Larry E. Criger, PE, PMP
 Darren D. Criglar, MLA, MA
 Jacqueline M. Cruit, PMP
 Mary Colleen Cullinan, PMP
 Michael J. Cunningham, PMP
 Craig Curran-Morton, MA, PMP
 Robert L. Cutler, PMP
 Barbara Y. DaCosta, MPA, PMP
 Venkatesh Dakshinamurthy
 Claudio D’Arcangelo, PMP
 Claudio Da Rold, PMP
 Anirban Das, PMP
 Venkateswarlu B. Dasigi,
 PhD, PMP
 Patricia A. David-Gentsch
 Allan Edward Dean, MBA, PMP
 Jim Delrie, PE, PMP
 Madhavi Desai, MS, PMP
 Rahul P. Deshpande
 Anita Dhir, PMP
 Laurie Diethelm, CAPM
 David Dominguez
 Nick Doralp, PMP, ECM
 George R. Dorer, MBA, PMP,
 Bernadine Douglas
 Nicolas Douliez
 Nigel O. D’Souza, PMP, ITIL
 John A. Dullnig, PMP
 Francine J. Duncan, MIEEE, PMP
 Azra Duric, PMP
 Teresa Duvall, PMP, CDR
 Phillip Dyer, PMP
 G. Ebynayagam
 Susan Holly Edelman, PMP
 Judith A. Edwards, PhD, PMP
 Paul J. Egan
 Tarek El-Misalami, PhD, PMP
 Waleed M. ElToukhy, PMP
 Ramon Espinoza, PMP
 Brian M. Evans, PMP
 Peter Ewart-Brookes, PMP
 Steven L. Fahrenkrog, PMP
 Bruce E. Falk, PMP
 John L. Fallon, PMP
 Giovanni Fanduiz, MSc, PMP
 Sabeeh U. Faruqui,
 BE Elect, PMP
 Kathleen M. Federici,
 MEd, CAPM
 AnnaMaria Felici, PMP, CMC
 Luis Cláudio Tavares
 Fernandes, PMP
 Marcelo B. Ferreira
 Ann Marie Ficarra, PMP
 Michael H. Fisher, MSPM, PMP
 Matthew J. Fiske, PE, PMP
 Cheryl Fitzgarrald, PMP
 Edgardo J. Fitzpatrick, PMP
 Martin Flank, MBA, PMP
 Joel E. Fleiss, PMP
 Quentin W. Fleming
 Gloria Elena Folle Estrada
 Charles T. Follin, PMP
 Dean J. Fragos
 Amanda Freitick
 Scott D. Freauf, PMP
 Mark R. Friedman, CISA, PMP
 Scott J. Friedman, PMP
 Andrew H. Furber, PMP, PRINCE2
 W. Anders Fusia, PMP
 Ravindra Gajendragadkar, PMP
 Sharyn H. Gallagher, EdD, PMP
 Xue Gang (Gabriel), PMP, QSLA
 George F. Garas, MBA
 Jose Eduardo Motta Garcia,
 MBA, PMP
 Anand Swaroop Garg
 Stanislaw Gasik
 Jay D. Gassaway
 David P. Gent, CEng, PMP
 Mitchlyn Gentry, MISM
 Joseph Sanju George
 Subir Ghosh, PMP
 Carl M. Gilbert, PMP, OPM3A/C
 Peter James Gilliland, PMP
 Theofanis Giotis, MSc, PMP
 Fernando Hurtado Giraldo
 Jonathan Glaser, PhD, PMP
 Sulema de Oliveira Barcelos
 Gobato, MSc, PMP
 Joelle A. Godfrey, PMP
 Vivek Goel, PMP
 Marshall Goldman, PMP
 Roger K. Goodman, PMP

Jean Gouix, Eng, PMP
 Priyesh Gopalakrishnan
 Derek R. Grant, BSc, PMP
 Thomas J. Gray, PE, PMP
 Paul A. Green, BSc (Hons)
 Donn Greenberg
 Roy Greenia
 Stephen Grey, PhD
 Mireya Grieco, PMP
 Liz Grinzo, PMP
 Torben Grut, PMP
 Jeff Jianfei Gu, MBA, PMP
 Ruth Anne Guerrero, MBA, PMP
 Pier Luigi Guida, Ing, PMP
 Joy Gumz, CPA, PMP
 Marie Gunnerson
 Swati Gupta, PMP
 Raj Guttha
 Anne N. Gwankobe, PMP, CSSGB
 Mustafa Hafizoglu, PMP
 Edward Hall, PMP, CQM
 Matthew W. Handi, PMP
 John Haneiko, PMP
 Sharad S. Harale, PMP, MIM
 Kurt J. Harris, PMP
 Donna M. Harrison, PMP
 Akkiraju V. Harshavardhan, PMP
 Dr. Sheriff Hashem, PhD, PMP
 Mohamed Hassan, PMP, CSWP
 Lawrence Hattenburg, PMP
 Larry J. Hawkins, DSc, PMP
 Ernesto Yo Hayashi, MEng
 Jim Hayden, PMP

Gary R. Heerkens, PMP, PE
 Mohamed S. Hefny, MSc, PMP
 Krzysztof Hejduk, PhD, PMP
 Kel Henderson
 Robert Hierholtz
 Gary Higgs
 Hideyuki Hikida, PMP
 Merleen Cowie Hilley
 Bob Hillier, PMP
 David A. Hillson, PhD, PMP
 Lecia L. Hogan, MPM
 Mark Holdrege
 Carol Holliday, MA, PMP
 Felicia Hong, PMP, MBA
 George H. Hopman, PhD, PE
 Tim Hornett, PMP
 Gheorghe Hriscu, PMP, OCP
 Chih-Yang Hsia, PMP, MBA
 Jeff M Hughes, BA (Hons), PMP
 David T. Hulett, PhD
 Theresa L. Hunt, CSQE, CSTE
 Marta Hurst, CLSSBB
 Jean-Pierre Husereau, PMP,
 OPM3-CC
 Huma Hydari, MBA, PMP
 Zulfiqar Hussain, PE, PMP
 Midori Ito
 Suhail Iqbal, PE, PMP
 George Jackelen
 David S. Jacob, MS, PE
 Tony Jacob, PMP
 Dhanojkumar D. Jadhav
 Ashok Jain, PAHM, PMP

T.D. Jainendrakumar, PMP
 Nilesh D. Jaltare, PMP
 Ganesh Jambunathan, PMP
 Raj Kumar Jhajharia, PMP
 Marco Antonio Jimenez,
 PMP, MBA
 Merna M. Johnson, PMP
 Tony Johnson, PMP, PgMP
 Elden F. Jones II, PMP, MSPM
 Marylinda Jones, PMP, Six
 Sigma Greenbelt
 Michele J. Jones, PMP
 Nancy A. Joseph, PMP
 George Jucan, PMP
 Marijana Jurgec
 Lenin Babu Kamma, PMP
 Nils Kandelin, PhD, PMP
 Edwin J. Kapinus, PMP, PE
 Sanjay Kapoor
 Carl Karshagen, PMP
 Puja Kasariya, PMP
 Kenneth P. Katz, PMP
 Ramakrishna Kavirayani, PMP
 Kenichi Kawamata, PMP
 Genny Kelly
 Lance Kelson, CISSP, PMP
 Tom Kendrick, PMP
 Roger Kent, PMP
 Joseph W. Kestel, MSIS, PMP
 Rameshchandra B. Ketharaju
 Thomas C. Keuten, PMP,
 OPM3-CC
 Hamed Keyvanfar

Tausif Khawaja	Donald Likens	Cristinel Damian Martalogu
Jim Kinard, PMP	Diana Lilla, MA, PMP	John A. Marzullo, PMP
Konstantinos Kirytopoulos, PhD, PMP	Michelle Z. Lim-Watson	Rebecca P. Masucci
Joan Knutson, PMP	Robin Lindenmeier, PMP	Jamie Mata
Kimberly A. Kook, PMP, ITIL Foundations	Michael Linegar, PMP, MBA	Mohit Raj Mathur, PMP
Roman S. Kosarzycki, PMP	Kristin Linoski, PMP	Nael Mattar
Chetana S. Koulagi, PMP, CSQA	John D. Lissaman, BEng, PMP	Rahma Mbarki Eng, MSc, MBA
Mark Krahn, PhD, PMP	Arden Lockwood, MBA, PMP	Laura McDonough, PMP
Edie E. Kubomoto, PMP, CQM	Mary K. Lofsness	Colleen A. McGraw, PMP
Takahiko Kuki, PMP, JPE	Anand Lokhande, PMP	David McKenna, MSc, PMP
Milan Kumar, MCM, ITIL	Alberto Lopez, PMP	Yan Bello Méndez, PMP
Sasi Kumar, PMP	Enrique López-Mingueza, PMP	Louis J. Mercken, PMI Fellow, PMP
Karthikeyan Kumaraguru, MS, PMP	Margaret L. Love, PMP	Su Mei-Shih, PMP
Vijaya Kurada, MBA, PMP	Adrian Lovel-Hall	Kenneth Merten
Thomas M. Kurihara	Angela Cheng-Jui Lu, PhD, PMP	Predrag Fred Mikanovic, MBA, PMP
Lisa M. LaCourse, PMP	Chuanqing James Lu, PMP	Berne C. Miller, PMP, CPL
Jerry D. Lainhart, PMP	Yves M. Lucas, PMP	Walter Warren Miller III, PhD, PMP
S Lakshminarasimhan, MBA(Fin), PMP	Christina Luik	Sumith Alvet Miranda, PMP
Tim K.Y. Lam, PMP, MBA	Raymond Maczka	Purvi Sheth Mishra
Philippe Landucci, PMP	Shankar Mahadevan, PMP, CWA	Gregg Mohrmann
David J. Lanners, MBA, PMP	Robin Maher	Mark A. Monteleone, PMP, CBAP
David K. Larson	Catryana C. Malcolm, PMP	Gary Monti, PMP
Mary-Elizabeth Larson, PMP, CBAP	Konstantinos Maliakas, PMP	Carlos Morais, PMP
Richard G. Larson, PMP, CBAP	Rich Maltzman, PMP	John Morck
Marta M. Laszcz, PMP	Vasantha R. Manda, MS, PMP	Alberto Moreno, PMP
Charlene Lattier, PMP	Rick Mandarino, PMP, MBA	Paola Morgese, PE, PMP
Jim Lee Sr., PMP	Srinivas Mandgi, PMP, SAP HR	Kaoru Mori, PMP
Patty Leung	Carmelene Mangahis	Rogan Morrison, PMP
Juanita Jane Lightfoot	Ammar W. Mango, PgMP, PMP	Saradhi Motamarri, MTech, PMP
	Brian J. Mangravite	Bhagchand S. Motwani
	Joachim Manz, PhD, PMP	Stephen E. Mueller, PMP, EVP
	Lou Marks, PMP	
	Mark Marlin, PMP, PE	
	Robert A. Marshall, PhD, PMP	

Hazim Muhssin, PMP
 Rita Mulcahy, PMP
 Philips Tharakan Mulackal,
 PMP, CCE
 Gerald Mulenburg, DBA, PMP
 John L. Murphy, PE, PMP
 Pradeep Murti
 Carlo Muzzarelli
 Takamichi Nagano
 Prakash Nagaraju, PMP
 John T. Napier
 Kalyanraman Narayanswamy,
 PMP
 Faig Nasibov, PMP
 Muhammad Nasir
 John T. Nelson, BSc
 Mohammed Taher Netarwala,
 BE Mech, PMP
 Edgard Pedreira de Cerqueira
 Neto, PhD, PMP
 Michael Newell, PMP
 Thuthuy C. Nguyen, PMP
 Praveen K. Nidumolu, PMP
 Jeffrey S. Nielsen, PMP
 James S. Niziurski, PMP
 Michael C. Nollet, MBA, PMP
 Peter Ntiforo, PMP, BSc (Hons)
 Jeff Nuding, PMP
 Michael O'Brochta, MPM, PMP
 Deborah O'Bray, CIM (Hons)
 Edward A. O'Connor, PMP
 Charis Ogbonna
 Kazuhiko Okubo, PE, PMP
 James Ostad, PMP

Dmitry Ostroushko, PhD
 Beth Ouellette, MBA, PMP
 Priya Padmanabhan, PMP
 Nariman Panahian, PhD, PMP
 Mohan Pandey, MPharm,
 PGDM(IIMA)
 Tara Pangakis, PMP
 Leah Paras, PMP
 Balaji Parasuraman
 Kent D. Paris, PMP
 Hyung Ki Park, PMP
 William J. Parkes, PMP
 Frank R. Parth, MBA, PMP
 Jerry L. Partridge, PMP
 George Pasieka, aCPP, PMP
 Marcello Patrese, PMP, MPM
 Mridul Paul, PMP, MBA
 Peter B. Paulauskas, PMP
 Seenivasan Pavanasam,
 B Tech, PMP
 Almir dos Santos Pereira, PMP
 Nancy Perosio, PMP
 Robert E. Perrine, PMP
 Sitarama Chakravarthy
 Peruvel, PMP
 Bruce T. Petro, PMP
 Daniel Picard, PMP
 Crispin ("Kik") Piney, BSc, PMP
 George Pitagorsky, PMP
 Rama P. Pokala, PMP
 Morris A. Pondfield, MBA, MS
 Roberto Henrique Nogueira Pons
 Charles M. Poplos, EdD, PMP
 Steven S. Popovich

Steven R. Potter, PMP
 Janice Preston, PMP
 Carl L. Pritchard, PMP, EVP
 Carl W. Pro, PMP
 Nathan Pryce, EMTM, PMP
 Javier Pumar, PMP
 Jan F.M. Raes, PhD, PMP
 Regina Rahmilov
 V. Raja, PMP
 Aditya Rajguru, PMP
 S. Ramani, PgMP, PMP
 Ananthakrishnan
 Ramaswami, PMP
 Claudia Elisa Ramírez, PMP
 Dave Randell, PMP
 Gurdev S. Randhawa, PMP
 Shrish Rangaramanujam, PMP
 Banshidhar Rayaguru, PMP,
 M Tech
 Krupakara Reddy, PMP, PRINCE2
 Practitioner
 Caroline Robison, PMP
 Ana I. Rodríguez García, PMP
 Asbjørn Rolstadås, PhD, Ing
 Rafael Fernando Ronces
 Rosas, PMP
 Kenneth H. Rose, PMP
 Prakash Roshan, PMP
 David W. Ross, PMP, PgMP
 Neal L. Rowland, PMP
 Jaideep Roy
 Laurie M. Rudnitsky, PMP
 Lee Ryan
 Nani Sadowski-Alvarez, PMP

Osamu Sakamoto, PMP
 Brian Salk, MA Ed, PMP
 Gladstone Leslie Samuel
 Paul Sanghera, PhD, PMP
 Satheesh Santhangopalan, PMP
 Otavio Ritter Santos, PMP
 Rick B. Santos, MBA, PMP
 Vikas Sarin, ME(SS),MCA
 Ramanathan Sathianarayanan,
 PMP, CSQA
 Kyoichi Sato, PMP
 Curt Schlonies, PMP
 Eugene Schreiner
 John Schuyler, PE, PMP
 Salvatore J. Sciascia, PMP
 Anna Self
 Benjamin R. Sellers, PMP, CPCM
 Kathakali Seth
 Mark B. Shadowens, PMP
 Paul E. Shaltry, PMP
 Archana Sharma, MS, PMP
 Dhilan N. Shah, CPA, PMP
 Manar Shami, PhD, PMP
 Shervin Shariatpanahi
 Mojtabanejad
 Pawan Sharma
 Rachna Sharma
 John Sheers, PMP
 Jinmei Shen, PMP
 Nitin Shende
 Eng. S.M. Saliha Sheriff,
 MBA, PMP
 Kazuo Shimizu, PMP
 Toshihiro Shoji, PMP

Hilary Shreter, MBA, PMP
 Evandro L.P. Silva
 João Carlos A. Silva Neto,
 Msc, PMP
 Michael D. Simants
 Michael Simmering, PE,
 OPM3-CC
 Nicklaus B. Sims, PMP
 Manas Singh
 Siddharth Singh
 John Singley, PhD, PMP
 Marzena Zych- Skrzypkowska
 Kathy J. Slater, PMP
 Martin J. Smit, PMP
 Carolyn E. Smith, PMP
 Bruce F. Snow
 Juliette A. Soczka
 Jorge Garcia Solano, PMP
 John P. Soltesz, PE, PMP
 Nguyen Hoanh Son
 Brijesh Sonawane, PMP
 Mauro Sotille, PMP
 Patricia Spadea, PMP
 Bernd Spiehl
 Carolina Gabriela Spindola,
 SSB, PMP
 Clifford W. Sprague, PMP
 Rob Spurgeon
 Varadarajan Sriram
 Pranay Srivastava, PMP, CISA
 Jolene R. Staruch, PMP
 Joyce Statz, PhD, PMP
 Doug Stephon
 Samuel N. Stevens III, PhD

Delores Stimpson, PMP
 Roberta Storer
 Dr Kenneth D Strang, PhD, PMP
 Geree V. Streun, CSQE, PMP
 Michael E. (Mike) Strom, PMP
 Juergen Sturany, PMP
 Chinta V.N. Subrahmanyam,
 PMP
 Brian T. Sullivan, PMP
 Raghavan Sundararajan, PMP
 Yasuji Suzuki, PMP
 Rashid M. Syed, MBA, PMP
 Michal Szymaczek, PMP
 Amin Tabatabayi, BEng, MBA
 Shoji Tajima, PMP
 Masanori Takahashi, PMP, MA
 Paraminder Talwar, PMP
 Randy Tangco, PMP, CSM
 Nilesh Adrian Pieris Tavarayan,
 AMBCS, MACS (Prov)
 John Terdik, PMP, DCB
 Gangesh Thakur, CPIM, CSCP
 Jaimini Thakore
 Pham Minh Thang
 Claire-Jodane Thermidor
 William M. Thom, PMP
 Darin Thomas, PMP
 William J. Thompson, PE, PMP
 Rocky Thurston, PMP
 Linus G. Tibayan, FLMI, PMP
 Surendra Tipparaju, ME
 Lulu V. Tobin, PMP
 Victoria Todas-Lozada, PMP
 Mark Tolbert

Nagla Toma, MA
 Carolyn A. Toomer, PMP
 Terry D. Tosh, PMP
 Lee Towe, PMP, MBA
 Biagio Tramontana, Ing, PMP
 R. Trant, BA, C Mar Eng
 Ricardo Triana, PMP
 Daniel J. Troxell, MBA, PMP
 Shi-Ja Tseng
 William Stephen Turner
 Vidyasagar Uddagiri, PMP
 Nnanna Charles Ukaegbu,
 PE, PMP
 Krishnakant T. Upadhyaya, PMP
 Eric Uyttewaal,
 MS Business, PMP
 Ali Vahedi Diz, MSc, PMP
 Jorge Valdés Garcíatorres,
 PMP, ITIL
 Dennis K. Van Gemert, MS, PMP
 Paula Ximena Varas, PMP
 Ricardo Viana Vargas, MSc, PMP
 Jouko Vaskimo, PMP
 Thierry Verlynde, PMP
 Malay Verma, PMP, PGCBM
 Vijay K. Verma, PMP, MBA

Aloysio Vianna Jr.
 David Violette, MPM, PMP
 Pepijn Visser
 Cornelis (Kees) Vonk
 Paul E. Waits, Jr., PMP, CPM
 Mike Wakshull, PMP, MSc
 Ronald P. C. Waller,
 PMI Fellow, PMP
 Barbara Walsh, CAPM
 Thomas M. Walsh, PMP
 Steve J. Walter, PhD, CSEP, PMP
 Xiaojin Wang, PhD, PMP
 Lou Ware, PMP
 William W. Wassel, PE, PMP
 Ian J. Watson, PMP
 Michael D. Watson, PMP
 Patrick Weaver, PMP, FAICD
 John A. Weber, PMP
 Kevin R. Wegryn, PMP, CPM
 Linda Westfall, CSQE, PE
 John White
 Mark Wilfer, PMP
 Donald Wilkinson, PMP
 Nancy Wilkinson, MBA, PMP
 Dale K. Williams, PMP, CSM
 Terry Williams, PhD, PMP

John Wilson, PhD, PMP
 Rebecca A. Winston, JD
 Michael Witzorky, PMP
 Audrey R. Wojcik
 Nan Wolfslayer, AStd
 Rick Woods, SSBB, PMP
 Mark A. Wright, PMP
 Vicki Wrona, PMP
 Andrew Lam Tug Wye, PMP,
 CITPM (Associate)
 Kazuo Yamamoto, PMP
 Shahrzad Yazdani, PMP, LSS GB
 Clement C.L. Yeung, PMP
 Masakazu Yonezaki
 Tan EE Yuen Yvonne
 Azam M. Zaqzouq, MCT, PMP
 Omran M. Zbeida
 Xuyan Zhang
 Rob Zilay, MBA, PMP
 K. Kimi Hirotsu Ziemski, PMP
 Paul W. Zilmer, PMP
 William A. Zimmer, PMP
 Heinz Zimmermann, MSc, PMP
 John Zlockie, MBA, PMP

X2.10 The *PMBOK® Guide*—Third Edition

Dennis Bolles, PMP, Project Manager
 Darrel G. Hubbard, PE, Deputy Project Manager
 J. David Blaine, PMP (Quality Control Coordinator)
 Theodore R. Boccuzzi, PMP (Document Research Team Leader)
 Elden Jones, PMP (Configuration Management Coordinator)
 Dorothy Kangas, PMP (Product Overview Team Leader)
 Carol Steuer, PMP (Framework Team Leader)
 Geree Streun, PMP (Process Groups Team Leader)
 Lee Towe, PMP (Special Appointment)

X2.10.1 Other Contributors:

Abdallah Abi-Aad, PMP, PEng
 Muhamed Abdomerovic, PMP
 Adrian Abramovici, PMP
 Fred Abrams, PMP, CPL
 Yassir Afaneh
 Hussain Ali Al-Ansari,
 Eur Ing, CEng
 Mohammed Abdulla Al-Kuwari,
 Eur Ing, CEng
 Jamie K. Allen, PMP
 Mark Allyn, PMP
 Sumner Alpert, PMP, CMC
 Frank Anbari
 Scott C. Anderson, PMP
 Lionel Andrew, MBA, ISP
 Russell Archibald, PMP
 Prabu V. Ayyagari, PhD, PMP

William W. Bahnmaier, PMP
 Alfred Baker
 Ernest Baker, PMP
 Pamela M. Baker, PMP
 W. Clifton Baldwin, PMP
 B. D. Barnes
 Kevin E. Bast, PMP
 Jefferson Bastreggi
 Mohammed Safi Batley, MIM
 Julia M. Bednar, PMP
 James S. Bennett, PMP
 Cynthia A. Berg, PMP
 Sally Bernstein, PMP
 Mamoun A. Besaiso, CE
 Ionut C. Bibac
 Howland Blackiston
 J. David Blaine, PMP, CSQE

Ray Blake, PMP
 Nigel Blampied, PE, PMP
 Dennis Bolles, PMP
 Stephen Bonk
 Barbara Borgmann, PMP
 Charles W. Bosler, Jr.
 Gregory M. Bowen, CSDP
 Rollin O. Bowen, Jr.
 Carolyn Boyles, MBA, PMP
 David Bradford, PMP
 James (Jim) P. Branden,
 MBA, PMP
 Wayne R. Brantley, PMP, MS Ed
 Gary D. Brawley, PEng., PMP
 Alex S. Brown, PMP
 Timothy S. Brown
 Stephen C. Burgan, PMP

Anne Cagle, PMP	Alfredo del Cano, PE, PhD	Gary W. Fortune, PMP
Dean J. Calabrese, PMP	Connie Delisle	John M. Foster, PMP, MBA
Neil R. Caldwell	Andrea Giulio Demaria, PMP	Scott D. Freauf, PMP
Giuseppe A. Caruso, PMP	John M. Dery, PMP	Denis Freeland
Edgard P. Cerqueira Neto, PhD, PMP	Barbara De Vries, PMP	Ichiro Fujita, PMP
Bruce Chadbourne	Ravi Kumar Dikshit, PMP	John S. Galliano
Bill Chadick, PMP	Jerry Dimos, PMP	Donald G. Gardner, PMP
Clare Chan	James A. Doanes	Stanisław Gasik
Porfirio Chen Chang, MBA, PMP	Capt. Nick Doralp, PMP	Jackelen George
Ho Lee Cheong, PhD, MIMechE	John Downing	Jose A. George, B Tech, PGDM
Gene Chiappetta, PMP	Magnus Karl Drengwitz, PMP	Dan Georgopoulos
Tomio Chiba, PMP	Daniel Dudek	Paul H. Gil, MCP, PMP
Mark T. Chism, PMP	Peter Duignan, PMP	Greg Githens, PMP
Aaron Coffman, PMP, CQM	Lloyd R. Duke, Jr., PMP	Earl Glenwright, PE, VEA
Kim D. Colenso, PMP, CSQE	Suhas Dutta, PMP	Leo A. Giulianetti, PMP
Edmund H. Conrow, PhD, PMP	Judith Edwards, PhD, PMP	Christopher A. Goetz, PMP
Helen S. Cooke, PMP	Bradford R. Eichhorn, PMP	Donna Golden
Michael Corish	Gary S. Elliott, MS, MD	Dan Goldfischer
John E. Cormier, PMP	Robert L. Emerson, PMP	Neil P. Goldman, PMP
John Cornman, PMP, MBA	Alison Evanish	Margarida Goncalves, PhD
Sergio R. Coronado	Gregory William Fabian, PMP	John C. Goodpasture, PMP
Andy Crowe, PMP	Steven L. Fahrenkrog, PMP	Dana J. Goulston, PMP
Robert L. Cutler, PMP	Morten Fangel, PhD	Neal S. Gray, PMP
Darren Dalcher, PhD, MAPM	Keith Farndale, PEng, PMP	Steve Grey, PhD, PMP
Mario Damiani, PMP	Martin Christopher Fears, PMP	Robert J. Gries, PE, PMP
Shari M. Daniel, PMP	Eve Featherman	Mike Griffiths, PMP
Arindam Das	AnnaMaria Felici	Patrick D. Guest, PMP
Pranab Das, PMP	Flynn M. Fernandes, MSPM, PMP	Jinendra Gunathilaka, PE
Aloysio da Silva	John C. “Buck” Field, MBA, PMP	Navneet Gupta, PMP
Allan E. Dean	Linda Fitzgerald	David R. Haas, PMP, FLMI
Robert de Jong, PMP	Quentin W. Fleming	Aaron S. Hall, PMP
Juan De La Cruz	David Foley, MBA	Robert W. Harding, RA
M. Pilar De La Cruz	Kirby Fortenberry, PMP	Delbert K. Hardy, PMP
		Patti Harter

J. Ray Harwood, PMP
 Ali Hassan, PMP
 Ralph Hernandez
 Rick Hiatt
 Pat Hillcoat, PMP
 Bob Hillier, PMP
 David Hillson, PhD, PMP
 Guy N. Hindley, MAPM, MILT
 Danny N. Hinton, PMP
 Bobby Tsan Fai Ho, PMP, CISM
 J. Brian Hobbs, PhD, PMP
 Piet Holbrouck, MSc
 Carol Holliday, PMP
 Gopi V. Hombal
 Martin Hopkinson, BSc, APMP
 Keith D. Hornbacher, MBA
 Darrel G. Hubbard, PE
 Kenneth Alan Hudacsko, PMP
 David T. Hulett, PhD, PMP
 Clinton in't Veld
 Adesh Jain, PMP, MPD
 Don R. James, PMP
 Grant Jefferson
 Noel C. Jensen, PMP
 Wei Jing
 Bruce Johnson, PMP
 Elden Jones, MSPM, PMP
 Granville H. Jones, Sr.,
 MBA, PMP
 Kevin B. Jones, BMath, PMP
 Howard J. Kalinsky, PMP, MPM
 Constance Katsanis
 Roger Kent
 Tom Kerr, PMP
 Ajmal Afzal Khan
 Asadullah Khan, PMP
 Lucy Kim, PE, PMP
 Mihail Kitanovski
 Jennifer Eileen Kraft
 Takahiko Kuki, PE, PMP
 Polisetty V.S. Kumar,
 M Tech, PMP
 Avis Kunz
 Thomas Kurihara
 Antonio Carlos Laranjo da Silva
 John S. Layman, PMP
 Lawrence (Larry) P. Leach, PMP
 Craig Letavec
 Ben Linders
 Erik D. Lindquist, PE, PMP
 Mary K. Lofsness
 Elizabeth Ann Long, PMP
 Raul S. Lopez, PE, PMP
 Enrique Lopez-Mingueza, PMP
 Pier Paolo Lo Valvo, PMP
 Karen Griffin MacNeil, PMP
 Sajith K. Madapatu, PMP
 Vijaya Kumar Mani, PMP
 Mark Marlin, PMP
 Enrique Martinez
 Victor J. Matheron, PMP
 Stephen S. Mattingly
 Christopher J. Maughan,
 CEng, PMP
 Giuseppe Mauri
 Yves Mboda, PMP
 David L. McPeters, PMP
 Ed Mechler, PMP
 Godfrey I. Meertens, PMP
 Richard Meertens, MBA, PMP
 Yan Bello Mendez, PMP
 Gordon R. Miller, PMP, CCP
 Liu Min
 Santosh Kumar Mishra,
 PMP, CSQA
 Andrew H. Moore, MBA, PMP
 Colin Morris, PE, PMP
 Saradhi Motamarri, M Tech, PMP
 Mhlabaniseni Moses Mitmunye
 Rita Mulcahy, PMP
 Charles L. Munch, PMP
 K.S. Keshava Murthy
 Jo Musto, PMP
 AnathaKrishnan
 S. Nallepally, PMP
 NB Narayanan
 Vijayalakshimi Neela, MCA, PMP
 Beatrice Nelson, PMP
 Brian D. Nelson, PMP
 Jeffrey S. Nielsen, PMP
 Isabella Nizza, PMP
 Jim O'Brien, PMP
 Kazuhiko Okubo, PE, PMP
 David M. Olson, MBA (ITM)
 Peter Ostrom, PhD, PMP
 Jeffery L. Ottesen, PE
 Michael T. Ozeranic
 Laura Dorival Paglione
 Ravindranath Palahalli

Glen R. Palmer	Cheryl N. Rogers, PMP	Larry Sieck
Jon Palmquist	Asbjorn Rolstadas, PhD	Melvin Silverman, PhD, PE
Nick Palumbo, PMP	Hans (Ron) Ronhovde, PMP	Fernando Demattio de O. Simoes, PMP
David Parker	Scott A. Rose, PMP	Richard L. Sinatra, PhD, PMP
Jerry L. Partridge, PMP	Ed Rosenstein, PMP	Raghavendra Singh
George Pasieka, PMP	David W. Ross, PMP	John E. Singley, PhD, PMP
Eric Patel	Samuel S. Roth, PMP	Edward Smith
Anil Peer, PEng, PMP	Joseph A. Roushdi	Patricia Smith
Francisco Perez-Polo	Gurdev Roy, PMP	Cynthia Snyder, MBA, PMP
Paul W. Phister, Jr., PhD, PE	Paul S. Royer, PMP	Antonio Soares
Crispin (Kik) Piney, BSc, PMP	James J. Rutushni, PMP	Paul Solomon, PMP
Natasha Pollard	Robbi Ryan	Richard Spector, PMP
Sreenivasa Rao Potti, MCA, PMP	Frank Ryle, PMP	Allison St. Jean
Manohar Powar, PMP	Anjali Sabharwal, PMP	Michael Stefanovic, PEng, PMP
Ravindranath P S	Srinivasa R. Sajja, PMP	Geree Streun, PMP
Patrick J. Quairolì	Brian Salk, MA Ed, PMP	Juergen Sturany
Ge Qun	Nashaat A. Salman, PMP	Donglin Su
Vara Prasad Raju Kunada	Kyoichi Sato	Sambasivam S., PMP, CSQA
Gurdev Randhawa	Markus Scheibel, PMP, Dipl-Ing	George Sukumar, MSChe, OE
Prem Ranganath, PMP	Suzanne Lee Schmidt, PMP	Karen Z. Sullivan, PMP
Raju Rao, PMP	John Schmitt, PMP	Karen Tate, MBA, PMP
Ulka Rathi	Amy Schneider, PMP	David E. Taylor, PMP
Carol Rauh, PhD, PMP	Michael J. Schollmeyer, PMP	James E. Teer, Jr.
Tony Raymond	Randa Schollmeyer, PMP	Sai K. Thallam, MBA, PMP
Vijay Sai Reddy, PMP, CSQA	Richard E. Schwartz	John A. Thoren, Jr., PhD, PMP
J. Logan C. Rice	Andrea R. Scott	Surendra Tipparaju, ME
Steven Ricks, PMP	Benjamin R. Sellers, PMP, CPCCM	Massimo Torre, PhD, PMP
Steven F. Ritter, PMP	Tufan Sevim, PMP	Luis Eduardo Torres Calzada, MBA, PMP
Thad B. Ring, PMP	Sanjay Shah, PMP	Rogério Carlos Traballi
Dee Rizor	Mundaje S. Shetty, PMP	Lee Towe, MBA, PMP
Susan Rizzi	Kazuo Shimizu, PMP	Rufis A. Turpin, CQA, CSQE
Michael C. Roach	Rali Shital	
Alexandre G. Rodrigues, PhD	Ganga Siebertz	

Marion J. Tyler, PMP
 M. Raj Ullagaraj, PhD
 Bobbye Underwood, PMP
 Eric Uyttewaal, PMP
 Dalton L. Valeriano-Alves, ME
 JR Vanden Eynde, PMP
 Gary Van Eck
 Judy Van Meter
 J.R. Vanden Eynde, PMP
 Gerrit van Otterdijk, BSc
 Thomas G. Van Scoyoc, PMP
 Paula X. Varas, PMP
 Ricardo Vargas
 Ricardo Viana Vargas, MSc, PMP
 Aloysio Vianna, Jr.
 Mark M. Vertin, PE, PMP

Craig Veteto, PMP, CPIM
 Roberto Viale, PMP
 Eduardo Newton Vieira, PMP
 Dave Violette, MPM, PMP
 Desmond Joseph Vize, PMP
 Cornelius (Kees) Vonk, PMP
 J. Wendell Wagner, PMP
 Barbara Walsh
 Thomas M. Walsh, PMP
 William W. Wassel, PE, PMP
 Patrick Weaver, PMP, FAICD
 Kevin R. Wegryn, PMP, CPM
 Timothy E. Welker, PMP
 Linda Westfall, PE, CSQE
 Gwen Whitman, PMP
 Tammo T. Wilkens, PE, PMP

Alan K. Williams, Sr., PMP
 Charles M. Williamson,
 MBA, PMP
 Stephen D. Wise
 Allan Wong
 Robert Wood
 Kristin L. Wright
 Thomas Wuttke, PMP, CPM
 Uma S. Yalamanchili, PMP
 Clement C.L. Yeung, PMP
 Angela F. Young, PMP
 John Zachar, BSc, APMP
 Kathy Zandbergen
 Cristine Zerpa
 Paul Zilmer
 Eire E. Zimmermann, PMP

X2.11 The *PMBOK® Guide*—2000 Edition

Cynthia A. Berg, PMP
 Judith A. Doll, PMP
 Daniel Dudek, PMP
 Quentin Fleming
 Greg Githens, PMP
 Earl Glenwright
 David T. Hulett, PhD
 Gregory J. Skulmoski

X2.11.1 Other Contributors:

Muhamed Abdomerovic, PMP,
D. Eng.

John R. Adams

Yassir Afaneh

Frank Allen, PMP

Jon D. Allen, PMP

MaryGrace Allenchey, PMP

Robert A. Andrejko, PMP

Ichizo Aoki

Paul C. Aspinwall

Ronald Auffrédou, PMP

Edward Averill, PMP

Frederick L. Ayer, PMP

William W. Bahnmaier, PMP

A. C. “Fred” Baker, PMP

Carole J. Bass, PMP

George Belev

Berndt Bellman

Sally Bernstein, PMP

Nigel Blampied, PE, PMP

John Blatta

Patrick Brown, PMP

Alfredo del Caño

Chris Cartwright, PMP

Bruce C. Chadbourne, PMP

Michael T. Clark, PMP

Raymond C. Clark, PE

Elizabeth Clarke

David Coates, PMP

Kim Colenso, PMP

Edmund H. Conrow, PMP

Kenneth G. Cooper

Sergio Coronado Arrechedera

John Cornman, PMP

Richard F. Cowan, PMP

Kevin Daly, PMP

Mario Damiani, PMP

Thomas Diethelm, PMP

David M. Drevinsky, PMP

William R. Duncan

Frank D. Einhorn, PMP

Steven L. Fahrenkrog

Edward Fern, PMP

Lisa Fisher

Christian Frankenberg, PMP

Scott D. Freauf, PMP

Jean-Luc Frere, PMP

Ichiro Fujita, PMP

Chikako Futamura, PMP

Serge Garon, PEng, PMP

Brian L. Garrison, PMP

Lewis M. Gedansky

Linda V. Gillman

Eric Glover

Eva T. Goldman

Peter Bryan Goldsbury

Michael Goodman, PMP

Jean Gouix, PMP

Paul Grace

Alexander Grassi Sr., PMP

Roger Graves

Franz X. Hake

Peter Heffron

Chris Herbert, PMP

Dr. David Hillson, PMP, FAPM

J. Brian Hobbs, PMP

Marion Diane Holbrook

Robin Hornby

David Hotchkiss, PMP

Bill Hubbard

Charles L. Hunt

Thomas P. Hurley, PMP

George Jackelen

Angyan P. Jagathnarayanan

Sandy Jenkins

Elden F. Jones II, PMP, CMII

Sada Joshi, PMP

Lewis Kana, PMP

Subramaniam Kandaswamy,
PhD, PMP

Ronald L. Kempf, PMP

Robert Dohn Kissinger,
PhD, PMP

Kurt V. Kloecker

Toni D. Knott

Jan Kristrom

Blase Kwok, PMP

Sam Lane

Lawrence P. Leach

Philip A. Lindeman

Gábor Lipi
Lyle W. Lockwood, PMP
J. W. Lowthian, PMP
Arif Mahmood, PMP
James Martin (on behalf
of INCOSE)
Stephen S. Mattingly
Glen Maxfield
Peter McCarthy
Rob McCormack, PMP
John McHugh
Krik D. McManus
Dewey L. Messer
David Michaud
Mary F. Miekoski, PMP
Oscar A. Mignone
Gordon R. Miller, PMP
Roy E. Morgan, PMP
Jim Morris, PMP
Bert Mosterd, PMP
William A. Moylan, PMP
John D. Nelson, PMP
Wolfgang Obermeier
Cathy Oest, PMP
Masato Ohori, PMP
Kazuhiko Okubo, PE, PMP
Edward Oliver
Michelle Triggs Owen
Mark S. Parker
Shirley B. Parker
Matthew H. Parry

Jerry Partridge, PMP
Francisco Perez-Polo, PMP
James M. Phillips, PMP
Crispin (Kik) Piney, PMP
George Pitagorsky, PMP
David L. Prater, PMP
Janice Preston
Bradford S. Price, PMP
Samuel L. Raisch, PMP
Naga Rajan
G. Ramachandran, PMP
Stephen Reed
Bill Righter, PMP
Bernice L. Rocque, PMP
Wolfgang Theodore Roesch
Fernando Romero Peñailillo
Jon Rude
Linda Rust, PMP
Fabian Sagristani, PMP
James N. Salapatas, PMP
Seymour Samuels
Bradford N. Scales
H. Peter Schiller
John R. Schuyler, PMP
Maria Scott, PMP
Shoukat Sheikh, MBA, PMP
Larry Sieck
Kazuo Shimizu, PMP
David Shuster
Melvin Silverman, PhD, PE
Loren J. Simer Jr.

Keith Skilling, PE, PMP
Ed Smith
Kenneth F. Smith, PMP
Barry Smythe, PMP
Paul J. Solomon
Joe Soto Sr., PMP
Christopher Wesley Sours, PMP
Charlene Spoede, PMP
Joyce Statz, PMP
Emmett Stine, PMP
Alan Stretton
Thangavel Subbu
Jim Szpakowski
Ahmet N. Taspinar, PMP
John A. Thoren Jr., PMP
Ilesha D. Turner-Brown
Alan D. Uren, PMP
Juan Luis Valero, PMP
S. Rao Vallabhaneni
William Simon Vaughan
Robinson
Ana Isabel Vazquez Urbina
Ricardo Viana Vargas, PMP
Mike Wakshull
Stephen E. Wall, PMP
William W. Wassel, PMP
R. Max Wideman
Tammo T. Wilkens, PE, PMP
Robert Williford, PMP
Robert Youker

X2.12 The *PMBOK® Guide*—1996 Edition

William R. Duncan
Frederick Ayer
Cynthia Berg
Mark Burgess
Helen Cooke
Judy Doll
Drew Fetters
Brian Fletcher
Earl Glenwright
Eric Jenett
Deborah O’Bray
Diane Quinn
Anthony Rizzotto
Alan Stretton
Douglas E. Tryloff

X2.12.1 Other Contributors:

John Adams
Edward L. Averill
C. “Fred” Baker
F. J. “Bud” Baker
Tom Belanger
John A. Bing
Brian Bock
Paul Bosakowski
Keely Brunner
Dorothy J. Burton

Jeannette M. Cabanis
Louis J. Cabano
Kim Colenso
Samuel K. Collier
Karen Condos-Alfonsi
E. J. Coyle
Darlene Crane
David Curling
Russ Darnall
Misty N. Dillard

Maureen Dougherty
John J. Downing
Daniel D. Dudek
Lawrence East
Quentin W. Fleming
Rick Fletcher
Linda V. Gillman
Greg Githens
Douglas Gordon
Leo Giulianeti

Martha D. Hammonds	Rick Michaels	Steven F. Ritter
Abdulrazak Hajibrahim	Raymond Miller	William S. Ruggles
G. Alan Hellawell	Alan Minson	Ralph B. Sackman
Bobby R. Hensley	Colin Morris	Agnes Salvo
Jonathan Hicks	R. Bruce Morris	Alice Sapienza
Paul Hinkley	Danell Moses	W. Stephen Sawle
Wayne L. Hinthorn	David J. Mueller	Darryl M. Selleck
Mark E. Hodson	Gary Nelson	Melvin Silverman
David T. Hulett	John M. Nevison	Roy Smith
Edward Ionata	John P. Nolan	Leonard Stolba
Lew Ireland	Louise C. Novakowski	Craig T. Stone
Elvin Isgrig	James O'Brien	Hiroshi Tanaka
Murray Janzen	JoAnn C. Osmer	Ahmet Taspinar
Frank Jenes	Jon V. Palmquist	Robert Templeton
Sandy Jenkins	Mark S. Parker	Dick Thiel
Walter Karpowski	Shirley B. Parker	Saul Thomashow
William F. Kerrigan	Matthew Parry	J. Tidhar
Harold Kerzner	John G. Phippen	Janet Toepfer
Robert L. Kimmons	Hans E. Picard	Michelle Triggs
Richard King	Melissa Pendergast	Vijay K. Verma
J. D. "Kaay" Koch	James S. Pennypacker	Alex Walton
Lauri Koskela	Serge Y. Pottie	Jack Way
Richard E. Little	PMI Houston Chapter	Francis M. Webster Jr.
Lyle W. Lockwood	PMI Manitoba Chapter	R. Max Wideman
Lawrence Mack	PMI New Zealand Chapter	Rebecca Winston
Christopher Madigan	Charles J. Pospisil	Hugh M. Woodward
Michael L. McCauley	Janice Y. Preston	Lisa Woodring
Hugh McLaughlin	Mark T. Price	Robert Youker
Frank McNeely	Christopher Quaife	Shakir H. Zuberi
Pierre Menard	Peter E. Quinn	Dirk Zwart
Dewey L. Messer	Hadley Reynolds	

APPENDIX X3

INTERPERSONAL SKILLS

Project managers accomplish work through the project team and other stakeholders. Effective project managers acquire a balance of technical, interpersonal, and conceptual skills that help them analyze situations and interact appropriately. This appendix describes important interpersonal skills, such as:

- Leadership
- Team building
- Motivation
- Communication
- Influencing
- Decision making
- Political and cultural awareness
- Negotiation
- Trust building
- Conflict management
- Coaching

While there are additional interpersonal skills that project managers use, the appropriate use of these skills assists the project manager in effectively managing the project.

X3.1 Leadership

Leadership involves focusing the efforts of a group of people toward a common goal and enabling them to work as a team. In general terms, leadership is the ability to get things done through others. Respect and trust, rather than fear and submission, are the key elements of effective leadership. Although important throughout all project phases, effective leadership is critical during the beginning phases of a project when the emphasis is on communicating the vision and motivating and inspiring project participants to achieve high performance.

Throughout the project, the project team leaders are responsible for establishing and maintaining the vision, strategy, and communications; fostering trust and team building; influencing, mentoring, and monitoring; and evaluating the performance of the team and the project.

X3.2 Team Building

Team building is the process of helping a group of individuals, bound by a common purpose, to work with each other, the leader, external stakeholders, and the organization. The result of good leadership and good team building is teamwork.

Team-building activities consist of tasks (establish goals, define, and negotiate roles, responsibilities, and procedures) and processes (interpersonal behavior with emphasis on communication, conflict management, motivation, and leadership). Developing a team environment involves handling project team problems and discussing these as team issues without placing blame on individuals. Team building can be further enhanced by obtaining top management support; encouraging team member commitment; introducing appropriate rewards, recognition, and ethics; creating a team identity; managing conflicts effectively; promoting trust and open communication among team members; and providing leadership.

While team building is essential during the front end of a project, it is an ongoing process. Changes in a project environment are inevitable. To manage these changes effectively, a continued or renewed team-building effort is required. Outcomes of team building include mutual trust, high quality of information exchange, better decision making, and effective project management.

X3.3 Motivation

Project teams are comprised of team members with diverse backgrounds, expectations, and individual objectives. The overall success of the project depends upon the project team's commitment, which is directly related to their level of motivation.

Motivating in a project environment involves creating an environment to meet project objectives while providing maximum satisfaction related to what people value most. These values may include job satisfaction, challenging work, a sense of accomplishment, achievement and growth, sufficient financial compensation, and other rewards and recognition the individual considers necessary and important.

X3.4 Communication

Communication has been identified as one of the single biggest reasons for project success or failure. Effective communication within the project team and between the project manager, team members, and all external stakeholders is essential. Openness in communication is a gateway to teamwork and high performance. It improves relationships among project team members and creates mutual trust.

To communicate effectively, the project manager should be aware of the communication styles of other parties, cultural nuances/norms, relationships, personalities, and the overall context of the situation. Awareness of these factors leads to mutual understanding and thus to effective communication. Project managers should identify various communication channels, understand what information they need to provide, what information they need to receive, and which interpersonal skills will help them communicate effectively with various project stakeholders. Carrying out team-building activities to determine team member communications styles (e.g., directive, collaborative, logical, explorer, etc.), allows managers to plan their communications with appropriate sensitivity to relationships and cultural differences.

Listening is an important part of communication. Listening techniques, both active and passive give the user insight to problem areas, negotiation and conflict management strategies, decision making, and problem resolution.

X3.5 Influencing

Influencing is a strategy of sharing power and relying on interpersonal skills to get others to cooperate towards common goals. Using the following guidelines can influence team members:

- Lead by example, and follow through with commitments.
- Clarify how a decision will be made.
- Use a flexible interpersonal style and adjust the style to the audience.

Apply your power skillfully and cautiously. Think of long-term collaboration.

X3.6 Decision Making

There are four basic decision styles normally used by project managers: command, consultation, consensus, and coin flip (random). There are four major factors that affect the decision style: time constraints, trust, quality, and acceptance. Project managers may make decisions individually, or they may involve the project team in the decision-making process.

Project managers and project teams use a decision-making model or process such as the six-phase model shown below.

- **Problem Definition.** Fully explore, clarify, and define the problem.
- **Problem Solution Generation.** Prolong the new idea-generating process by brainstorming multiple solutions and discouraging premature decisions.
- **Ideas to Action.** Define evaluation criteria, rate pros and cons of alternatives, select best solution.
- **Solution Action Planning.** Involve key participants to gain acceptance and commitment to making the solution work.
- **Solution Evaluation Planning.** Perform post-implementation analysis, evaluation, and lessons learned.
- **Evaluation of the Outcome and Process.** Evaluate how well the problem was solved or project goals were achieved (extension of previous phase).

X3.7 Political and Cultural Awareness

Organizational politics are inevitable in project environments due to the diversity in norms, backgrounds, and expectations of the people involved with a project. The skillful use of politics and power helps the project manager to be successful. Conversely, ignoring or avoiding project politics and inappropriate use of power can lead to difficulty in managing projects.

Today project managers operate in a global environment, and many projects exist in an environment of cultural diversity. By understanding and capitalizing on cultural differences, the project management team is more likely to create an environment of mutual trust and a win-win atmosphere. Cultural differences can be both individual and corporate in nature and may involve both internal and external stakeholders. An effective way to manage this cultural diversity is through getting to know the various team members and the use of good communication planning as part of the overall project plan.

Culture at a behavioral level includes those behaviors and expectations that occur independently of geography, ethnic heritage, or common and disparate languages. Culture can impact the speed of working, the decision-making process, and the impulse to act without appropriate planning. This may lead to conflict and stress in some organizations, thereby affecting the performance of project managers and project teams.

X3.8 Negotiation

Negotiation is a strategy of conferring with parties of shared or opposed interests with a view toward compromise or reaching an agreement. Negotiation is an integral part of project management and done well, increases the probability of project success.

The following skills and behaviors are useful in negotiating successfully:

- Analyze the situation.
- Differentiate between wants and needs, both theirs and yours.
- Focus on interests and issues rather than on positions.
- Ask high and offer low, but be realistic.
- When you make a concession, act as if you are yielding something of value, don't just give in.
- Both parties should feel as if they have won. This win-win negotiating style is preferred but not always achievable. If possible, don't let the other party leave feeling as though he or she has been taken advantage of.
- Listen attentively and communicate articulately.

X3.9 Trust Building

The ability to build trust across the project team and other key stakeholders is a critical component in effective team leadership. Trust is associated with cooperation, information sharing, and effective problem resolution. Without trust it is difficult to establish the positive relationships necessary between the various stakeholders engaged in the project. When trust is compromised, relationships deteriorate, people disengage, and collaboration becomes more difficult, if not impossible.

Some actions project managers can take to help build trust:

- Engage in open and direct communications to resolve problems.
- Keep all stakeholders informed, especially when fulfilling commitments is at risk.
- Spend time directly engaged with the team asking nonassumptive questions to gain a better understanding of the situations affecting the team.
- Be direct and explicit about what you need or expect.
- Do not withhold information out of a fear of being wrong but be willing to share information even if you may be wrong.
- Be receptive to innovation and address any issues or concerns in a forthright manner.
- Look beyond your own interests.
- Demonstrate a true concern for others and avoid engaging in pursuits that could be viewed as being detrimental to the interest of others.

X3.10 Conflict Management

Conflict is inevitable in a project environment. Incongruent requirements, competition for resources, breakdowns in communications, and many other factors could become sources of conflict. Within a project's environment, conflict may yield dysfunctional outcomes. However, if actively managed, conflicts can actually help the team arrive at a better solution. The project manager must be able to identify the causes for conflict and then actively manage the conflict thus minimizing potential negative impacts. The project team is then able to deliver better solutions and increase the probability of project success.

Project managers must develop the skills and experience necessary to effectively adapt their personal conflict management style to the situation. Managing conflict in a project environment involves building the trust necessary for all involved parties to be open and honest, and to engage in seeking a positive resolution to the situation creating the conflict. Project managers strive to establish a collaborative approach among the team members involved in order to fully resolve the problems. In situations where a collaborative approach is not possible, the project manager must then revert to other active management styles for handling the conflict; e.g., assertiveness, accommodation, avoidance, or compromise.

Managing conflict is one of the biggest challenges a project manager faces. It draws upon all of the other interpersonal skills of a project manager in order to lead the team to a successful resolution of the situation in conflict.

X3.11 Coaching

Coaching is a means of developing the project team to higher levels of competency and performance. Coaching is about helping people recognize their potential through empowerment and development. Coaching is used to aid team members in developing or enhancing their skills or to build new skills required to enable project success. Coaching can take many forms and approaches. In some instances, formal or informal training may be developed to increase technical skills or assist team-building efforts and facilitate consistent interpersonal interactions.

Coaching is also used to address poor performance and to help team members overcome deficiencies in their skill sets. Coaching is distinct from counseling. Counseling focuses on addressing situations where team members “won’t do” something rather than “can’t do.” If the situation is one where the team member is not performing or meeting expectations due to a lack of skill, knowledge, or experience, coaching can be employed to help the team member to develop this skill and thus turn a “can’t do” situation into one of “can do.”

Coaching can be a powerful motivator for teams. As teams develop their skills, abilities, and confidence, their willingness to take on challenging or demanding tasks is increased. This can lead to more effective and productive teams.

X3.12 References

Covey, S. R. “Seven Habits of Highly Effective People,” A Fireside Book, Simon and Schuster, New York, NY.

Dinsmore, P.C. “Human Factors in Project Management (Revised Edition),” American Management Association: New York, NY.

Levin, G. and Flannes, S. “Essential People Skills for Project Managers,” Management Concepts Inc., Vienna, VA.

Verma, V. K. “Organizing Projects for Success,” PMI, Newtown Square, PA.

Verma, V. K. “Human Resource Skills for the Project Manager,” PMI, Newtown Square, PA.

Verma, V. K. “Managing the Project Team,” PMI, Newtown Square, PA.

REFERENCES

- [1] Project Management Institute. 2012. *PMI Lexicon of Project Management Terms*. Available from <http://www.pmi.org/lexiconterms>
- [2] Project Management Institute. *PMI Code of Ethics and Professional Conduct*. Available from <http://www.pmi.org/codeofethicsPDF>
- [3] Project Management Institute. 2013. *The Standard for Program Management – Third Edition*. Newtown Square, PA: PMI.
- [4] Project Management Institute. 2013. *The Standard for Portfolio Management – Third Edition*. Newtown Square, PA: PMI.
- [5] Project Management Institute. 2013. *Organizational Project Management Maturity Model (OPM3®) – Third Edition*. Newtown Square, PA: PMI.
- [6] International Standards Organization. 2008. ISO/IEC 15288:2008. *Systems and Software Engineering – System Life Cycle Processes*. Geneva, Switzerland: ISO.
- [7] Project Management Institute. 2006. *Practice Standard for Work Breakdown Structures (WBS) – Second Edition (Reaffirmed)*. Newtown Square, PA: PMI.
- [8] Project Management Institute. 2011. *Practice Standard for Scheduling – Second Edition*. Newtown Square, PA: PMI.
- [9] Project Management Institute. 2011. *Practice Standard for Earned Value Management – Second Edition*. Newtown Square, PA: PMI.
- [10] International Standards Organization. 2008. ISO 9000:2008. *Quality Management Systems – Fundamentals and Vocabulary*. Geneva, Switzerland: ISO.
- [11] International Standards Organization. 2004. ISO/IEC 2:2004. *Standardization and Related Activities– General Vocabulary*. Geneva, Switzerland: ISO.
- [12] International Standards Organization. 2012. ISO 21500:2012 *Guidance on Project Management*. Geneva, Switzerland: ISO.

GLOSSARY

1. Inclusions and Exclusions

This glossary includes terms that are:

- Unique or nearly unique to project management (e.g., project scope statement, work package, work breakdown structure, critical path method).
- Not unique to project management, but used differently or with a narrower meaning in project management than in general everyday usage (e.g., early start date,).

This glossary generally does not include:

- Application area-specific terms.
- Terms used in project management which do not differ in any material way from everyday use (e.g., calendar day, delay).
- Compound terms whose meaning is clear from the combined meanings of the component parts.
- Variants when the meaning of the variant is clear from the base term.

As a result of the above inclusions and exclusions, this glossary includes:

- A preponderance of terms related to Project Scope Management, Project Time Management, and Project Risk Management, since many of the terms used in these Knowledge Areas are unique or nearly unique to project management.
- Many terms from Project Quality Management, since these terms are used more narrowly than in their everyday usage.
- Relatively few terms related to Project Human Resource Management, Project Communications Management, and Project Stakeholder Management, since most of the terms used in these Knowledge Areas do not differ significantly from everyday usage.
- Relatively few terms related to Project Cost Management, Project Integration Management, and Project Procurement Management, since many of the terms used in these Knowledge Areas have narrow meanings that are unique to a particular application area.

2. Common Acronyms

AC	actual cost
ACWP	actual cost of work performed
BAC	budget at completion
CCB	change control board
COQ	cost of quality
CPAF	cost plus award fee
CPFF	cost plus fixed fee
CPI	cost performance index
CPIF	cost plus incentive fee
CPM	critical path methodology
CV	cost variance
EAC	estimate at completion
EF	early finish date
EMV	expected monetary value
ES	early start date
ETC	estimate to complete
EV	earned value
EVM	earned value management
FF	finish-to-finish
FFP	firm fixed price contract
FMEA	failure mode and effect analysis
FP-EPA	fixed price with economic price adjustment
FPIF	fixed price incentive fee
FS	finish to start

IFB	invitation for bid
LF	late finish date
LOE	level of effort
LS	late start date
OBS	organizational breakdown structure
PDM	precedence diagramming method
PMBOK	Project Management Body of Knowledge
PV	planned value
QFD	quality function deployment
RACI	responsible, accountable, consult, and inform
RAM	responsibility assignment matrix
RBS	risk breakdown structure
RFI	request for information
RFP	request for proposal
RFQ	request for quotation
SF	start-to-finish
SOW	statement of work
SPI	schedule performance index
SS	start-to-start
SV	schedule variance
SWOT	strengths, weaknesses, opportunities, and threats
T&M	time and material contract
WBS	work breakdown structure

3. Definitions

Many of the words defined here have broader, and in some cases different, dictionary definitions.

The definitions use the following conventions:

- In some cases, a single glossary term consists of multiple words (e.g., risk urgency assessment).
- When synonyms are included, no definition is given and the reader is directed to the preferred term (i.e., see preferred term).
- Related terms that are not synonyms are cross-referenced at the end of the definition (i.e., see also related term).

Acceptance Criteria. A set of conditions that is required to be met before deliverables are accepted.

Accepted Deliverables. Products, results, or capabilities produced by a project and validated by the project customer or sponsors as meeting their specified acceptance criteria.

Accuracy. Within the quality management system, *accuracy* is an assessment of correctness.

Acquire Project Team. The process of confirming human resource availability and obtaining the team necessary to complete project activities.

Acquisition. Obtaining human and material resources necessary to perform project activities. Acquisition implies a cost of resources, and is not necessarily financial.

Activity. A distinct, scheduled portion of work performed during the course of a project.

Activity Attributes. Multiple attributes associated with each schedule activity that can be included within the activity list. Activity attributes include activity codes, predecessor activities, successor activities, logical relationships, leads and lags, resource requirements, imposed dates, constraints, and assumptions.

Activity Code. One or more numerical or text values that identify characteristics of the work or in some way categorize the schedule activity that allows filtering and ordering of activities within reports.

Activity Cost Estimates. The projected cost of the schedule activity that includes the cost for all resources required to perform and complete the activity, including all cost types and cost components.

Activity Duration. The time in calendar units between the start and finish of a schedule activity. See also *duration*.

Activity Duration Estimate. A quantitative assessment of the likely amount or outcome for the duration of an activity.

Activity Identifier. A short, unique numeric or text identification assigned to each schedule activity to differentiate that project activity from other activities. Typically unique within any one project schedule network diagram.

Activity List. A documented tabulation of schedule activities that shows the activity description, activity identifier, and a sufficiently detailed scope of work description so project team members understand what work is to be performed.

Activity Network Diagrams. See *project schedule network diagram*.

Activity-on-Node (AON). See *precedence diagramming method (PDM)*.

Activity Resource Requirements. The types and quantities of resources required for each activity in a work package.

Actual Cost (AC). The realized cost incurred for the work performed on an activity during a specific time period.

Actual Duration. The time in calendar units between the actual start date of the schedule activity and either the data date of the project schedule if the schedule activity is in progress or the actual finish date if the schedule activity is complete.

Adaptive Life Cycle. A project life cycle, also known as change-driven or agile methods, that is intended to facilitate change and require a high degree of ongoing stakeholder involvement. Adaptive life cycles are also iterative and incremental, but differ in that iterations are very rapid (usually 2–4 weeks in length) and are fixed in time and resources.

Additional Quality Planning Tools. A set of tools used to define the quality requirements and to plan effective quality management activities. They include, but are not limited to: brainstorming, force field analysis, nominal group techniques and quality management and control tools.

Adjusting Leads and Lags. A technique used to find ways to bring project activities that are behind into alignment with plan during project execution.

Advertising. The process of calling public attention to a project or effort.

Affinity Diagram. A group creativity technique that allows large numbers of ideas to be classified into groups for review and analysis.

Agreements. Any document or communication that defines the initial intentions of a project. This can take the form of a contract, memorandum of understanding (MOU), letters of agreement, verbal agreements, email, etc.

Alternative Analysis. A technique used to evaluate identified options in order to select which options or approaches to use to execute and perform the work of the project.

Alternatives Generation. A technique used to develop as many potential options as possible in order to identify different approaches to execute and perform the work of the project.

Analogous Estimating. A technique for estimating the duration or cost of an activity or a project using historical data from a similar activity or project.

Analytical Techniques. Various techniques used to evaluate, analyze, or forecast potential outcomes based on possible variations of project or environmental variables and their relationships with other variables.

Application Area. A category of projects that have common components significant in such projects, but are not needed or present in all projects. Application areas are usually defined in terms of either the product (i.e., by similar technologies or production methods) or the type of customer (i.e., internal versus external, government versus commercial) or industry sector (i.e., utilities, automotive, aerospace, information technologies, etc.). Application areas can overlap.

Applying Leads and Lags. A technique that is used to adjust the amount of time between predecessor and successor activities.

Apportioned Effort. An activity where effort is allotted proportionately across certain discrete efforts and not divisible into discrete efforts. [Note: Apportioned effort is one of three earned value management (EVM) types of activities used to measure work performance.]

Approved Change Request. A change request that has been processed through the integrated change control process and approved.

Approved Change Requests Review. A review of the change requests to verify that these were implemented as approved.

Assumption. A factor in the planning process that is considered to be true, real, or certain, without proof or demonstration.

Assumptions Analysis. A technique that explores the accuracy of assumptions and identifies risks to the project from inaccuracy, inconsistency, or incompleteness of assumptions.

Attribute Sampling. Method of measuring quality that consists of noting the presence (or absence) of some characteristic (attribute) in each of the units under consideration. After each unit is inspected, the decision is made to accept a lot, reject it, or inspect another unit.

Authority. The right to apply project resources, expend funds, make decisions, or give approvals.

Backlog. A listing of product requirements and deliverables to be completed, written as stories, and prioritized by the business to manage and organize the project's work.

Backward Pass. A critical path method technique for calculating the late start and late finish dates by working backward through the schedule model from the project end date.

Bar Chart. A graphic display of schedule-related information. In the typical bar chart, schedule activities or work breakdown structure components are listed down the left side of the chart, dates are shown across the top, and activity durations are shown as date-placed horizontal bars. See also *Gantt chart*.

Baseline. The approved version of a work product that can be changed only through formal change control procedures and is used as a basis for comparison.

Basis of Estimates. Supporting documentation outlining the details used in establishing project estimates such as assumptions, constraints, level of detail, ranges, and confidence levels.

Benchmarking. Benchmarking is the comparison of actual or planned practices, such as processes and operations, to those of comparable organizations to identify best practices, generate ideas for improvement, and provide a basis for measuring performance.

Bidder Conference. The meetings with prospective sellers prior to the preparation of a bid or proposal to ensure all prospective vendors have a clear and common understanding of the procurement. Also known as contractor conferences, vendor conferences, or pre-bid conferences.

Bottom-Up Estimating. A method of estimating project duration or cost by aggregating the estimates of the lower-level components of the work breakdown structure (WBS).

Brainstorming. A general data gathering and creativity technique that can be used to identify risks, ideas, or solutions to issues by using a group of team members or subject matter experts.

Budget. The approved estimate for the project or any work breakdown structure component or any schedule activity.

Budget at Completion (BAC). The sum of all budgets established for the work to be performed.

Buffer. See *reserve*.

Business Case. A documented economic feasibility study used to establish validity of the benefits of a selected component lacking sufficient definition and that is used as a basis for the authorization of further project management activities.

Business Value. A concept that is unique to each organization and includes tangible and intangible elements. Through the effective use of project, program, and portfolio management disciplines, organizations will possess the ability to employ reliable, established processes to meet enterprise objectives and obtain greater business value from their investments.

Buyer. The acquirer of products, services, or results for an organization.

Cause and Effect Diagram. A decomposition technique that helps trace an undesirable effect back to its root cause.

Central Tendency. A property of the central limit theorem predicting that the data observations in a distribution will tend to group around a central location. The three typical measures of central tendency are the mean, median, and mode.

Change Control. A process whereby modifications to documents, deliverables, or baselines associated with the project are identified, documented, approved, or rejected.

Change Control Board (CCB). A formally chartered group responsible for reviewing, evaluating, approving, delaying, or rejecting changes to the project, and for recording and communicating such decisions.

Change Control System. A set of procedures that describes how modifications to the project deliverables and documentation are managed and controlled.

Change Control Tools. Manual or automated tools to assist with change and/or configuration management. At a minimum, the tools should support the activities of the CCB.

Change Log. A comprehensive list of changes made during the project. This typically includes dates of the change and impacts in terms of time, cost, and risk.

Change Request. A formal proposal to modify any document, deliverable, or baseline.

Charter. See *project charter*.

Checklist Analysis. A technique for systematically reviewing materials using a list for accuracy and completeness.

Checksheets. A tally sheet that can be used as a checklist when gathering data.

Claim. A request, demand, or assertion of rights by a seller against a buyer, or vice versa, for consideration, compensation, or payment under the terms of a legally binding contract, such as for a disputed change.

Claims Administration. The process of processing, adjudicating, and communicating contract claims.

Close Procurements. The process of completing each project procurement.

Close Project or Phase. The process of finalizing all activities across all of the Project Management Process Groups to formally complete a project or phase.

Closed Procurements. Project contracts or other procurement agreements that have been formally acknowledged by the proper authorizing agent as being finalized and signed off.

Closing Process Group. Those processes performed to finalize all activities across all Process Groups to formally close a project or phase.

Code of Accounts. A numbering system used to uniquely identify each component of the work breakdown structure (WBS).

Collect Requirements. The process of determining, documenting, and managing stakeholder needs and requirements to meet project objectives.

Colocation. An organizational placement strategy where the project team members are physically located close to one another in order to improve communication, working relationships, and productivity.

Communication Constraints. Restrictions on the content, timing, audience, or individual who will deliver a communication usually stemming from specific legislation or regulation, technology, or organizational policies.

Communication Methods. A systematic procedure, technique, or process used to transfer information among project stakeholders.

Communication Models. A description, analogy or schematic used to represent how the communication process will be performed for the project.

Communication Requirements Analysis. An analytical technique to determine the information needs of the project stakeholders through interviews, workshops, study of lessons learned from previous projects, etc.

Communication Technology. Specific tools, systems, computer programs, etc., used to transfer information among project stakeholders.

Communications Management Plan. A component of the project, program, or portfolio management plan that describes how, when, and by whom information about the project will be administered and disseminated.

Compliance. A general concept of conforming to a rule, standard, law, or requirement such that the assessment of compliance results in a binomial result stated as “compliant” or “noncompliant.”

Conduct Procurements. The process of obtaining seller responses, selecting a seller, and awarding a contract.

Configuration Management System. A subsystem of the overall project management system. It is a collection of formal documented procedures used to apply technical and administrative direction and surveillance to: identify and document the functional and physical characteristics of a product, result, service, or component; control any changes to such characteristics; record and report each change and its implementation status; and support the audit of the products, results, or components to verify conformance to requirements. It includes the documentation, tracking systems, and defined approval levels necessary for authorizing and controlling changes.

Conflict Management. Handling, controlling, and guiding a conflictual situation to achieve a resolution.

Conformance. Within the quality management system, conformance is a general concept of delivering results that fall within the limits that define acceptable variation for a quality requirement.

Conformance Work. In the cost of quality framework, conformance work is done to compensate for imperfections that prevent organizations from completing planned activities correctly as essential first-time work. Conformance work consists of actions that are related to prevention and inspection.

Constraint. A limiting factor that affects the execution of a project, program, portfolio, or process.

Context Diagrams. A visual depiction of the product scope showing a business system (process, equipment, computer system, etc.), and how people and other systems (actors) interact with it.

Contingency. An event or occurrence that could affect the execution of the project that may be accounted for with a reserve.

Contingency Allowance. See *reserve*.

Contingency Reserve. Budget within the cost baseline or performance measurement baseline that is allocated for identified risks that are accepted and for which contingent or mitigating responses are developed.

Contingent Response Strategies. Responses provided which may be used in the event that a specific trigger occurs.

Contract. A contract is a mutually binding agreement that obligates the seller to provide the specified product or service or result and obligates the buyer to pay for it.

Contract Change Control System. The system used to collect, track, adjudicate, and communicate changes to a contract.

Control. Comparing actual performance with planned performance, analyzing variances, assessing trends to effect process improvements, evaluating possible alternatives, and recommending appropriate corrective action as needed.

Control Account. A management control point where scope, budget, actual cost, and schedule are integrated and compared to earned value for performance measurement.

Control Chart. A graphic display of process data over time and against established control limits, which has a centerline that assists in detecting a trend of plotted values toward either control limit.

Control Communications. The process of monitoring and controlling communications throughout the entire project life cycle to ensure the information needs of the project stakeholders are met.

Control Costs. The process of monitoring the status of the project to update the project costs and managing changes to the cost baseline.

Control Limits. The area composed of three standard deviations on either side of the centerline or mean of a normal distribution of data plotted on a control chart, which reflects the expected variation in the data. See also *specification limits*.

Control Procurements. The process of managing procurement relationships, monitoring contract performance, and making changes and corrections as appropriate.

Control Quality. The process of monitoring and recording results of executing the quality activities to assess performance and recommend necessary changes.

Control Risks. The process of implementing risk response plans, tracking identified risks, monitoring residual risks, identifying new risks, and evaluating risk process effectiveness throughout the project.

Control Schedule. The process of monitoring the status of project activities to update project progress and manage changes to the schedule baseline to achieve the plan.

Control Scope. The process of monitoring the status of the project and product scope and managing changes to the scope baseline.

Control Stakeholder Engagement. The process of monitoring overall project stakeholder relationships and adjusting strategies and plans for engaging stakeholders.

Corrective Action. An intentional activity that realigns the performance of the project work with the project management plan.

Cost Aggregation. Summing the lower-level cost estimates associated with the various work packages for a given level within the project's WBS or for a given cost control account.

Cost Baseline. The approved version of the time-phased project budget, excluding any management reserves, which can be changed only through formal change control procedures and is used as a basis for comparison to actual results.

Cost Management Plan. A component of a project or program management plan that describes how costs will be planned, structured, and controlled.

Cost of Quality. A method of determining the costs incurred to ensure quality. Prevention and appraisal costs (cost of conformance) include costs for quality planning, quality control (QC), and quality assurance to ensure compliance to requirements (i.e., training, QC systems, etc.). Failure costs (cost of nonconformance) include costs to rework products, components, or processes that are non-compliant, costs of warranty work and waste, and loss of reputation.

Cost Performance Index (CPI). A measure of the cost efficiency of budgeted resources expressed as the ratio of earned value to actual cost.

Cost Plus Award Fee Contracts (CPAF). A category of contract that involves payments to the seller for all legitimate actual costs incurred for completed work, plus an award fee representing seller profit.

Cost Plus Fixed Fee Contract (CPFF). A type of cost-reimbursable contract where the buyer reimburses the seller for the seller's allowable costs (allowable costs are defined by the contract) plus a fixed amount of profit (fee).

Cost Plus Incentive Fee Contract (CPIF). A type of cost-reimbursable contract where the buyer reimburses the seller for the seller's allowable costs (allowable costs are defined by the contract), and the seller earns its profit if it meets defined performance criteria.

Cost Variance (CV). The amount of budget deficit or surplus at a given point in time, expressed as the difference between the earned value and the actual cost.

Cost-Benefit Analysis. A financial analysis tool used to determine the benefits provided by a project against its costs.

Cost-Reimbursable Contract. A type of contract involving payment to the seller for the seller's actual costs, plus a fee typically representing seller's profit. Cost-reimbursable contracts often include incentive clauses where, if the seller meets or exceeds selected project objectives, such as schedule targets or total cost, then the seller receives from the buyer an incentive or bonus payment.

Crashing. A technique used to shorten the schedule duration for the least incremental cost by adding resources.

Create WBS. The process of subdividing project deliverables and project work into smaller, more manageable components.

Criteria. Standards, rules, or tests on which a judgment or decision can be based or by which a product, service, result, or process can be evaluated.

Critical Chain Method. A schedule method that allows the project team to place buffers on any project schedule path to account for limited resources and project uncertainties.

Critical Path. The sequence of activities that represents the longest path through a project, which determines the shortest possible duration.

Critical Path Activity. Any activity on the critical path in a project schedule.

Critical Path Method. A method used to estimate the minimum project duration and determine the amount of scheduling flexibility on the logical network paths within the schedule model.

Customer. Customer is the person(s) or organization(s) that will pay for the project's product, service, or result. Customers can be internal or external to the performing organization.

Customer Satisfaction. Within the quality management system, a state of fulfillment in which the needs of a customer are met or exceeded for the customer's expected experiences as assessed by the customer at the moment of evaluation.

Data Date. A point in time when the status of the project is recorded.

Data Gathering and Representation Techniques. Techniques used to collect, organize, and present data and information.

Decision Tree Analysis. A diagramming and calculation technique for evaluating the implications of a chain of multiple options in the presence of uncertainty.

Decomposition. A technique used for dividing and subdividing the project scope and project deliverables into smaller, more manageable parts.

Defect. An imperfection or deficiency in a project component where that component does not meet its requirements or specifications and needs to be either repaired or replaced.

Defect Repair. An intentional activity to modify a nonconforming product or product component.

Define Activities. The process of identifying and documenting the specific actions to be performed to produce the project deliverables.

Define Scope. The process of developing a detailed description of the project and product.

Deliverable. Any unique and verifiable product, result, or capability to perform a service that is required to be produced to complete a process, phase, or project.

Delphi Technique. An information gathering technique used as a way to reach a consensus of experts on a subject. Experts on the subject participate in this technique anonymously. A facilitator uses a questionnaire to solicit ideas about the important project points related to the subject. The responses are summarized and are then recirculated to the experts for further comment. Consensus may be reached in a few rounds of this process. The Delphi technique helps reduce bias in the data and keeps any one person from having undue influence on the outcome.

Dependency. See *logical relationship*.

Dependency Determination. A technique used to identify the type of dependency that is used to create the logical relationships between predecessor and successor activities.

Design of Experiments. A statistical method for identifying which factors may influence specific variables of a product or process under development or in production.

Determine Budget. The process of aggregating the estimated costs of individual activities or work packages to establish an authorized cost baseline.

Develop Project Charter. The process of developing a document that formally authorizes the existence of a project and provides the project manager with the authority to apply organizational resources to project activities.

Develop Project Management Plan. The process of defining, preparing, and coordinating all subsidiary plans and integrating them into a comprehensive project management plan.

Develop Project Team. The process of improving competencies, team member interaction, and overall team environment to enhance project performance.

Develop Schedule. The process of analyzing activity sequences, durations, resource requirements, and schedule constraints to create the project schedule model.

Diagramming Techniques. Approaches to presenting information with logical linkages that aid in understanding.

Dictatorship. A group decision-making technique in which one individual makes the decision for the group.

Direct and Manage Project Work. The process of leading and performing the work defined in the project management plan and implementing approved changes to achieve the project's objectives.

Discrete Effort. An activity that can be planned and measured and that yields a specific output. [Note: Discrete effort is one of three earned value management (EVM) types of activities used to measure work performance.]

Discretionary Dependency. A relationship that is established based on knowledge of best practices within a particular application area or an aspect of the project where a specific sequence is desired.

Document Analysis. An elicitation technique that analyzes existing documentation and identifies information relevant to the requirements.

Documentation Reviews. The process of gathering a corpus of information and reviewing it to determine accuracy and completeness.

Duration (DU or DUR). The total number of work periods (not including holidays or other nonworking periods) required to complete a schedule activity or work breakdown structure component. Usually expressed as workdays or workweeks. Sometimes incorrectly equated with elapsed time. Contrast with *effort*.

Early Finish Date (EF). In the critical path method, the earliest possible point in time when the uncompleted portions of a schedule activity can finish based on the schedule network logic, the data date, and any schedule constraints.

Early Start Date (ES). In the critical path method, the earliest possible point in time when the uncompleted portions of a schedule activity can start based on the schedule network logic, the data date, and any schedule constraints.

Earned Value (EV). The measure of work performed expressed in terms of the budget authorized for that work.

Earned Value Management. A methodology that combines scope, schedule, and resource measurements to assess project performance and progress.

Effort. The number of labor units required to complete a schedule activity or work breakdown structure component, often expressed in hours, days, or weeks.

Emotional Intelligence. The capability to identify, assess, and manage the personal emotions of oneself and other people, as well as the collective emotions of groups of people.

Enterprise Environmental Factors. Conditions, not under the immediate control of the team, that influence, constrain, or direct the project, program, or portfolio.

Estimate. A quantitative assessment of the likely amount or outcome. Usually applied to project costs, resources, effort, and durations and is usually preceded by a modifier (i.e., preliminary, conceptual, feasibility, order-of-magnitude, definitive). It should always include some indication of accuracy (e.g., \pm x percent). See also *budget* and *cost*.

Estimate Activity Durations. The process of estimating the number of work periods needed to complete individual activities with estimated resources.

Estimate Activity Resources. The process of estimating the type and quantities of material, human resources, equipment, or supplies required to perform each activity.

Estimate at Completion (EAC). The expected total cost of completing all work expressed as the sum of the actual cost to date and the estimate to complete.

Estimate Costs. The process of developing an approximation of the monetary resources needed to complete project activities.

Estimate to Complete (ETC). The expected cost to finish all the remaining project work.

Execute. Directing, managing, performing, and accomplishing the project work; providing the deliverables; and providing work performance information.

Executing Process Group. Those processes performed to complete the work defined in the project management plan to satisfy the project specifications.

Expected Monetary Value (EMV) Analysis. A statistical technique that calculates the average outcome when the future includes scenarios that may or may not happen. A common use of this technique is within decision tree analysis.

Expert Judgment. Judgment provided based upon expertise in an application area, knowledge area, discipline, industry, etc., as appropriate for the activity being performed. Such expertise may be provided by any group or person with specialized education, knowledge, skill, experience, or training.

External Dependency. A relationship between project activities and non-project activities.

Facilitated Workshops. An elicitation technique using focused sessions that bring key cross-functional stakeholders together to define product requirements.

Failure Mode and Effect Analysis (FMEA). An analytical procedure in which each potential failure mode in every component of a product is analyzed to determine its effect on the reliability of that component and, by itself or in combination with other possible failure modes, on the reliability of the product or system and on the required function of the component; or the examination of a product (at the system and/or lower levels) for all ways that a failure may occur. For each potential failure, an estimate is made of its effect on the total system and of its impact. In addition, a review is undertaken of the action planned to minimize the probability of failure and to minimize its effects.

Fallback Plan. Fallback plans include an alternative set of actions and tasks available in the event that the primary plan needs to be abandoned because of issues, risks, or other causes.

Fast Tracking. A schedule compression technique in which activities or phases normally done in sequence are performed in parallel for at least a portion of their duration.

Fee. Represents profit as a component of compensation to a seller.

Finish Date. A point in time associated with a schedule activity's completion. Usually qualified by one of the following: actual, planned, estimated, scheduled, early, late, baseline, target, or current.

Finish-to-Finish (FF). A logical relationship in which a successor activity cannot finish until a predecessor activity has finished.

Finish-to-Start (FS). A logical relationship in which a successor activity cannot start until a predecessor activity has finished.

Firm-Fixed-Price Contract (FFP). A type of fixed price contract where the buyer pays the seller a set amount (as defined by the contract), regardless of the seller's costs.

Fishbone diagram. See *Cause and Effect Diagram*.

Fixed Formula Method. An earned value method for assigning a specified percentage of budget value for a work package to the start milestone of the work package with the remaining budget value percentage assigned when the work package is complete.

Fixed Price Incentive Fee Contract (FPIF). A type of contract where the buyer pays the seller a set amount (as defined by the contract), and the seller can earn an additional amount if the seller meets defined performance criteria.

Fixed Price with Economic Price Adjustment Contracts (FP-EPA). A fixed-price contract, but with a special provision allowing for predefined final adjustments to the contract price due to changed conditions, such as inflation changes, or cost increases (or decreases) for specific commodities.

Fixed-Price Contracts. An agreement that sets the fee that will be paid for a defined scope of work regardless of the cost or effort to deliver it.

Float. Also called slack. See *total float* and *free float*.

Flowchart. The depiction in a diagram format of the inputs, process actions, and outputs of one or more processes within a system.

Focus Groups. An elicitation technique that brings together prequalified stakeholders and subject matter experts to learn about their expectations and attitudes about a proposed product, service, or result.

Forecast. An estimate or prediction of conditions and events in the project's future based on information and knowledge available at the time of the forecast. The information is based on the project's past performance and expected future performance, and includes information that could impact the project in the future, such as estimate at completion and estimate to complete.

Forward Pass. A critical path method technique for calculating the early start and early finish dates by working forward through the schedule model from the project start date or a given point in time.

Free Float. The amount of time that a schedule activity can be delayed without delaying the early start date of any successor or violating a schedule constraint.

Functional Manager. Someone with management authority over an organizational unit within a functional organization. The manager of any group that actually makes a product or performs a service. Sometimes called a line manager.

Functional Organization. A hierarchical organization where each employee has one clear superior, and staff are grouped by areas of specialization and managed by a person with expertise in that area.

Funding Limit Reconciliation. The process of comparing the planned expenditure of project funds against any limits on the commitment of funds for the project to identify any variances between the funding limits and the planned expenditures.

Gantt Chart. A bar chart of schedule information where activities are listed on the vertical axis, dates are shown on the horizontal axis, and activity durations are shown as horizontal bars placed according to start and finish dates.

Grade. A category or rank used to distinguish items that have the same functional use (e.g., “hammer”) but do not share the same requirements for quality (e.g., different hammers may need to withstand different amounts of force).

Ground Rules. Expectations regarding acceptable behavior by project team members.

Group Creativity Techniques. Techniques that are used to generate ideas within a group of stakeholders.

Group Decision-Making Techniques. Techniques to assess multiple alternatives that will be used to generate, classify, and prioritize product requirements.

Guideline. An official recommendation or advice that indicates policies, standards, or procedures for how something should be accomplished.

Hammock Activity. See *summary activity*.

Hard Logic. See *mandatory dependency*.

Histogram. A special form of bar chart used to describe the central tendency, dispersion, and shape of a statistical distribution.

Historical Information. Documents and data on prior projects including project files, records, correspondence, closed contracts, and closed projects.

Human Resource Management Plan. A component of the project management plan that describes how the roles and responsibilities, reporting relationships, and staff management will be addressed and structured.

Idea/Mind Mapping. Technique used to consolidate ideas created through individual brainstorming sessions into a single map to reflect commonality and differences in understanding and to generate new ideas.

Identify Risks. The process of determining which risks may affect the project and documenting their characteristics.

Identify Stakeholders. The process of identifying the people, groups, or organizations that could impact or be impacted by a decision, activity, or outcome of the project; and analyzing and documenting relevant information regarding their interests, involvement, interdependencies, influence, and potential impact on project success.

Imposed Date. A fixed date imposed on a schedule activity or schedule milestone, usually in the form of a “start no earlier than” and “finish no later than” date.

Incentive Fee. A set of financial incentives related to cost, schedule, or technical performance of the seller.

Incremental Life Cycle. A project life cycle where the project scope is generally determined early in the project life cycle, but time and cost estimates are routinely modified as the project team’s understanding of the product increases. Iterations develop the product through a series of repeated cycles, while increments successively add to the functionality of the product.

Independent Estimates. A process of using a third party to obtain and analyze information to support prediction of cost, schedule, or other items.

Influence Diagram. A graphical representation of situations showing causal influences, time ordering of events, and other relationships among variables and outcomes.

Information Gathering Techniques. Repeatable processes used to assemble and organize data across a spectrum of sources.

Information Management Systems. Facilities, processes, and procedures used to collect, store, and distribute information between producers and consumers of information in physical or electronic format.

Initiating Process Group. Those processes performed to define a new project or a new phase of an existing project by obtaining authorization to start the project or phase.

Input. Any item, whether internal or external to the project that is required by a process before that process proceeds. May be an output from a predecessor process.

Inspection. Examining or measuring to verify whether an activity, component, product, result, or service conforms to specified requirements.

Inspections and Audits. A process to observe performance of contracted work or a promised product against agreed-upon requirements.

Interpersonal Skills. Ability to establish and maintain relationships with other people.

Interrelationship Digraphs. A quality management planning tool, the interrelationship digraphs provide a process for creative problem-solving in moderately complex scenarios that possess intertwined logical relationships.

Interviews. A formal or informal approach to elicit information from stakeholders by talking to them directly.

Invitation for Bid (IFB). Generally, this term is equivalent to request for proposal. However, in some application areas, it may have a narrower or more specific meaning.

Issue. A point or matter in question or in dispute, or a point or matter that is not settled and is under discussion or over which there are opposing views or disagreements.

Issue Log. A project document used to document and monitor elements under discussion or in dispute between project stakeholders.

Iterative Life Cycle. A project life cycle where the project scope is generally determined early in the project life cycle, but time and cost estimates are routinely modified as the project team's understanding of the product increases. Iterations develop the product through a series of repeated cycles, while increments successively add to the functionality of the product.

Lag. The amount of time whereby a successor activity is required to be delayed with respect to a predecessor activity.

Late Finish Date (LF). In the critical path method, the latest possible point in time when the uncompleted portions of a schedule activity can finish based on the schedule network logic, the project completion date, and any schedule constraints.

Late Start Date (LS). In the critical path method, the latest possible point in time when the uncompleted portions of a schedule activity can start based on the schedule network logic, the project completion date, and any schedule constraints.

Lead. The amount of time whereby a successor activity can be advanced with respect to a predecessor activity.

Lessons Learned. The knowledge gained during a project which shows how project events were addressed or should be addressed in the future with the purpose of improving future performance.

Lessons Learned Knowledge Base. A store of historical information and lessons learned about both the outcomes of previous project selection decisions and previous project performance.

Level of Effort (LOE). An activity that does not produce definitive end products and is measured by the passage of time. [Note: Level of effort is one of three earned valued management (EVM) types of activities used to measure work performance.]

Leveling. See *resource leveling*.

Life Cycle. See *project life cycle*.

Log. A document used to record and describe or denote selected items identified during execution of a process or activity. Usually used with a modifier, such as issue, quality control, action, or defect.

Logical Relationship. A dependency between two activities, or between an activity and a milestone.

Majority. Support from more than 50 percent of the members of the group.

Make-or-Buy Analysis. The process of gathering and organizing data about product requirements and analyzing them against available alternatives including the purchase or internal manufacture of the product.

Make-or-Buy Decisions. Decisions made regarding the external purchase or internal manufacture of a product.

Manage Communications. The process of creating, collecting, distributing, storing, retrieving, and the ultimate disposition of project information in accordance with the communications management plan.

Manage Project Team. The process of tracking team member performance, providing feedback, resolving issues, and managing team changes to optimize project performance.

Manage Stakeholder Engagement. The process of communicating and working with stakeholders to meet their needs/expectations, address issues as they occur, and foster appropriate stakeholder engagement in project activities throughout the project life cycle.

Management Reserve. An amount of the project budget withheld for management control purposes. These are budgets reserved for unforeseen work that is within scope of the project. The management reserve is not included in the performance measurement baseline (PMB).

Management Skills. The ability to plan, organize, direct, and control individuals or groups of people to achieve specific goals.

Mandatory Dependency. A relationship that is contractually required or inherent in the nature of the work.

Market Research. The process of gathering information at conferences, online reviews, and a variety of sources to identify market capabilities.

Master Schedule. A summary-level project schedule that identifies the major deliverables and work breakdown structure components and key schedule milestones. See also *milestone schedule*.

Material. The aggregate of things used by an organization in any undertaking, such as equipment, apparatus, tools, machinery, gear, material, and supplies.

Matrix Diagrams. A quality management and control tool used to perform data analysis within the organizational structure created in the matrix. The matrix diagram seeks to show the strength of relationships between factors, causes, and objectives that exist between the rows and columns that form the matrix.

Matrix Organization. Any organizational structure in which the project manager shares responsibility with the functional managers for assigning priorities and for directing the work of persons assigned to the project.

Methodology. A system of practices, techniques, procedures, and rules used by those who work in a discipline.

Milestone. A significant point or event in a project, program, or portfolio.

Milestone List. A list identifying all project milestones and normally indicates whether the milestone is mandatory or optional.

Milestone Schedule. A summary-level schedule that identifies the major schedule milestones. See also *master schedule*.

Monitor. Collect project performance data with respect to a plan, produce performance measures, and report and disseminate performance information.

Monitor and Control Project Work. The process of tracking, reviewing, and reporting the progress to meet the performance objectives defined in the project management plan.

Monitoring and Controlling Process Group. Those processes required to track, review, and regulate the progress and performance of the project; identify any areas in which changes to the plan are required; and initiate the corresponding changes.

Monte Carlo Simulation. A process which generates hundreds or thousands of probable performance outcomes based on probability distributions for cost and schedule on individual tasks. The outcomes are then used to generate a probability distribution for the project as a whole.

Most Likely Duration. An estimate of the most probable activity duration that takes into account all of the known variables that could affect performance.

Multi-Criteria Decision Analysis. This technique utilizes a decision matrix to provide a systematic analytical approach for establishing criteria, such as risk levels, uncertainty, and valuation, to evaluate and rank many ideas.

Near-Critical Activity. A schedule activity that has low total float. The concept of near-critical is equally applicable to a schedule activity or schedule network path. The limit below which total float is considered near critical is subject to expert judgment and varies from project to project.

Negotiated Settlements. The process of reaching final equitable settlement of all outstanding issues, claims, and disputes through negotiation.

Negotiation. The process and activities to resolving disputes through consultations between involved parties.

Network. See *project schedule network diagram*.

Network Analysis. See *schedule network analysis*.

Network Logic. The collection of schedule activity dependencies that makes up a project schedule network diagram.

Network Path. Any continuous series of schedule activities connected with logical relationships in a project schedule network diagram.

Networking. Establishing connections and relationships with other people from the same or other organizations.

Node. One of the defining points of a schedule network; a junction point joined to some or all of the other dependency lines.

Nominal Group Technique. A technique that enhances brainstorming with a voting process used to rank the most useful ideas for further brainstorming or for prioritization.

Nonconformance Work. In the cost of quality framework, nonconformance work is done to deal with the consequences of errors and failures in doing activities correctly on the first attempt. In efficient quality management systems, the amount of nonconformance work will approach zero.

Objective. Something toward which work is to be directed, a strategic position to be attained, a purpose to be achieved, a result to be obtained, a product to be produced, or a service to be performed.

Observations. A technique that provides a direct way of viewing individuals in their environment performing their jobs or tasks and carrying out processes.

Opportunity. A risk that would have a positive effect on one or more project objectives.

Optimistic Duration. An estimate of the shortest activity duration that takes into account all of the known variables that could affect performance.

Organizational Breakdown Structure (OBS). A hierarchical representation of the project organization that illustrates the relationship between project activities and the organizational units that will perform those activities.

Organizational Process Assets. Plans, processes, policies, procedures, and knowledge bases that are specific to and used by the performing organization.

Organizational Project Management Maturity. The level of an organization's ability to deliver the desired strategic outcomes in a predictable, controllable, and reliable manner.

Output. A product, result, or service generated by a process. May be an input to a successor process.

Parametric Estimating. An estimating technique in which an algorithm is used to calculate cost or duration based on historical data and project parameters.

Pareto Diagram. A histogram, ordered by frequency of occurrence, that shows how many results were generated by each identified cause.

Path Convergence. A relationship in which a schedule activity has more than one predecessor.

Path Divergence. A relationship in which a schedule activity has more than one successor.

Payment Systems. The system used to provide and track supplier's invoices and payments for services and products.

Percent Complete. An estimate expressed as a percent of the amount of work that has been completed on an activity or a work breakdown structure component.

Perform Integrated Change Control. The process of reviewing all change requests; approving changes and managing changes to deliverables, organizational process assets, project documents, and the project management plan; and communicating their disposition.

Perform Qualitative Risk Analysis. The process of prioritizing risks for further analysis or action by assessing and combining their probability of occurrence and impact.

Perform Quality Assurance. The process of auditing the quality requirements and the results from quality control measurements to ensure that appropriate quality standards and operational definitions are used.

Perform Quantitative Risk Analysis. The process of numerically analyzing the effect of identified risks on overall project objectives.

Performance Measurement Baseline. An approved, integrated scope-schedule-cost plan for the project work against which project execution is compared to measure and manage performance. The PMB includes contingency reserve, but excludes management reserve.

Performance Reporting. See *work performance reports*.

Performance Reports. See *work performance reports*.

Performance Reviews. A technique that is used to measure, compare, and analyze actual performance of work in progress on the project against the baseline.

Performing Organization. An enterprise whose personnel are most directly involved in doing the work of the project or program.

Pessimistic Duration. Estimate of the longest activity duration that takes into account all of the known variables that could affect performance.

Phase. See *project phase*.

Phase Gate. A review at the end of a phase in which a decision is made to continue to the next phase, to continue with modification, or to end a project or program.

Plan Communications Management. The process of developing an appropriate approach and plan for project communications based on stakeholder's information needs and requirements and available organizational assets.

Plan Cost Management. The process that establishes the policies, procedures, and documentation for planning, managing, expending, and controlling project costs.

Plan Human Resource Management. The process of identifying and documenting project roles, responsibilities, required skills, reporting relationships, and creating a staffing management plan.

Plan Procurement Management. The process of documenting project procurement decisions, specifying the approach, and identifying potential sellers.

Plan Quality Management. The process of identifying quality requirements and/or standards for the project and its deliverables, and documenting how the project will demonstrate compliance with quality requirements.

Plan Risk Management. The process of defining how to conduct risk management activities for a project.

Plan Risk Responses. The process of developing options and actions to enhance opportunities and to reduce threats to project objectives.

Plan Schedule Management. The process of establishing the policies, procedures, and documentation for planning, developing, managing, executing, and controlling the project schedule.

Plan Scope Management. The process of creating a scope management plan that documents how the project scope will be defined, validated, and controlled.

Plan Stakeholder Management. The process of developing appropriate management strategies to effectively engage stakeholders throughout the project life cycle, based on the analysis of their needs, interests, and potential impact on project success.

Planned Value (PV). The authorized budget assigned to scheduled work.

Planning Package. A work breakdown structure component below the control account with known work content but without detailed schedule activities. See also *control account*.

Planning Process Group. Those processes required to establish the scope of the project, refine the objectives, and define the course of action required to attain the objectives that the project was undertaken to achieve.

Plurality. Decisions made by the largest block in a group, even if a majority is not achieved.

Policy. A structured pattern of actions adopted by an organization such that the organization's policy can be explained as a set of basic principles that govern the organization's conduct.

Portfolio. Projects, programs, subportfolios, and operations managed as a group to achieve strategic objectives.

Portfolio Management. The centralized management of one or more portfolios to achieve strategic objectives.

Practice. A specific type of professional or management activity that contributes to the execution of a process and that may employ one or more techniques and tools.

Precedence Diagramming Method (PDM). A technique used for constructing a schedule model in which activities are represented by nodes and are graphically linked by one or more logical relationships to show the sequence in which the activities are to be performed.

Precedence Relationship. The term used in the precedence diagramming method for a logical relationship. In current usage, however, precedence relationship, logical relationship, and dependency are widely used interchangeably, regardless of the diagramming method used. See also *logical relationship*.

Precision. Within the quality management system, *precision* is a measure of exactness.

Predecessor Activity. An activity that logically comes before a dependent activity in a schedule.

Predictive Life Cycle. A form of project life cycle in which the project scope, and the time and cost required to deliver that scope, are determined as early in the life cycle as possible.

Preferential Logic. See *discretionary dependency*.

Preferred Logic. See *discretionary dependency*.

Preventive Action. An intentional activity that ensures the future performance of the project work is aligned with the project management plan.

Prioritization Matrices. A quality management planning tool used to identify key issues and evaluate suitable alternatives to define a set of implementation priorities.

Probability and Impact Matrix. A grid for mapping the probability of each risk occurrence and its impact on project objectives if that risk occurs.

Procedure. An established method of accomplishing a consistent performance or result, a procedure typically can be described as the sequence of steps that will be used to execute a process.

Process. A systematic series of activities directed towards causing an end result such that one or more inputs will be acted upon to create one or more outputs.

Process Analysis. A process analysis follows the steps outlined in the process improvement plan to identify needed improvements.

Process Decision Program Charts (PDPC). The PDPC is used to understand a goal in relation to the steps for getting to the goal.

Process Improvement Plan. A subsidiary plan of the project management plan. It details the steps for analyzing processes to identify activities that enhance their value.

Procurement Audits. The review of contracts and contracting processes for completeness, accuracy, and effectiveness.

Procurement Documents. The documents utilized in bid and proposal activities, which include the buyer's Invitation for Bid, Invitation for Negotiations, Request for Information, Request for Quotation, Request for Proposal, and seller's responses.

Procurement Management Plan. A component of the project or program management plan that describes how a project team will acquire goods and services from outside the performing organization.

Procurement Performance Reviews. A structured review of the seller's progress to deliver project scope and quality, within cost and on schedule, as compared to the contract.

Procurement Statement of Work. Describes the procurement item in sufficient detail to allow prospective sellers to determine if they are capable of providing the products, services, or results.

Product. An artifact that is produced, is quantifiable, and can be either an end item in itself or a component item. Additional words for products are material and goods. Contrast with *result*. See also *deliverable*.

Product Analysis. For projects that have a product as a deliverable, it is a tool to define scope that generally means asking questions about a product and forming answers to describe the use, characteristics, and other the relevant aspects of what is going to be manufactured.

Product Life Cycle. The series of phases that represent the evolution of a product, from concept through delivery, growth, maturity, and to retirement.

Product Scope. The features and functions that characterize a product, service, or result.

Product Scope Description. The documented narrative description of the product scope.

Program. A group of related projects, subprograms, and program activities managed in a coordinated way to obtain benefits not available from managing them individually.

Program Evaluation and Review Technique (PERT). A technique for estimating that applies a weighted average of optimistic, pessimistic, and most likely estimates when there is uncertainty with the individual activity estimates.

Program Management. The application of knowledge, skills, tools, and techniques to a program to meet the program requirements and to obtain benefits and control not available by managing projects individually.

Progressive Elaboration. The iterative process of increasing the level of detail in a project management plan as greater amounts of information and more accurate estimates become available.

Project. A temporary endeavor undertaken to create a unique product, service, or result.

Project-Based Organizations (PBOs). A variety of organizational forms that involve the creation of temporary systems for the performance of projects. PBOs conduct the majority of their activities as projects and/or provide project over functional approaches.

Project Calendar. A calendar that identifies working days and shifts that are available for scheduled activities.

Project Charter. A document issued by the project initiator or sponsor that formally authorizes the existence of a project and provides the project manager with the authority to apply organizational resources to project activities.

Project Communications Management. Project Communications Management includes the processes that are required to ensure timely and appropriate planning, collection, creation, distribution, storage, retrieval, management, control, monitoring, and the ultimate disposition of project information.

Project Cost Management. Project Cost Management includes the processes involved in planning, estimating, budgeting, financing, funding, managing, and controlling costs so that the project can be completed within the approved budget.

Project Funding Requirements. Forecast project costs to be paid that are derived from the cost baseline for total or periodic requirements, including projected expenditures plus anticipated liabilities.

Project Governance. The alignment of project objectives with the strategy of the larger organization by the project sponsor and project team. A project's governance is defined by and is required to fit within the larger context of the program or organization sponsoring it, but is separate from organizational governance.

Project Human Resource Management. Project Human Resource Management includes the processes that organize, manage, and lead the project team.

Project Initiation. Launching a process that can result in the authorization of a new project.

Project Integration Management. Project Integration Management includes the processes and activities needed to identify, define, combine, unify, and coordinate the various processes and project management activities within the Project Management Process Groups.

Project Life Cycle. The series of phases that a project passes through from its initiation to its closure.

Project Management. The application of knowledge, skills, tools, and techniques to project activities to meet the project requirements.

Project Management Body of Knowledge. An inclusive term that describes the sum of knowledge within the profession of project management. As with other professions, such as law, medicine, and accounting, the body of knowledge rests with the practitioners and academics that apply and advance it. The complete project management body of knowledge includes proven traditional practices that are widely applied and innovative practices that are emerging in the profession. The body of knowledge includes both published and unpublished materials. This body of knowledge is constantly evolving. PMI's *PMBOK*[®] Guide identifies a subset of the project management body of knowledge that is generally recognized as good practice.

Project Management Information System. An information system consisting of the tools and techniques used to gather, integrate, and disseminate the outputs of project management processes. It is used to support all aspects of the project from initiating through closing, and can include both manual and automated systems.

Project Management Knowledge Area. An identified area of project management defined by its knowledge requirements and described in terms of its component processes, practices, inputs, outputs, tools, and techniques.

Project Management Office (PMO). An organizational structure that standardizes the project-related governance processes and facilitates the sharing of resources, methodologies, tools, and techniques.

Project Management Plan. The document that describes how the project will be executed monitored, and controlled.

Project Management Process Group. A logical grouping of project management inputs, tools and techniques, and outputs. The Project Management Process Groups include initiating processes, planning processes, executing processes, monitoring and controlling processes, and closing processes. Project Management Process Groups are not project phases.

Project Management Staff. The members of the project team who perform project management activities such as schedule, communications, risk management, etc.

Project Management System. The aggregation of the processes, tools, techniques, methodologies, resources, and procedures to manage a project.

Project Management Team. The members of the project team who are directly involved in project management activities. On some smaller projects, the project management team may include virtually all of the project team members.

Project Manager (PM). The person assigned by the performing organization to lead the team that is responsible for achieving the project objectives.

Project Organization Chart. A document that graphically depicts the project team members and their interrelationships for a specific project.

Project Phase. A collection of logically related project activities that culminates in the completion of one or more deliverables.

Project Procurement Management. Project Procurement Management includes the processes necessary to purchase or acquire products, services, or results needed from outside the project team.

Project Quality Management. Project Quality Management includes the processes and activities of the performing organization that determine quality policies, objectives, and responsibilities so that the project will satisfy the needs for which it was undertaken.

Project Risk Management. Project Risk Management includes the processes of conducting risk management planning, identification, analysis, response planning, and controlling risk on a project.

Project Schedule. An output of a schedule model that presents linked activities with planned dates, durations, milestones, and resources.

Project Schedule Network Diagram. A graphical representation of the logical relationships among the project schedule activities.

Project Scope. The work performed to deliver a product, service, or result with the specified features and functions.

Project Scope Management. Project Scope Management includes the processes required to ensure that the project includes all the work required, and only the work required, to complete the project successfully.

Project Scope Statement. The description of the project scope, major deliverables, assumptions, and constraints.

Project Stakeholder Management. Project Stakeholder Management includes the processes required to identify all people or organizations impacted by the project, analyzing stakeholder expectations and impact on the project, and developing appropriate management strategies for effectively engaging stakeholders in project decisions and execution.

Project Statement of Work. See *statement of work*.

Project Team. A set of individuals who support the project manager in performing the work of the project to achieve its objectives.

Project Team Directory. A documented list of project team members, their project roles, and communication information.

Project Time Management. Project Time Management includes the processes required to manage the timely completion of the project.

Projectized Organization. Any organizational structure in which the project manager has full authority to assign priorities, apply resources, and direct the work of persons assigned to the project.

Proposal Evaluation Techniques. The process of reviewing proposals provided by suppliers to support contract award decisions.

Prototypes. A method of obtaining early feedback on requirements by providing a working model of the expected product before actually building it.

Quality. The degree to which a set of inherent characteristics fulfills requirements.

Quality Audits. A quality audit is a structured, independent process to determine if project activities comply with organizational and project policies, processes, and procedures.

Quality Checklists. A structured tool used to verify that a set of required steps has been performed.

Quality Control Measurements. The documented results of control quality activities.

Quality Function Deployment (QFD). A facilitated workshop technique that helps to determine critical characteristics for new product development.

Quality Management and Control Tools. They are a type of quality planning tools used to link and sequence the activities identified.

Quality Management Plan. A component of the project or program management plan that describes how an organization's quality policies will be implemented.

Quality Management System. The organizational framework whose structure provides the policies, processes, procedures, and resources required to implement the quality management plan. The typical project quality management plan should be compatible to the organization's quality management system.

Quality Metrics. A description of a project or product attribute and how to measure it.

Quality Policy. A policy specific to the Project Quality Management Knowledge Area, it establishes the basic principles that should govern the organization's actions as it implements its system for quality management.

Quality Requirement. A condition or capability that will be used to assess conformance by validating the acceptability of an attribute for the quality of a result.

Quantitative Risk Analysis and Modeling Techniques. Commonly used techniques for both event-oriented and project-oriented analysis approaches.

Questionnaires and Surveys. Written sets of questions designed to quickly accumulate information from a large number of respondents.

RACI. A common type of responsibility assignment matrix that uses responsible, accountable, consult, and inform statuses to define the involvement of stakeholders in project activities.

Records Management System. A specific set of processes, related control functions, and tools that are consolidated and combined to record and retain information about the project.

Regression Analysis. An analytic technique where a series of input variables are examined in relation to their corresponding output results in order to develop a mathematical or statistical relationship.

Regulation. Requirements imposed by a governmental body. These requirements can establish product, process, or service characteristics, including applicable administrative provisions that have government-mandated compliance.

Reporting Systems. Facilities, processes, and procedures used to generate or consolidate reports from one or more information management systems and facilitate report distribution to the project stakeholders.

Request for Information (RFI). A type of procurement document whereby the buyer requests a potential seller to provide various pieces of information related to a product or service or seller capability.

Request for Proposal (RFP). A type of procurement document used to request proposals from prospective sellers of products or services. In some application areas, it may have a narrower or more specific meaning.

Request for Quotation (RFQ). A type of procurement document used to request price quotations from prospective sellers of common or standard products or services. Sometimes used in place of request for proposal and, in some application areas, it may have a narrower or more specific meaning.

Requested Change. A formally documented change request that is submitted for approval to the integrated change control process.

Requirement. A condition or capability that is required to be present in a product, service, or result to satisfy a contract or other formally imposed specification.

Requirements Documentation. A description of how individual requirements meet the business need for the project.

Requirements Management Plan. A component of the project or program management plan that describes how requirements will be analyzed, documented, and managed.

Requirements Traceability Matrix. A grid that links product requirements from their origin to the deliverables that satisfy them.

Reserve. A provision in the project management plan to mitigate cost and/or schedule risk. Often used with a modifier (e.g., management reserve, contingency reserve) to provide further detail on what types of risk are meant to be mitigated.

Reserve Analysis. An analytical technique to determine the essential features and relationships of components in the project management plan to establish a reserve for the schedule duration, budget, estimated cost, or funds for a project.

Residual Risk. A risk that remains after risk responses have been implemented.

Resource. Skilled human resources (specific disciplines either individually or in crews or teams), equipment, services, supplies, commodities, material, budgets, or funds.

Resource Breakdown Structure. A hierarchical representation of resources by category and type.

Resource Calendar. A calendar that identifies the working days and shifts on which each specific resource is available.

Resource Histogram. A bar chart showing the amount of time that a resource is scheduled to work over a series of time periods. Resource availability may be depicted as a line for comparison purposes. Contrasting bars may show actual amounts of resources used as the project progresses.

Resource Leveling. A technique in which start and finish dates are adjusted based on resource constraints with the goal of balancing demand for resources with the available supply.

Resource Optimization Techniques. A technique that is used to adjust the start and finish dates of activities that adjust planned resource use to be equal to or less than resource availability.

Resource Smoothing. A technique which adjusts the activities of a schedule model such that the requirement for resources on the project do not exceed certain predefined resource limits.

Responsibility. An assignment that can be delegated within a project management plan such that the assigned resource incurs a duty to perform the requirements of the assignment.

Responsibility Assignment Matrix (RAM). A grid that shows the project resources assigned to each work package.

Result. An output from performing project management processes and activities. Results include outcomes (e.g., integrated systems, revised process, restructured organization, tests, trained personnel, etc.) and documents (e.g., policies, plans, studies, procedures, specifications, reports, etc.). Contrast with *product*. See also *deliverable*.

Rework. Action taken to bring a defective or nonconforming component into compliance with requirements or specifications.

Risk. An uncertain event or condition that, if it occurs, has a positive or negative effect on one or more project objectives.

Risk Acceptance. A risk response strategy whereby the project team decides to acknowledge the risk and not take any action unless the risk occurs.

Risk Appetite. The degree of uncertainty an entity is willing to take on, in anticipation of a reward.

Risk Audits. Examination and documentation of the effectiveness of risk responses in dealing with identified risks and their root causes, as well as the effectiveness of the risk management process.

Risk Avoidance. A risk response strategy whereby the project team acts to eliminate the threat or protect the project from its impact.

Risk Breakdown Structure (RBS). A hierarchical representation of risks according to their risk categories.

Risk Categorization. Organization by sources of risk (e.g., using the RBS), the area of the project affected (e.g., using the WBS), or other useful category (e.g., project phase) to determine the areas of the project most exposed to the effects of uncertainty.

Risk Category. A group of potential causes of risk.

Risk Data Quality Assessment. Technique to evaluate the degree to which the data about risks is useful for risk management.

Risk Management Plan. A component of the project, program, or portfolio management plan that describes how risk management activities will be structured and performed.

Risk Mitigation. A risk response strategy whereby the project team acts to reduce the probability of occurrence or impact of a risk.

Risk Reassessment. Risk reassessment is the identification of new risks, reassessment of current risks, and the closing of risks that are outdated.

Risk Register. A document in which the results of risk analysis and risk response planning are recorded.

Risk Threshold. Measure of the level of uncertainty or the level of impact at which a stakeholder may have a specific interest. Below that risk threshold, the organization will accept the risk. Above that risk threshold, the organization will not tolerate the risk.

Risk Tolerance. The degree, amount, or volume of risk that an organization or individual will withstand.

Risk Transference. A risk response strategy whereby the project team shifts the impact of a threat to a third party, together with ownership of the response.

Risk Urgency Assessment. Review and determination of the timing of actions that may need to occur sooner than other risk items.

Role. A defined function to be performed by a project team member, such as testing, filing, inspecting, or coding.

Rolling Wave Planning. An iterative planning technique in which the work to be accomplished in the near term is planned in detail, while the work in the future is planned at a higher level.

Root Cause Analysis. An analytical technique used to determine the basic underlying reason that causes a variance or a defect or a risk. A root cause may underlie more than one variance or defect or risk.

Scatter Diagram. A correlation chart that uses a regression line to explain or to predict how the change in an independent variable will change a dependent variable.

Schedule. See *project schedule* and see also *schedule model*.

Schedule Baseline. The approved version of a schedule model that can be changed only through formal change control procedures and is used as a basis for comparison to actual results.

Schedule Compression. Techniques used to shorten the schedule duration without reducing the project scope.

Schedule Data. The collection of information for describing and controlling the schedule.

Schedule Forecasts. Estimates or predictions of conditions and events in the project's future based on information and knowledge available at the time the schedule is calculated.

Schedule Management Plan. A component of the project management plan that establishes the criteria and the activities for developing, monitoring, and controlling the schedule.

Schedule Model. A representation of the plan for executing the project's activities including durations, dependencies, and other planning information, used to produce a project schedule along with other scheduling artifacts.

Schedule Network Analysis. The technique of identifying early and late start dates, as well as early and late finish dates, for the uncompleted portions of project schedule activities. See also *backward pass*, *critical path method*, *critical chain method*, and *resource leveling*.

Schedule Network Templates. A set of activities and relationships that have been established that can be used repeatedly for a particular application area or an aspect of the project where a prescribed sequence is desired.

Schedule Performance Index (SPI). A measure of schedule efficiency expressed as the ratio of earned value to planned value.

Schedule Variance (SV). A measure of schedule performance expressed as the difference between the earned value and the planned value.

Scheduling Tool. A tool that provides schedule component names, definitions, structural relationships, and formats that support the application of a scheduling method.

Scope. The sum of the products, services, and results to be provided as a project. See also *project scope* and *product scope*.

Scope Baseline. The approved version of a scope statement, work breakdown structure (WBS), and its associated WBS dictionary, that can be changed only through formal change control procedures and is used as a basis for comparison.

Scope Change. Any change to the project scope. A scope change almost always requires an adjustment to the project cost or schedule.

Scope Creep. The uncontrolled expansion to product or project scope without adjustments to time, cost, and resources.

Scope Management Plan. A component of the project or program management plan that describes how the scope will be defined, developed, monitored, controlled, and verified.

Secondary Risk. A risk that arises as a direct result of implementing a risk response.

Selected Sellers. The sellers which have been selected to provide a contracted set of services or products.

Seller. A provider or supplier of products, services, or results to an organization.

Seller Proposals. Formal responses from sellers to a request for proposal or other procurement document specifying the price, commercial terms of sale, and technical specifications or capabilities the seller will do for the requesting organization that, if accepted, would bind the seller to perform the resulting agreement.

Sensitivity Analysis. A quantitative risk analysis and modeling technique used to help determine which risks have the most potential impact on the project. It examines the extent to which the uncertainty of each project element affects the objective being examined when all other uncertain elements are held at their baseline values. The typical display of results is in the form of a tornado diagram.

Sequence Activities. The process of identifying and documenting relationships among the project activities.

Seven Basic Quality Tools. A standard toolkit used by quality management professionals who are responsible for planning, monitoring, and controlling the issues related to quality in an organization.

Simulation. A simulation uses a project model that translates the uncertainties specified at a detailed level into their potential impact on objectives that are expressed at the level of the total project. Project simulations use computer models and estimates of risk, usually expressed as a probability distribution of possible costs or durations at a detailed work level, and are typically performed using Monte Carlo analysis.

Soft Logic. See *discretionary dependency*.

Source Selection Criteria. A set of attributes desired by the buyer which a seller is required to meet or exceed to be selected for a contract.

Specification. A document that specifies, in a complete, precise, verifiable manner, the requirements, design, behavior, or other characteristics of a system, component, product, result, or service and the procedures for determining whether these provisions have been satisfied. Examples are: requirement specification, design specification, product specification, and test specification.

Specification Limits. The area, on either side of the centerline, or mean, of data plotted on a control chart that meets the customer's requirements for a product or service. This area may be greater than or less than the area defined by the control limits. See also *control limits*.

Sponsor. A person or group who provides resources and support for the project, program, or portfolio and is accountable for enabling success.

Sponsoring Organization. The entity responsible for providing the project's sponsor and a conduit for project funding or other project resources.

Staffing Management Plan. A component of the human resource plan that describes when and how project team members will be acquired and how long they will be needed.

Stakeholder. An individual, group, or organization who may affect, be affected by, or perceive itself to be affected by a decision, activity, or outcome of a project.

Stakeholder Analysis. A technique of systematically gathering and analyzing quantitative and qualitative information to determine whose interests should be taken into account throughout the project.

Stakeholder Management Plan. The stakeholder management plan is a subsidiary plan of the project management plan that defines the processes, procedures, tools, and techniques to effectively engage stakeholders in project decisions and execution based on the analysis of their needs, interests, and potential impact.

Stakeholder Register. A project document including the identification, assessment, and classification of project stakeholders.

Standard. A document that provides, for common and repeated use, rules, guidelines, or characteristics for activities or their results, aimed at the achievement of the optimum degree of order in a given context.

Start Date. A point in time associated with a schedule activity's start, usually qualified by one of the following: actual, planned, estimated, scheduled, early, late, target, baseline, or current.

Start-to-Finish (SF). A logical relationship in which a successor activity cannot finish until a predecessor activity has started.

Start-to-Start (SS). A logical relationship in which a successor activity cannot start until a predecessor activity has started.

Statement of Work (SOW). A narrative description of products, services, or results to be delivered by the project.

Statistical Sampling. Choosing part of a population of interest for inspection.

Subnetwork. A subdivision (fragment) of a project schedule network diagram, usually representing a subproject or a work package. Often used to illustrate or study some potential or proposed schedule condition, such as changes in preferential schedule logic or project scope.

Subproject. A smaller portion of the overall project created when a project is subdivided into more manageable components or pieces.

Successor Activity. A dependent activity that logically comes after another activity in a schedule.

Summary Activity. A group of related schedule activities aggregated and displayed as a single activity.

SWOT Analysis. Analysis of strengths, weaknesses, opportunities, and threats of an organization, project, or option.

Tailor. The act of carefully selecting process and related inputs and outputs contained within the *PMBOK*[®] Guide to determine a subset of specific processes that will be included within a project's overall management approach.

Team Members. *See project team members.*

Technique. A defined systematic procedure employed by a human resource to perform an activity to produce a product or result or deliver a service, and that may employ one or more tools.

Templates. A partially complete document in a predefined format that provides a defined structure for collecting, organizing, and presenting information and data.

Threat. A risk that would have a negative effect on one or more project objectives.

Three-Point Estimate. A technique used to estimate cost or duration by applying an average of optimistic, pessimistic, and most likely estimates when there is uncertainty with the individual activity estimates.

Threshold. A cost, time, quality, technical, or resource value used as a parameter, and which may be included in product specifications. Crossing the threshold should trigger some action, such as generating an exception report.

Time and Material Contract (T&M). A type of contract that is a hybrid contractual arrangement containing aspects of both cost-reimbursable and fixed-price contracts. Time and material contracts resemble cost-reimbursable type arrangements in that they have no definitive end, because the full value of the arrangement is not defined at the time of the award. Thus, time and material contracts can grow in contract value as if they were cost-reimbursable-type arrangements. Conversely, time and material arrangements can also resemble fixed-price arrangements. For example, the unit rates are preset by the buyer and seller, when both parties agree on the rates for the category of senior engineers.

Time-Scaled Schedule Network Diagram. Any project schedule network diagram drawn in such a way that the positioning and length of the schedule activity represents its duration. Essentially, it is a bar chart that includes schedule network logic.

To-Complete Performance Index (TCPI). A measure of the cost performance that is required to be achieved with the remaining resources in order to meet a specified management goal, expressed as the ratio of the cost to finish the outstanding work to the remaining budget.

Tolerance. The quantified description of acceptable variation for a quality requirement.

Tornado Diagram. A special type of bar chart used in sensitivity analysis for comparing the relative importance of the variables.

Tool. Something tangible, such as a template or software program, used in performing an activity to produce a product or result.

Total Float. The amount of time that a schedule activity can be delayed or extended from its early start date without delaying the project finish date or violating a schedule constraint.

Tree Diagram. A systematic diagram of a decomposition hierarchy used to visualize as parent-to-child relationships a systematic set of rules.

Trend Analysis. An analytical technique that uses mathematical models to forecast future outcomes based on historical results. It is a method of determining the variance from a baseline of a budget, cost, schedule, or scope parameter by using prior progress reporting periods' data and projecting how much that parameter's variance from baseline might be at some future point in the project if no changes are made in executing the project.

Trigger Condition. An event or situation that indicates that a risk is about to occur.

Unanimity. Agreement by everyone in the group on a single course of action.

Validate Scope. The process of formalizing acceptance of the completed project deliverables.

Validated Deliverables. Deliverables that are result of executing quality control process to determine correctness.

Validation. The assurance that a product, service, or system meets the needs of the customer and other identified stakeholders. It often involves acceptance and suitability with external customers. Contrast with *verification*.

Value Engineering. An approach used to optimize project life cycle costs, save time, increase profits, improve quality, expand market share, solve problems, and/or use resources more effectively.

Variance. A quantifiable deviation, departure, or divergence away from a known baseline or expected value.

Variance Analysis. A technique for determining the cause and degree of difference between the baseline and actual performance.

Variance at Completion (VAC). A projection of the amount of budget deficit or surplus, expressed as the difference between the budget at completion and the estimate at completion.

Variation. An actual condition that is different from the expected condition that is contained in the baseline plan.

Velocity. A measure of a team's productivity rate at which the deliverables are produced, validated, and accepted within a predefined interval. Velocity is a capacity planning approach frequently used to forecast future project work.

Verification. The evaluation of whether or not a product, service, or system complies with a regulation, requirement, specification, or imposed condition. It is often an internal process. Contrast with *validation*.

Voice of the Customer. A planning technique used to provide products, services, and results that truly reflect customer requirements by translating those customer requirements into the appropriate technical requirements for each phase of project product development.

WBS Dictionary. A document that provides detailed deliverable, activity, and scheduling information about each component in the work breakdown structure.

Weighted Milestone Method. An earned value method that divides a work package into measurable segments, each ending with an observable milestone, and then assigns a weighted value to the achievement of each milestone.

What-If Scenario Analysis. The process of evaluating scenarios in order to predict their effect on project objectives.

Work Authorization. A permission and direction, typically written, to begin work on a specific schedule activity or work package or control account. It is a method for sanctioning project work to ensure that the work is done by the identified organization, at the right time, and in the proper sequence.

Work Authorization System. A subsystem of the overall project management system. It is a collection of formal documented procedures that defines how project work will be authorized (committed) to ensure that the work is done by the identified organization, at the right time, and in the proper sequence. It includes the steps, documents, tracking system, and defined approval levels needed to issue work authorizations.

Work Breakdown Structure (WBS). A hierarchical decomposition of the total scope of work to be carried out by the project team to accomplish the project objectives and create the required deliverables.

Work Breakdown Structure Component. An entry in the work breakdown structure that can be at any level.

Work Package. The work defined at the lowest level of the work breakdown structure for which cost and duration can be estimated and managed.

Work Performance Data. The raw observations and measurements identified during activities being performed to carry out the project work.

Work Performance Information. The performance data collected from various controlling processes, analyzed in context and integrated based on relationships across areas.

Work Performance Reports. The physical or electronic representation of work performance information compiled in project documents, intended to generate decisions, actions, or awareness

Workaround. A response to a threat that has occurred, for which a prior response had not been planned or was not effective.

INDEX

A

- AC. *See* Actual cost
- Acceptance criteria, 123, 526
- Accepted deliverables. *See under* Deliverables
- Accuracy, 228, 526
 - level of, 148, 162, 170, 171, 175
- Acquire Project Team process, 255, 447, 526
 - inputs, 269
 - outputs, 272
 - overview, 267–269
 - tools and techniques, 270–272
- Acquisition, 270, 526
- Acquisition activities, 265
- Action item tracking, 27, 83, 91
- Activity, 526
- Activity attributes, 185, 526
 - as input, 155, 162, 167, 175
 - as output, 153
- Activity code, 526
- Activity cost estimates, 526
 - as input, 163, 210, 322, 361
 - as output, 207
- Activity duration, 526
- Activity duration estimate, 170, 527
 - See also* Estimate Activity Durations process
 - as input, 175, 322
 - range of possible results, 172
- Activity identifier (ID), 153, 527
- Activity list, 527
 - as input, 155, 162, 167, 175
 - as output, 152
- Activity network diagrams, 246
 - See also* Project schedule network diagram
- Activity on Arrow (AOA), 246
- Activity-on-Node (AON), 156, 246
 - See also* Precedence Diagramming Method
- Activity resource requirements, 185, 527
 - See also* Estimate Activity Resources process
 - as input, 167, 175, 259, 361
 - as output, 165
- Activity sequencing. *See* Sequence Activities process
- Actual cost (AC), 218, 219, 527
- Actual duration, 527
- Adaptive life cycles, 46, 527
- Additional quality planning tools, 240, 527
- Adjusting leads and lags, 527
- ADR. *See* Alternative dispute resolution
- Advertising, 376, 527
- AE. *See* Apportioned effort
- Affinity diagram, 115, 245, 528
- Agile approach, 1, 114, 187
- Agreements, 70, 528
 - See also* Collective bargaining agreements; Service level agreements
 - as input, 211, 382
 - as output, 377–378
- Alternative analysis, 164, 528
- Alternative dispute resolution (ADR), 378, 384, 388
- Alternatives generation, 123, 528
- American National Standards Institute (ANSI), 418
- Analogous estimating, 169–170, 204–205, 528
- Analytical techniques, 91–92, 103, 147–148, 198, 315, 376, 528
 - stakeholder engagement level, 402–403
- ANSI. *See* American National Standards Institute
- AON. *See* Activity-On-Node
- Application area, 528
- Applying leads and lags, 528
- Apportioned effort (AE), 528
- Approved change request, 96, 528
 - as input, 82, 251, 382
 - as output, 99

Approved change request review, 252, 528
 Arbitrary total float, 158
 Arbitration, 388
 Assumption(s), 124, 168, 348, 529
 Assumptions analysis, 325, 529
 Assumptions log updates, 333, 348
 Attribute sampling, 250, 529
 Audits, 135. *See also* Quality audits
 configuration verification and, 97
 inspections and, 383
 procurement, 388
 project success or failure, 101
 quality, 247, 556
 risk, 351, 354, 559
 Authority, 264, 529

B

BAC. *See* Budget at completion
 Backlog, 529
 Backward pass, 176, 177, 529
 Balanced matrix organization, 23-24
 Bar chart, 182, 183, 529
 Baseline, 76, 88, 140, 529. *See also* Cost baseline; Rebaselining;
 Schedule baseline; Scope baseline
 Baseline schedule, 218. *See also* Schedule baseline
 Basis of estimates, 529
 as input, 210
 as output, 208
 Benchmarking, 116, 239, 529
 Best practices
 benchmarking and, 116, 239
 discretionary dependencies and, 158
 meeting types and, 84
 quality audits and, 247
 systematic achievement of, 7
 Beta distribution, 171, 206
 Bias, risk attitudes and, 311
 Bid(s), 207, 368, 371. *See also* Proposals
 Bidder. *See* Seller(s)
 Bidder conferences, 375, 529
 Bottom-up estimating, 205
 definition, 530
 description of, 164

Boundaries
 process, 241
 project, 54, 424
 Brainstorming, 115, 171, 207, 240
 definition, 530
 meetings and, 84
 risk identification and, 324
 Budget, 365, 530
 Budget at completion (BAC), 89, 218, 219, 530
 Budgeting, 316
 Budget reserve analysis, 211
 Buffer(s), 178, 189. *See also* Reserve
 Buffer management, 178
 Business case, 69, 530
 Business need, 68
 Business partners, 33, 36
 Business requirements, 112, 117
 Business value, 15-16, 530
 Buyer
 definition, 530
 terms for, 357
 Buyer-seller relationship, 357
 Buy versus lease decision, 201

C

CA. *See* Control account
 Calendar, 185. *See also* Project calendar; Resource calendars
 Capability Maturity Model Integrated (CMMI®), 229
 Causal analysis, 91
 Causal influences, 325-326
 Cause-and-effect diagram, 236, 325, 530
 CCB. *See* Change control board
 Central tendency, 530
 Certified Associate in Project Management (CAPM)®, 1
 Change control, 530. *See also* Perform Integrated Change
 Control process
 management reserves and, 213
 meetings, 99
 procedures, 27
 Change control board (CCB), 74, 96, 530
 change management plan and, 96
 meetings and, 99
 Change control system, 531. *See also* Contract change control
 system

- Change control tools, 99, 531
- Change log, 100, 407, 531
- Change management plan/system, 138
- Change request(s).
 - See also* Approved change request; Requested change approved, 528
 - approved change requests review, 528
 - change control board and, 96
 - constructive change, 384
 - corrective actions and, 353
 - definition, 531
 - as input, 97
 - as output, 85, 136, 140, 225, 247, 253, 284–285, 307–308, 370, 378, 385, 408, 413
 - preventive actions and, 191, 353
 - types of, 92–93
 - updates, 348
- Charter. *See* Project charter
- Checklist analysis, 325, 531
- Checklist(s), 254. *See also* Quality checklists
- Checksheets, 237, 531
- Claim, 531
- Claims administration, 384, 531
- Closed procurements, 389, 531
- Close Procurements process, 354, 461, 531
 - inputs, 388
 - outputs, 389
 - overview, 386–387
 - tools and techniques, 388–389
- Close Project or Phase process, 63, 460–461, 531
 - inputs, 102
 - outputs, 103–104
 - overview, 100–101
 - tools and techniques, 102–103
- Closing Process Group, 418
 - definition, 531
 - overview, 57–58, 459–460
 - processes in, 61
- CMMI®. *See* Capability Maturity Model Integrated
- Code of accounts, 132, 531
- Code of Ethics and Professional Conduct*, 1
- Collaboration
 - project manager and, 48, 91, 128, 307
 - virtual collaboration techniques, 25
- Collective bargaining agreements, 203, 268
- Collect Requirements process, 105, 430, 531
 - inputs, 113
 - outputs, 117–119
 - overview, 110–112
 - tools and techniques, 114–117
- Colocated teams, 25, 277, 532
 - See also* Project team(s); Team
- Commercial information, published, 204
- Communication
 - See also* Control Communications process
 - activity, dimensions of, 287
 - channels, 81, 176, 292, 293, 294
 - constraints, 532
 - correspondence, 386
 - diverse stakeholders and, 287
 - informal, 274, 282
 - methods, 294–295, 407, 532
 - models, 293–294, 298, 300, 532
 - organizational, 20
 - project, 301, 305
 - skills, 288
 - styles, 21
 - technology, 38, 292–293, 300
- Communication planning
 - See also* Plan Communications process; Project Communications Management
- Communication requirements analysis, 291–292, 532
- Communications management plan, 296–297, 532
 - as input, 299, 406
- Communication technologies, 38, 292–293, 300, 532
 - See also* E-mail; Web conferencing
- Competency, 264
- Compliance, 267, 532
- Composite organization, 25, 26
- Concurrent project phases, 42
- Conduct Procurements process, 354, 449, 532
 - inputs, 373–375
 - outputs, 377–379
 - overview, 371–373
 - tools and techniques, 375–377
- Confidentiality, 293
- Configuration control, 96
- Configuration identification, 96

- Configuration management plan, 138
- Configuration management system
 - change requests and, 96
 - definition, 532
- Configuration status accounting, 97
- Configuration verification and audit, 97
- Conflict management, 282–283, 532
- Conformance, 235, 532
- Conformance work, 533
- Constraints, 5, 124, 168, 365, 533
- Context diagrams, 117, 533
- Contingency, 533
- Contingency allowance. *See* Reserve
- Contingency plan, 348
- Contingency reserve, 171, 206, 213, 348, 533
 - See also* Reserve analysis
- Contingent response strategies, 346, 533
- Continuous distributions, 337
- Continuous improvement, 229
- Contract(s), 533
 - See also* Time and Material Contract (T&M); Union labor/contracts
 - amendments to, 381
 - closure of, 366, 373, 381
 - communications and, 386
 - cost-reimbursable, 363–364, 535
 - documentation, 389
 - early termination of, 387
 - legal implications of, 203, 357, 380, 387
 - procurement contract, 357
 - procurement negotiations and, 375
 - requirements of, 96, 282, 384
 - termination clause, 378, 380
 - terms and conditions, 387
 - types of, 362–363
- Contract change control system, 383, 533
- Contract management, 355
- Contractor. *See* Seller(s)
- Contractor conferences. *See* Bidder conferences
- Control, 88, 533
- Control account (CA), 132, 533
- Control chart, 238, 533
- Control Communications process, 287, 456–457, 533
 - inputs, 304–306
 - outputs, 307–308
 - overview, 303–304
 - tools and techniques, 306–307
- Control Costs process, 193, 455, 534
 - inputs, 216–217
 - outputs, 225–226
 - overview, 215–216
 - tools and techniques, 217–225
- Control limits, 534. *See also* Specification limits
- Control Procurements process, 354, 458, 534
 - inputs, 381–382
 - outputs, 384–386
 - overview, 379–381
 - tools and techniques, 383–384
- Control Quality process, 227, 456, 534
 - inputs, 250–251
 - outputs, 252–254
 - overview, 248–250
 - tools and techniques, 252
- Control Risks process, 309, 457, 534
 - inputs, 350–351
 - outputs, 353–354
 - overview, 349–350
 - tools and techniques, 351–352
- Control Schedule process, 141, 454–455, 534
 - inputs, 187–188
 - outputs, 190–192
 - overview, 184–187
 - tools and techniques, 188–190
- Control Scope process, 105, 454, 534
 - inputs, 137–138
 - outputs, 139–140
 - overview, 136–137
 - tools and techniques, 139
- Control Stakeholder Engagement process, 391, 458–459, 534
 - inputs, 411–412
 - outputs, 413–415
 - overview, 409–410
 - tools and techniques, 412–413
- Control thresholds, 148, 199
- COQ. *See* Cost of quality
- Corrective action, 81
 - change request for, 85, 93, 353
 - definition, 534

- Correspondence, 386
 - Cost(s). *See also* Actual cost
 - aggregation of, 211, 534
 - indirect, 202, 207, 218, 365
 - and time objectives, 341
 - Cost aggregation, 211, 534
 - Cost baseline, 191, 216, 226, 233, 534
 - as output, 212–214, 385
 - updates, 347
 - Cost-benefit analysis, 235, 535
 - Cost contingency reserve, 207, 349
 - Cost control. *See* Control Costs process
 - Cost estimating. *See* Estimate Costs process
 - Cost forecasts, 89, 225
 - Cost management. *See* Project Cost Management
 - Cost management plan, 216, 226, 534
 - as input, 202, 209, 321, 335
 - updates, 347
 - Cost of quality (COQ), 206, 229, 231, 235, 535
 - Cost performance index (CPI), 89, 219, 535
 - Cost performance measurements, 222
 - Cost Plus Award Fee contract (CPAF), 364, 535
 - Cost-plus contract, 344
 - Cost Plus Fixed Fee (CPFF) contract, 364, 535
 - Cost Plus Incentive Fee (CPIF) contract, 364, 535
 - Cost-reimbursable contracts, 363–364, 535
 - Cost risk simulation, 340
 - Cost variance (CV), 89, 218–219, 535
 - CPAF. *See* Cost Plus Award Fee contract
 - CPFF. *See* Cost Plus Fixed Fee
 - CPI. *See* Cost performance index
 - CPIF. *See* Cost Plus Incentive Fee (CPIF) contract
 - CPM. *See* Critical path method
 - Crashing, 181, 190, 535
 - Create WBS process, 105, 431, 535
 - inputs, 127
 - outputs, 131–132
 - overview, 125–126
 - tools and techniques, 128–131
 - Criteria, 536
 - Critical chain, 178
 - Critical chain method (CCM), 142, 178, 188, 536
 - Critical path, 176, 536
 - Critical path activity, 177, 536
 - Critical path method (CPM), 142, 176–177, 188, 246, 536
 - Cultural diversity
 - cross-cultural considerations, 290
 - multinational team, 294
 - projects characterized by, 274
 - recognition and rewards, 277
 - Culture. *See* Organizational culture
 - Customer(s)
 - definition, 536
 - external, 70, 380
 - in project team, 36
 - request, 9
 - requirements, 228
 - users and, 32
 - Customer satisfaction, 229, 536
 - CV. *See* Cost variance
- D**
- Data date, 536
 - Data gathering and representation techniques, 536
 - interviewing, 336
 - probability distributions, 337
 - Decision making
 - business case and, 69
 - effective, 284
 - quantitative risk information and, 333, 441
 - Decision-making skills, 284
 - Decision tree analysis, 339, 536
 - Decoding/encoding of messages, 293–294
 - Decomposition, 112, 536
 - excessive, 131
 - into work packages, 120–131, 128
 - Dedicated project team, 37
 - Defect(s), 3
 - definition, 536
 - identification of, 237
 - number of, 59, 85, 228
 - prevention of, 229, 243
 - Defect repair, 81
 - change request for, 82, 85, 93, 97, 140
 - definition, 536
 - quality audits and, 247
 - Define Activities process, 141, 432, 536

- inputs, 150–151
- outputs, 152–153
- overview, 149–150
- tools and techniques, 151–152
- Define Scope process, 105, 430, 537
 - inputs, 121–122
 - outputs, 123–124
 - overview, 120–121
 - tools and techniques, 122–123
- Deliverable(s). *See also* Result; Verified deliverables
 - accepted, 102, 135, 389, 526
 - definition, 84, 123, 537
 - as input, 251
 - as output, 84
 - validated, 566
 - verified, 134, 135
- Delphi technique, 171, 207, 324, 537
- Dependency. *See* Logical relationship
- Dependency determination, 537
 - discretionary dependencies, 158
 - external dependencies, 158
 - internal dependencies, 158
 - mandatory dependencies, 157, 545
- Design of experiments (DOE), 239–240, 537
- Determine Budget process, 193, 437, 537
 - inputs, 209–211
 - outputs, 212–214
 - overview, 208–209
 - tools and techniques, 211–212
- Develop Project Charter process, 63, 426, 537
 - inputs, 68–70
 - outputs, 71–72
 - overview, 66–68
 - tools and techniques, 71
- Develop Project Management Plan process, 63, 429, 537
 - inputs, 74–75
 - outputs, 76–78
 - overview, 72–74
 - tools and techniques, 76
- Develop Project Team process, 255, 447, 537
 - inputs, 274–275
 - outputs, 278–279
 - overview, 273–274
 - tools and techniques, 274–278
- Develop Schedule process, 141, 434–435, 537
 - inputs, 175–176
 - outputs, 181–184
 - overview, 172–174
 - tools and techniques, 176–180
- Diagramming techniques, 325–326, 537
- Dictatorship, 115, 537
- Direct and Manage Project Work process, 63, 445–446, 538
 - inputs, 82–83
 - outputs, 84–86
 - overview, 79–81
 - tools and techniques, 83–84
- Discounted cash flow, 195, 198
- Discrete effort, 538
- Discretionary dependencies, 158, 538
- Diversity. *See* Cultural diversity
- Document(s). *See also* Project documents
 - analysis of, 117, 538
 - archival of, 460
 - management, hard-copy, 300
 - phase closure, 104
- Documentation. *See also* Requirements documentation
 - lessons learned, 254, 303, 389, 409, 415
 - reviews, 324, 538
 - seller performance evaluation, 382
 - technical, 348
 - written, 386
- DOE. *See* Design of experiments
- DU or DUR. *See* Duration
- Duration (DU or DUR), 538. *See also* Most likely duration; Optimistic duration; Pessimistic duration
- Duration estimates. *See* Activity duration estimates; Estimate Activity Durations process

E

- EAC. *See* Estimate at completion
- EAC forecasts, 220–221
- Early Finish date (EF), 538
- Early Start date (ES), 538
- Earned value (EV), 132, 218, 219, 538
 - analysis, 224, 351
- Earned value management (EVM), 92, 149, 189
 - cost management plan and, 199

definition, 538
 reports, 96
 work packages, control accounts and, 217–219
 Earned value performance, 223
 EF. *See* Early Finish date
 Effort, 538
 Emotional intelligence, 538
 Employees. *See also* Human resource management plan;
 Staffing management plan
 morale of, 266, 274
 motivation of, 273, 447
 virtual teams and, 271
 EMV. *See* Expected Monetary Value (EMV) analysis
 Encoding/decoding of messages, 293–294
 Enterprise environmental factors, 29, 127, 539
 examples of, 146, 151, 155, 169, 197, 203–204, 234
 as input, 70, 74–75, 82, 90, 98, 108, 163, 176, 259, 269,
 291, 299, 324, 330, 335, 362, 395, 401
 updates, 279, 285
 Environmental consideration, 9
 ES. *See* Early Start date
 Escalation procedures, 259
 Estimate, 376, 539. *See also* Analogous estimating; Basis of
 estimates; Independent estimates; Parametric estimating;
 Three-point estimate
 Estimate Activity Durations process, 141, 433–434, 539
 inputs, 167–169
 outputs, 172
 overview, 165–167
 tools and techniques, 169–171
 Estimate Activity Resources process, 141, 433, 539
 inputs, 162–163
 outputs, 165
 overview, 160–162
 tools and techniques, 164
 Estimate at completion (EAC), 89, 199, 220–221, 539
 Estimate Costs process, 193, 436, 539
 inputs, 202–204
 outputs, 207–208
 overview, 200–202
 tools and techniques, 204–207
 Estimate to complete (ETC), 89, 219–220, 539
 ETC. *See* Estimate to complete
 EV. *See* Earned value

EVM. *See* Earned value management
 Execute, 539
 Executing Process Group, 418, 444–445
 definition, 539
 overview, 56
 processes in, 61
 Expected Monetary Value (EMV) analysis, 339, 539
 Expert judgment, 76, 91, 98–99, 109, 122, 128, 147, 152,
 164, 169, 198, 204, 211, 263, 306–307, 315, 327, 333,
 341, 346, 365, 376, 397–398, 401–402, 412, 539
 External dependencies, 158, 540

F

Facilitated workshops, 114, 123, 540
 Facilitation techniques, 71, 76
 Failure costs, 235
 Failure mode and effect analysis (FMEA), 92, 540
 Fallback plan, 343, 348, 540
 Fast tracking techniques, 43, 147, 158, 181, 190, 540
 Fault tree analysis (FTA), 92
 Fee, 540
 Feeding buffers, 178
 FF. *See* Finish-to-finish
 FFP. *See* Firm-fixed-price contract
 Final product, service, or result transition, 103
 Finish date, 540
 Finish-to-finish (FF), 154, 156, 540
 Finish-to-start (FS), 154, 156, 540
 Firm Fixed Price contract (FFP), 363, 540
 Fishbone diagram, 236, 325. *See also* Cause-and-effect
 diagram
 Fixed formula method, 540
 Fixed-price contracts, 362–363, 540
 Fixed Price Incentive Fee contract (FPIF), 363, 541
 Fixed Price with Economic Price Adjustment contracts (FP-EPA),
 363, 541
 Float. *See* Free float; Total float
 Flowcharts, 236, 541
 FMEA. *See* Failure mode and effect analysis
 Focus groups, 114, 278, 402, 412, 541
 Force field analysis, 240
 Forecast(s)
 cost, 89, 225

- definition, 541
 - schedule, 89, 561
 - Forecasting methods, 92, 220–221
 - Forming, storming, norming, performing, adjourning, 276
 - FP-EPA
 - See Fixed Price with Economic Price Adjustment contract
 - FPIF. See Fixed Price Incentive Fee contract
 - FPP. See Firm Fixed Price contracts
 - Fragment network. See Subnetwork
 - Framework for standard, 418–419
 - Free float, 177, 541
 - FS. See Finish-to-start
 - FTA. See Fault tree analysis
 - Fully plan-driven life cycles. See Predictive life cycle
 - Functional manager, 33, 541
 - Functional organization, 22, 541
 - Function points, 250
 - Funding limit reconciliation, 212, 542
 - Funding requirements, 214
- G**
- Gantt chart, 182, 542
 - Globalization/global environment
 - cultural diversity and, 274
 - cultural influences and, 21
 - international factors, 272
 - Governance. See also Project governance
 - organizational, 13
 - project, 34–35, 553
 - Government jurisdictions, 376. See also Regulatory bodies
 - Government regulations, 68, 267
 - Grade of products/services, 228, 542
 - Graphical analysis techniques, 223
 - Ground rules, project team, 277, 542
 - Group creativity techniques, 115, 542
 - Group decision-making techniques, 115–116, 135, 171, 207, 542
 - Grouping methods, 91
 - Guideline, 542
- H**
- Hammock activity, 182. See also Summary activity
 - Hard logic, 157. See also Mandatory dependency
 - Hierarchical-type organization charts, 261
 - High-level plan, 45, 316
 - High-level project/product description, 72, 108, 121, 314
 - High-level requirements, 55, 71, 117, 314, 425
 - High-level vision, 45, 121
 - High-performance teams, 278
 - Histograms, 238, 265–266, 340, 542
 - Historical information, 104, 542
 - Historical relationships, 212
 - Human resource management plan, 264–267, 542
 - as input, 202, 269, 274, 281, 322
 - roles and responsibilities, 264
 - updates, 347
 - Human resource requirements
 - See Staffing management plan
- I**
- ID. See Activity identifier
 - Idea/mind mapping, 115, 542
 - Identified risks, list of, 327
 - Identify Risks process, 309, 440, 542
 - inputs, 320–324
 - outputs, 327
 - overview, 319–321
 - tools and techniques, 324–327
 - Identify Stakeholders process, 391, 426, 543
 - inputs, 394–395
 - outputs, 398
 - overview, 394–395
 - tools and techniques, 395–398
 - IFB. See Invitation for bid
 - Imposed date, 543
 - Incentive fee, 543
 - Incremental life cycle, 543
 - Independent estimates, 376, 543
 - Indirect costs, 202, 207, 218, 365
 - Inflation allowance, 202, 207
 - Influence diagram, 325–326, 543
 - Influence/impact grid, stakeholder analysis, 396
 - Influencing skills, 284
 - Information. See also Documentation; Project information
 - confidentiality/sensitivity of, 293
 - and report flow, 59

urgency of need for, 292

Information gathering techniques, 324–325, 543

Information management systems, 300, 306, 412, 543
See also Project management information system

Information storage and retrieval
See Corporate knowledge base

Initiating Process Group, 418, 543
 overview, 54–55, 424–425
 processes in, 61
 project boundaries and, 54

Input, 543. *See also* specific process

Inspection(s), 135
 audits and, 383, 543
 description of, 252

Integrated change control
See Perform Integrated Change Control process

Interactive communication, 295

Internal dependencies, 158

International Organization for Standardization (ISO), 228, 418

Interpersonal skills, 17–18, 283–284, 407
 communication skills, 288
 decision making, 284
 definition, 544
 influencing, 284
 leadership, 284
 as “soft skills,” 275

Interrelationship diagrams, 245, 544

Interviews, 114, 325, 336, 544

Invitation for bid (IFB), 368, 544

IPECC, 231

Ishikawa diagrams, 236, 325

ISO. *See* International Organization for Standardization

Issue, 310, 544

Issue log, 544
 as input, 281, 305, 411
 as output, 408, 414

Iterative and incremental life cycles, 45–46

Iterative life cycle, 121, 544

J

JAD

See Joint Application Development (or Design) (JAD) sessions

Joint Application Development (or Design) (JAD) sessions, 114

Joint venture, 19, 37, 347

Judgment. *See* Expert judgment

K

Key performance indicators (KPIs), 84

Knowledge Areas
 mapping of, 422–423
 Process Groups and, 61
 Project Communications Management, 289–290, 553
 Project Cost Management, 192–195, 553
 Project Human Resource Management, 255–257, 554
 Project Integration Management, 63–65, 554
 Project Procurement Management, 355–358, 555
 Project Quality Management, 227, 555
 Project Risk Management, 309–312, 555
 Project Scope Management, 105, 555
 Project Time Management, 142, 556
 role of, 60

Knowledge base, lessons learned, 151, 544

KPIs. *See* Key performance indicators

L

Lag(s), 180
 adjusting, 190, 527
 applying, 528
 definition, 159, 544
 example of, 158

Late finish date (LF), 544

Late start date (LS), 544

Leadership skills, 284

Lead(s), 180
 adjusting, 190, 527
 applying, 528
 definition, 544
 example of, 158

Lean Six Sigma, 229

Legal requirements, 9, 31
 contractual obligations, 203, 361, 380, 387

Lessons learned, 259
 definition, 544
 documentation, 254, 303, 389, 409, 415

- knowledge base, 151, 544
 - Leveling. *See* Resource leveling
 - Level of accuracy, 148, 199
 - Level of effort (LOE), 153, 545
 - Level of precision, 199
 - LF. *See* Late finish date
 - Life cycle. *See* Incremental life cycle; Iterative life cycle; Predictive life cycle; Product life cycle; Project life cycle
 - LOE. *See* Level of effort
 - Log, 545. *See also* Issue log
 - Logical relationship, 154, 159, 545
 - See also* Precedence relationship
 - LS. *See* Late start date
- M**
- Majority, 115, 545
 - Make-or-buy analysis, 360, 365, 545
 - Make-or-buy decisions, 370, 545
 - as input, 374
 - Manage Communications process, 287, 448, 545
 - inputs, 299–300
 - outputs, 300–303
 - overview, 297–299
 - tools and techniques, 300–301
 - Management. *See also* Portfolio management; Program management; Project management; Project Quality Management
 - responsibility, 229
 - skills, 408, 545
 - Management reserve, 171, 206, 213, 545
 - See also* Reserve
 - Manage Project Team process, 255, 448, 545
 - inputs, 280–281
 - outputs, 284–285
 - overview, 279–280
 - tools and techniques, 282–284
 - Manager(s). *See also* Project manager
 - functional, 33, 541
 - program, 14
 - Manage Stakeholder Engagement process, 391, 449–450, 545
 - inputs, 406–407
 - outputs, 408–409
 - overview, 404–406
 - tools and techniques, 407–408
 - Mandatory dependency, 157, 545
 - Market research, 365, 546
 - Master schedule, 546. *See also* Schedule
 - Material, 546
 - Matrix-based responsibility charts, 262
 - Matrix diagrams, 246, 546
 - Matrix organization(s), 21, 22–24, 546
 - Meetings, 307, 352, 398, 402
 - change control board and, 99
 - participants in, 109, 148, 198, 241
 - potential bidders and, 366
 - project-related, 295
 - risk management and, 316
 - status review, 297, 352, 413
 - types of, 84, 92, 103
 - “war room” for, 277
 - Methodology, 546
 - Metrics. *See* Quality metrics
 - Milestone. *See also* Weighted milestone method
 - closure of phase, 41
 - definition, 546
 - zero duration of, 153
 - Milestone charts, 182, 183
 - Milestone list, 546
 - as input, 155
 - as output, 153
 - Milestone schedule, 546. *See also* Master schedule
 - Mind mapping, 115, 542
 - Mitigation. *See* Risk mitigation
 - Modeling
 - simulation and, 340
 - techniques, 180, 189
 - Monitor, 546
 - Monitor and Control Project Work process, 63, 452, 546
 - inputs, 88–91
 - outputs, 92–94
 - overview, 86–88
 - tools and techniques, 91–92
 - Monitoring and Controlling Process Group, 418, 546
 - as “background” process, 50
 - overview, 57, 450–451
 - processes in, 61
 - project or phase closure, 57

Monte Carlo simulation, 171, 340, 547

Most likely duration, 547. *See also* Duration

Multi-criteria decision analysis, 115, 271–272, 547

Multiphase projects, 51, 57, 69, 387, 419, 451

N

Near-critical activity, 547

Negative risks, 203, 310, 311, 344–345

Negotiated settlements, 547

Negotiation, 547

invitation for, 368

procurement, 377

staff assignments and, 270

Network. *See* Project schedule network diagram

Network analysis. *See* Schedule network analysis

Networking, 263, 547

Network logic, 547

Network path, 547

Network schedule analysis activity, 176

Node, 547

Nominal group technique, 115, 171, 207, 240, 547

Nonconformance, 229

cost of, 235

work, 548

O

Objective, 548

OBS. *See* Organizational breakdown structure

Observations, 116, 282, 548

Operational stakeholders, 13–14

Operations management, 12

OPM. *See* Organizational Project Management

OPM3®. *See* Organizational Project Management Maturity Model

Opportunities, 345–346, 548

Optimistic duration, 548. *See also* Duration

Organization(s)

project management and, 14–15

Organizational breakdown structure (OBS), 245, 261, 548

Organizational characteristics, 21–26

Organizational charts, 131, 258, 292

Organizational culture. *See also* Cultural diversity

project team composition and, 37

styles and, 20–21

Organizational groups, 33

Organizational knowledge base. *See* Corporate knowledge base

Organizational procedures links, 148, 199

Organizational process assets, 23–24

corporate knowledge base, 28

definition, 548

examples of, 147, 151, 156, 163, 169, 217, 234, 251

as input, 70, 75, 83, 91, 98, 102, 109, 122, 127, 139, 188,

197, 204, 211, 259, 281, 291, 299–300, 306, 324, 330,

336, 362, 375, 395, 401, 407

processes and procedures, 27–28

updates, 103, 140, 192, 226, 248, 254, 285, 302–303, 308,

354, 389, 409, 415

Organizational project management (OPM), 7

Organizational project management maturity, 548

Organizational strategy

project management, operations management and, 11

project management and, 15

Organizational structures, 21–26

composite organization, 26

functional organization, 22

interactions and, 26

matrix organizations, 22–24

overlapping project phases, 43–44

projectized organization, 25

project-related characteristics, 21

reporting relationships and, 17

Organizational theory, 263

Organization charts and position descriptions, 261–262

hierarchical-type charts and, 261

matrix-based charts, 262

text-oriented formats, 262

Output(s), 548

Overlapping project phases, 43

P

Parametric estimating, 170, 205, 548

Pareto diagram, 237, 548

Path convergence, 548

Path divergence, 548

Payment systems, 383, 548

PBOs. *See* Project-based organizations (PBOs)

- PDCA. *See* Plan-do-check-act (PDCA) cycle
- PDM. *See* Precedence Diagramming Method
- PDPC. *See* Process Decision Program Charts (PDPC)
- Percent complete, 549
- Performance appraisals, 282
- Performance measurement baseline (PMB), 302, 549
- Performance reporting, 300, 383.
See also Work performance reports
- Performance reviews, 188–189, 222–223, 549
 procurement, 383, 552
- Performing organization, 549. *See also* Seller(s)
- Perform Integrated Change Control process, 63, 452–453, 549
 inputs, 97–98
 outputs, 99–100
 overview, 94–97
 tools and techniques, 98–99
- Perform Qualitative Risk Analysis process, 309, 440–441, 549
 inputs, 329–330
 outputs, 333
 overview, 328–329
 tools and techniques, 330–333
- Perform Quality Assurance process, 227, 446, 549
 inputs, 244–245
 outputs, 247–248
 overview, 242–244
 tools and techniques, 245–247
- Perform Quantitative Risk Analysis process, 309, 441, 549
 inputs, 335–336
 outputs, 341
 overview, 333–335
 tools and techniques, 336–341
- Personnel assessment tools, 278
- PERT. *See* Program Evaluation and Review Technique
- Pessimistic duration, 549. *See also* Duration
- Phase. *See* Project phase(s)
- Phase closure, 104. *See also* Close Project or Phase process
- Phase gate, 41, 549
- Phase-to-phase relationships, 42–44
 overlapping relationship, 43
 sequential relationship, 42
- Plan Communications Management process, 287, 439, 549
 inputs, 290–291
 outputs, 296–297
 overview, 289–290
 tools and techniques, 291–295
- Plan Cost Management process, 193, 435–436, 550
 inputs, 196–197
 outputs, 198–200
 overview, 195–196
 tools and techniques, 198
- Plan-do-check-act (PDCA) cycle, 229
- Plan Human Resource Management process, 255, 438, 550
 inputs, 259–260
 overview, 258–259
 tools and techniques, 261–264
- Planned risk responses, 104, 347–348
- Planned value (PV), 218, 219, 550
- Planning package, 132, 550. *See also* Control account
- Planning Process Group, 418, 550
 overview, 55–56, 427–428
 processes in, 61
- Plan Procurement Management process, 354, 442–443, 550
 inputs, 360–364
 outputs, 366–370
 overview, 358–360
 tools and techniques, 355–356
- Plan Quality Management process, 227, 437–438, 550
 inputs, 233–234
 outputs, 241–242
 overview, 230–233
 tools and techniques, 235–241
- Plan Risk Management process, 309, 430, 550
 inputs, 314–315
 outputs, 316–318
 overview, 313–314
 tools and techniques, 315–316
- Plan Risk Responses process, 309, 442, 550
 inputs, 343
 outputs, 346–347
 overview, 342–343
 tools and techniques, 343–346
- Plan Schedule Management process, 141, 431, 550
 inputs, 146–147
 outputs, 148–149
 overview, 145–146
 tools and techniques, 147–148
- Plan Scope Management process, 105, 429, 550
 inputs, 108–109

- outputs, 109–110
 - overview, 107–108
 - tools and techniques, 109
- Plan Stakeholder Management process, 391, 443, 550
 - inputs, 400–401
 - outputs, 403–404
 - overview, 399–400
 - tools and techniques, 401–403
- Plurality, 115, 550
- PM. *See* Project manager
- PMB. *See* Performance measurement baseline; PV baseline
- PMIS. *See* Project Management Information System
- PMO. *See* Project management office
- Policy, 550
- Portfolio, 551
- Portfolio management, 551
- Positive risks, 311, 345–346
- Power/influence grid, stakeholder analysis, 396
- Power/interest grid, stakeholder analysis, 396
- Pre-assignment of team members, 270
- Pre-bid conferences. *See* Bidder conferences
- Precedence Diagramming Method (PDM), 156–157, 246, 551
- Precedence relationship, 156–157, 551.
 - See also* Logical relationship
- Precision, 228, 551
- Predecessor activity, 156, 158–159, 180, 551
- Predictive life cycle, 44–45, 551
- Preferential logic, 158. *See also* Discretionary dependencies
- Presentations, 302, 409, 415
- Prevention, 229, 250
- Preventive action, 81, 551
 - change request for, 93, 191, 353
 - characteristics of, 85
- Prioritization matrices, 246, 551
- Probabilistic analysis of project, 341
- Probability and impact matrix, 318, 331–332, 551
- Probability distributions, 337
- Procedure, 551
- Process analysis, 247, 552
- Process assets. *See* Organizational process assets
- Process closure. *See* Closing Process Group
- Process Decision Program Charts (PDPC), 245, 552
- Process(es)
 - definition, 551
 - descriptions of, 50, 149, 200
- Processes and procedures, 27–28
 - See also* specific process or procedure
- Process flow charts, 325
- Process flow diagram, 419–420
- Process Groups
 - categories of, 48–49
 - Closing Process Group, 57–58
 - Executing Process Group, 56
 - Initiating Process Group, 54–55
 - interactions of, 51, 420–421
 - Knowledge Areas mapping and, 61
 - Monitoring and Controlling Process Group, 57
 - as overlapping activities, 51
 - overview, 5, 52–53
 - Planning Process Group, 55–56
- Process improvement models, 229
- Process improvement plan, 552
 - as input, 244
 - as output, 241
- Process interactions.
 - See* Project management process interactions
- Procurement audits, 388, 552
- Procurement documents, 552
 - as input, 323, 373, 382, 388, 394
 - as output, 368
 - procurement contract, 357, 380
- Procurement file, 389
- Procurement management plan, 552
 - as input, 373
 - as output, 366–367, 385
 - updates, 347
- Procurement negotiations, 377, 388
- Procurement performance reviews, 383, 552
- Procurement statement of work, 552
 - as input, 374
 - as output, 367
- Product, 552
- Product analysis, 122, 552
- Product life cycle, 552
- Product-oriented processes, 47–48
- Product quality improvement, 229
- Product requirements, 64, 106, 114, 115, 118, 227
- Product scope, 105, 552

- Product scope description, 68, 123, 552
- Program(s), 553
- Program Evaluation and Review Technique (PERT), 170, 246, 553
- Program management
 - definition, 553
 - description of, 9
 - OPM and, 6
 - portfolio management and, 6–7
 - project management and, 6–7
- Program manager, 14
- Progressive elaboration, 5
 - definition, 553
 - project management plan and, 55
 - prototypes and, 116
 - rolling wave planning as, 151
- Project(s)
 - boundaries, 54, 424
 - definition, 3–4, 417, 553
 - portfolios, programs and, 4–5
 - temporary nature of, 35
- Project-based organizations (PBOs), 14, 553
- Project boundaries, 54, 424
- Project calendar, 553
 - as input, 188
 - as output, 184
- Project charter, 553. *See also* Develop Project Charter process
 - authorization and, 54, 424
 - description of, 67
 - as input, 74, 108, 113, 121, 146, 197, 394
 - as output, 71–72
 - project scope statement and, 124
- Project closure
 - documents, 104, 354
 - guidelines, 75
- Project communication requirements.
 - See* Communication requirements analysis
- Project communications, 301, 305
- Project Communications Management, 287–308
 - definition, 553
 - overview, 287–288
- Project Cost Management, 193–226, 553
- Project documents. *See also* Documents
 - as input, 245, 251, 323, 374, 411–412
 - project management plan and, 78
 - updates, 86, 94, 100, 125, 132, 136, 140, 160, 165, 172, 185, 191, 208, 214, 226, 242, 248, 285, 297, 302, 308, 333, 341, 354, 370, 379, 385, 404, 409
- Project execution. *See* Executing Process Group
- Project files, 104
- Project funding requirements, 553
 - as input, 217
 - as output, 214
- Project governance, 34–35, 553. *See also* Governance
- Project Human Resource Management, 255–285, 554
- Project initiation, 554
- Project Integration Management, 63–104
 - definition, 554
 - overview, 63–65
- Projectized organization, 25, 556
- Project life cycle
 - adaptive life cycles, 46
 - characteristics of, 38–40
 - cost, staffing levels and, 39–40
 - definition, 38, 554
 - iterative and incremental life cycles, 45–46
 - overview, 38
 - predictive life cycles, 44–45
 - project time and, 39
- Project management
 - business value and, 16
 - definition, 417, 554
 - description of, 5–6
 - iterative nature of, 422
 - operational stakeholders in, 13–14
 - operations management and, 12
 - organizational governance and, 13
 - organizational influences on, 19
 - organizational strategy and, 11, 15
 - organizations and, 14–15
 - Process Groups in, 5
 - process interactions, 50–51, 53, 422–423
- Project management body of knowledge, 554
- Project management information system (PMIS), 57, 58, 92, 151, 155, 460, 554
- Project Management Knowledge Areas, 554
- Project management office (PMO), 99, 554
- Project management plan, 554.

- See also* Develop Project Management Plan process
 - components and project documents, 78
 - cost control and, 216
 - cost management plan and, 196
 - elements of, 146
 - as input, 82, 88–89, 97, 102, 108, 134, 187, 233, 250, 259, 290, 304–305, 314, 350, 360, 381, 388, 400, 411
 - as output, 76–77, 140
 - progressive detailing of, 55
 - schedule management plan and, 142
 - scope control and, 138
 - updates, 85–86, 93, 100, 140, 184, 191, 225–226, 248, 253, 272, 284, 302, 308, 346–347, 353, 379, 385, 408, 413–414
- Project management processes
 - categories of, 48–49, 418
 - interactions, 50–51, 53
 - mapping of, 422–423
 - overview, 47–49
- Project Management Process Groups. *See also* Process Groups
 - definition, 554
 - and Knowledge Area Mapping, 422–423
 - linked by outputs, 419
- Project management software, 154, 164, 189, 207, 225
- Project management staff, 555
- Project management system, 555
- Project management team, 77, 555.
 - See also* Project team(s)
- Project management tools, electronic, 300
- Project manager (PM)
 - definition, 555
 - interpersonal skills, 17–18
 - responsibilities/competencies, 17
 - role of, 12, 16–17
- Project objectives, agreed upon, 278
- Project organization chart, 265, 555
- Project performance appraisals, 282
- Project phases, 41–46, 555
 - overlapping of, 43
 - overview, 41–42
 - phase-to-phase relationships, 42–44
 - sequential relationship, 42–43
 - single-phase project, 42
- Project presentations, 302, 409, 415
- Project Procurement Management, 355–389
 - definition, 555
 - overview, 355–358
- Project Quality Management, 227–254
 - See also* Quality management plan
 - definition, 555
 - overview, 227–231
- Project records, 302, 409, 415
- Project reports, 302, 409, 415
- Project requirements, 112, 118
- Project risk, 310
- Project Risk Management, 309–354
 - definition, 555
 - overview, 309–312
- Project schedule, 191, 555
 - development, 142
 - as input, 187, 203, 210, 361
 - as output, 182–184
 - presentation, 142
- Project schedule model
 - development, 148
 - maintenance, 148
- Project schedule network diagram, 182
 - definition, 555
 - description of, 159–160
 - as input, 175
- Project scope, 105, 555. *See also* Control Scope process; Define Scope process; Verify Scope process
- Project scope creep, 108. *See also* Verify Scope process
- Project Scope Management, 105–140, 555
 - overview, 105–106
- Project scope statement, 105, 131, 202, 210, 233
 - assumptions and constraints, 168
 - contents of, 360
 - definition, 556
 - as input, 127, 155, 175
 - as output, 123–124
 - project charter and, 124
- Project sponsor, 32
- Project staff assignments
 - as input, 175, 275, 281
 - as output, 272
- Project Stakeholder Management, 391–415
 - definition, 556

overview, 391–392

Project stakeholders. *See* Stakeholder(s)

Project statement of work. *See* Statement of work

Project team(s).

- colocation of, 25, 277, 532
- composition of, 37–38
- definition, 556
- influencing, 256
- multinational, 294
- pre-assignment of members, 270
- professional and ethical behavior, 256
- roles of members of, 36
- stakeholders and, 30–31
- virtual, 25, 38, 271

Project team directory, 556

Project Time Management, 141–192

- definition, 556
- overview, 141–144

Proposal(s). *See* Seller proposals

Proposal evaluation techniques, 375, 556

Proprietary rights, 369

Prototypes, 116, 556

Pull communication, 295

Push communication, 295

PV. *See* Planned value

PV baseline (PMB)

Q

QFD. *See* Quality Function Deployment

Qualified seller list, 386

Qualitative analysis, 343.

- See also* Perform Quantitative Risk Analysis process

Quality, 228.

- See also* Plan Quality process; Seven basic quality tools
- audits for, 247, 556
- definition, 556

Quality assurance. *See* Perform Quality Assurance process

Quality audits, 247, 556. *See also* Audits

Quality checklists, 556

- as input, 250
- as output, 242

Quality control measurements, 556

- as input, 244

- as output, 252

Quality function deployment (QFD), 114, 556

Quality management. *See* Project Quality Management

Quality management and control tools, 240, 245–246, 556

Quality management plan, 557.

- See also* Project Quality Management
- as input, 244, 321
- as output, 241
- updates, 347

Quality management system, 557

Quality metrics, 557

- as input, 244, 250
- as output, 242

Quality planning tools, 527.

- See also* Additional quality planning tools

Quality policy, 557

Quality requirements, 112, 557

Quality standards. *See* Standard

Quality tools. *See* Seven basic quality tools

Quantified risks, prioritized list of, 341

Quantitative risk analysis and modeling techniques, 338–340, 557

- expected monetary value (EMV) analysis, 339
- modeling and simulation, 340
- sensitivity analysis, 338

Quantitative risk analysis results, trends in, 341

Questionnaires and surveys, 116, 557

R

RACI. *See* Responsible, accountable, consult and inform (RACI) chart

RAM. *See* Responsibility assignment matrix

RBS. *See* Resource breakdown structure; Risk Breakdown Structure

Rebaselining, 444. *See also* Baseline

Recognition and rewards, 266, 277

Records, project, 302, 409, 415

Records management system, 384, 389, 557

Regression analysis, 91, 103, 557

Regulation, 557

Regulatory bodies, 398, 402.

- See also* Government regulations

Report(s)

- information flow and, 59

- project, 302, 409, 415
- work performance, 59, 97
- Reporting formats, 149, 200, 318
- Reporting systems, 557
- Requested change, 558. *See also* Change requests
- Request for information (RFI), 68, 368, 557
- Request for proposal (RFP), 68, 368, 558
- Request for quotation (RFQ), 368, 558
- Requirement(s). *See also* Product requirements
 - definition, 558
 - types of, 112
- Requirements documentation, 558.
 - See also* Collect Requirements process; Contracts
 - as input, 121, 127, 134, 138, 234, 361
 - as output, 117
- Requirements management plan, 110, 113, 138, 558
- Requirements traceability matrix, 558
 - as input, 134, 138
 - as output, 118–119
- Reserve, 558. *See also* Management reserve
- Reserve analysis, 92, 171, 206, 211, 225, 352, 558.
 - See also* Contingency reserve
- Residual risk, 350, 558
- Resolution of conflicts. *See* Conflict management
- Resource(s), 163, 558
- Resource assignments, 182
- Resource breakdown structure (RBS), 261, 558
 - as input, 168, 175
 - as output, 165
- Resource calendars, 558
 - as input, 163, 168, 175, 210, 275
 - as output, 272, 378
 - staffing management plan and, 265
- Resource histogram, 265–266, 559
- Resource leveling, 179, 559
- Resource optimization techniques, 179–180, 189, 559
- Resource requirements. *See* Activity resource requirements;
 - Human resource requirements
- Resource smoothing, 180, 559
- Responsibility, 264, 316, 559
- Responsibility assignment matrix (RAM), 262, 559
- Responsible, accountable, consult, and inform (RACI) chart, 262
- Result, 559. *See also* Deliverable(s)
- Result transition, 103
- Reviews. *See also* Performance reviews; Program Evaluation
 - and Review Technique
 - approved change requests, 252, 528
 - documentation, 324, 538
 - peer, 252
 - procurement performance, 383, 552
 - product, 135
 - risk, 354
- Rewards. *See* Recognition and rewards
- Rework, 235, 559
- RFI. *See* Request for information
- RFP. *See* Request for proposal
- RFQ. *See* Request for quotation
- Risk, 559. *See also* Negative risks; Opportunities;
 - Positive risks; Threat(s)
- Risk acceptance, 345–346, 559
- Risk analysis. *See also* Perform Qualitative Risk Analysis
 - process; Perform Quantitative Risk Analysis process
- Risk appetite, 311, 559
- Risk audits, 351, 354, 559
- Risk avoidance, 344, 559
- Risk breakdown structure (RBS), 245, 317, 324, 560
- Risk categorization, 332, 560
- Risk category, 317, 560
- Risk data quality assessment, 332, 560
- Risk event, 52, 163, 203, 225
- Risk identification. *See* Identify Risks process
- Risk impact. *See* Probability and impact matrix
- Risk management. *See also* Project Risk Management
- Risk management plan, 560.
 - See also* Plan Risk Management process
 - as input, 321, 329, 335, 343
 - as output, 316–318
- Risk mitigation, 345, 560
- Risk probability and impact, 317, 330
- Risk reassessment, 351, 354, 560
- Risk register, 191, 330, 560
 - identified risks list, 327
 - as input, 163, 168, 175, 203, 210, 234, 330, 335, 343, 350, 361
 - as output, 185
 - potential responses list, 327
 - updates, 333, 341
- Risk responses, 311, 354.

See also Plan Risk Responses process

Risk reviews, 354

Risks, secondary, 343, 348, 562

Risk score, 332

Risk threshold, 311, 560

Risk tolerance, 311, 329, 560

Risk transference, 344, 560

Risk urgency assessment, 332, 560

Role(s), 264, 316, 560

Rolling wave planning, 45, 131, 152, 560

ROM. *See* Rough order of magnitude

Root cause analysis, 92, 325, 561

Rules of performance measurement, 149, 199

S

Safety, 267

Salience model, stakeholder analysis, 396

Scatter diagram, 238, 561

Schedule, 561.

See also Master schedule; Project schedule;

Schedule model

Schedule baseline, 191, 196, 233, 561.

See also Baseline schedule; Control Schedule process

as output, 181, 385

updates, 347

Schedule compression, 190, 561

Schedule compression techniques

crashing, 181

fast tracking, 158, 181

Schedule control. *See* Control Schedule process

Schedule data, 142, 191, 561

as input, 188

as output, 184

Schedule development. *See* Develop Schedule process

Schedule forecasts, 561

as input, 89

as output, 190

Schedule management plan, 142, 561.

See also Develop Schedule process criteria and activities

established by, 148–149

as input, 150, 154, 162, 167, 175, 321, 335

updates, 191, 347

Schedule model, 142, 561

Schedule network analysis, 561. *See also* Backward pass;

Critical chain method; Critical path method; Resource leveling

Schedule network templates, 561

Schedule performance index (SPI), 89, 149, 189, 219, 561

Schedule variance (SV), 89, 149, 189, 218, 561

Scheduling

methods, 142, 151

overview, 142, 144

Scheduling software, 158, 177

Scheduling tool, 181, 190, 561

Scope, 562. *See also* Product scope; Project scope

Scope baseline, 101, 138, 146, 196, 562. *See also* Control

Scope process

elements of, 233

as input, 151, 202–203, 210, 322, 329

as output, 131–132

updates, 140, 347

Scope change, 48, 562

Scope creep, 137, 562

Scope management plan, 138, 562

as input, 113, 121, 127

as output, 109–110

Scope statement. *See* Project scope statement

Secondary risks, 343, 350, 562

Selected sellers, 377, 562

Seller(s), 33. *See also* Buyer-seller relationship;

Project Procurement Management

definition, 562

performance-related documentation, 382

prequalified, 361

in project team, 36

qualified seller list, 386

selected, 377, 562

Seller performance evaluation documentation, 382

Seller proposals

definition, 562

as input, 373

Sensitivity analysis, 338, 562

Sequence Activities process, 141, 432, 562

inputs, 154–156

outputs, 159–160

overview, 153–154

tools and techniques, 156–159

Sequencing, 154

- Sequential relationship, 42–43
- Service level agreements (SLAs), 70
- Seven basic quality tools (7QC Tools), 236–239, 252, 562
 - cause-and-effect diagrams, 236
 - checksheets, 237
 - control charts, 238
 - flowcharts, 236
 - histograms, 238
 - scatter diagrams, 238
 - storyboard illustrating, 239
- SF. *See* Start-to-finish
- Simulation, 180, 562
- Single-phase project, 42
- SIPOC model, 236, 237
- Slack. *See* Free float; Total float
- SLAs. *See* Service level agreements
- Slippage, 178
- SMEs. *See* Subject matter experts
- Soft logic, 158. *See also* Discretionary dependency
- Soft skills, 275
- Software, 306. *See also* Project management software;
- Scheduling software
- Software development, 116
 - grade and quality, 228
 - subsystem interfaces, 155
- Solution requirements, 112, 118
- Source selection criteria, 368–369, 373, 563
- SOW. *See* Statement of work
- Specification, 563
- Specification limits, 563. *See also* Control limits
- SPI. *See* Schedule performance index
- Sponsor, 563. *See* Project sponsor
- Sponsoring organization, 563
- SS. *See* Start-to-start
- Staffing management plan, 258–259, 265–267, 563.
 - See also* Human resource management plan;
- Stage gate, 41
- Stakeholder(s), 30–33.
 - See also* Identify Stakeholders process; Manage Stakeholder Engagement process; Project stakeholder definition, 563
 - engagement level of, 402–403
 - examples of, 33
 - expectations, 31
 - external, 34, 54, 371, 424
 - internal, 33, 54, 371, 424
 - key, 93, 114, 117, 248, 277, 395
 - requirements, 112, 117
 - tolerances, 318
- Stakeholder analysis, 395–397, 563
- Stakeholder management plan, 563
 - as input, 113, 406
 - as output, 403–404
- Stakeholder notifications, 302, 409, 415
- Stakeholder register, 563
 - as input, 113, 234, 291, 322, 361, 400
 - as output, 398, 414
- Standard, 563
- Start date, 564
- Start-to-finish (SF), 156, 564
- Start-to-start (SS), 154, 156, 564
- Statement of work (SOW), 68, 367, 564
- Statistical sampling, 240, 252, 564
- Storyboarding, 116, 239, 246
- Strategic planning
 - organizational strategy and, 11
 - statement of work and, 68
- Strengths, weaknesses, opportunities and threats.
 - See* SWOT analysis
- Strong matrix organizations, 24
- Subcontractors, 270
- Subject matter experts (SMEs), 71, 99, 315, 398
- Subnetwork, 564
- Subproject, 564
- Subsidiary plans, 77, 88
- Successor activity, 156, 158–159, 180, 564
- Summary activity, 564
- Supplier. *See* Seller(s)
- Surveys, 116, 557
- SV. *See* Schedule variance
- SWOT analysis, 326, 564
- System or process flow charts, 325

T

- T&M. *See* Time and Material Contract
- Tailor, 564
- Tailoring, 48, 459

TCPI. *See* To-complete performance index
 Team. *See* Colocated teams; Develop Project Team process;
 Project management team; Project team(s)
 Team-based approaches, 171, 207
 Team-building activities, 276
 Team performance assessments, 278–279, 281
 Teamwork, 274. *See also* Develop Project Team process
 Technical documentation, 382
 Technical documentation updates, 348
 Technical performance measurement, 352
 Technique, 564
 Templates, 564
 Text-oriented formats, roles and responsibilities, 262
 Threat(s)
 definition, 564
 strategies for, 344–345
 Three-phase project, 42–43
 Three-point estimate, 170–171, 205–206, 565
 Threshold, 565
 Time and Material Contract (T&M), 364, 565
 Time management. *See* Project Time Management
 Time-scaled schedule network diagram, 565
 To-complete performance index (TCPI), 221–222, 565
 Tolerance, 250, 565
 Tools, 300, 565. *See also* Seven basic quality tools
 Tornado diagram, 338, 565
 Total float, 158, 177, 565
 Total Quality Management (TQM), 229
 TQM. *See* Total Quality Management
 Training, 275
 Training needs, 266
 Transition requirements, 112, 118
 Tree diagram, 245, 565
 Trend analysis, 92, 103, 188, 223, 352, 566
 Triangular distribution, 171, 206
 Trigger condition, 566
 Tuckman ladder of team development, 276

U

Unanimity, 115, 566
 Union labor/contracts, 203. *See also* Contracts
 Updates, change request for, 85
 User(s)

customers and, 32
 in project team, 36

V

VAC. *See* Variance at completion
 Validated changes, 90, 252
 Validated deliverables, 566
 Validate Scope process, 105, 453, 566
 inputs, 134–135
 outputs, 135–136
 overview, 133–134
 tools and techniques, 135
 Validation, 566
 Value, business, 15–16
 Value analysis, 122, 352.
 See also Expected Monetary Value (EMV) analysis
 Value engineering, 566
 Variance, 566
 Variance analysis, 92, 139, 189, 222, 352, 566
 Variance at completion (VAC), 566
 Variation, 566
 Velocity, 566
 Vendor. *See* Seller(s)
 Vendor bid analysis, 207
 Vendor conferences. *See* Bidder conferences
 Verification, 566
 Verified deliverables, 134
 as input, 135
 as output, 253
 Virtual meetings, 84
 Virtual project teams
 collaboration techniques and, 25, 38
 virtual team model, 271
 VOC. *See* Voice of the Customer
 Voice of the Customer (VOC), 114, 566

W

Watch list, risks and, 330, 332, 333, 343, 347–348, 350
 WBS. *See* Work breakdown structure
 WBS dictionary, 105, 132, 202, 210, 233, 360, 567
 WBS ID, 153
 Weak matrix organizations, 22

- Weighted milestone method, 567
- What-if scenario analysis, 180, 567
- Workaround, 567
- Work authorization, 567
- Work authorization system, 146, 567
- Work breakdown structure (WBS), 105, 202, 210.
 - See also* Create WBS process
 - bottom-up approach, 129
 - contents of, 360
 - definition, 567
 - description of, 132, 233
 - hierarchical-type charts and, 261
 - top-down approach, 129
- Work breakdown structure component, 567
- Work packages, 128, 150, 165, 567
- Work performance data, 59, 81, 567
 - as input, 135, 139, 187, 217, 251, 305, 351, 382, 411
 - as output, 85
- Work performance information, 59, 567
 - as input, 90, 382
 - as output, 136, 139, 190, 225, 253, 307, 353, 384, 413
- Work performance reports, 59, 567
 - as input, 97, 281, 299, 351, 382
 - as output, 93
- Workshops. *See* Facilitated workshops
- Written documentation, 386

